

QUALITY RELIABILITY PERFORMANCE

ANNUAL REPORT 2018

INTRODUCTION

OUR VISION

TO OUR SHAREHOLDERS

CONSOLIDATED
MANAGEMENT REPORT

CONSOLIDATED
FINANCIAL STATEMENTS

FURTHER INFORMATION

02 NORMA Group

03 Table of Contents

04 Two Strong
Distribution Channels

05 Financial Figures 2018

INTRODUCTION

NORMA GROUP

NORMA Group is an international market and technology leader in engineered joining technology (joining, connecting and fluid handling technology) and offers more than 40,000 high-quality products and solutions to around 10,000 customers in more than 100 countries. NORMA Group's joining products are used in various industries and can be found in vehicles, ships, trains, aircraft, domestic appliances, engines and plumbing systems as well as in applications for the pharmaceutical and biotechnology industry. From its headquarters in Maintal near Frankfurt, Germany, the Company coordinates a global network consisting of 30 production facilities as well as numerous sales and distribution sites across Europe, the Americas, and Asia-Pacific.

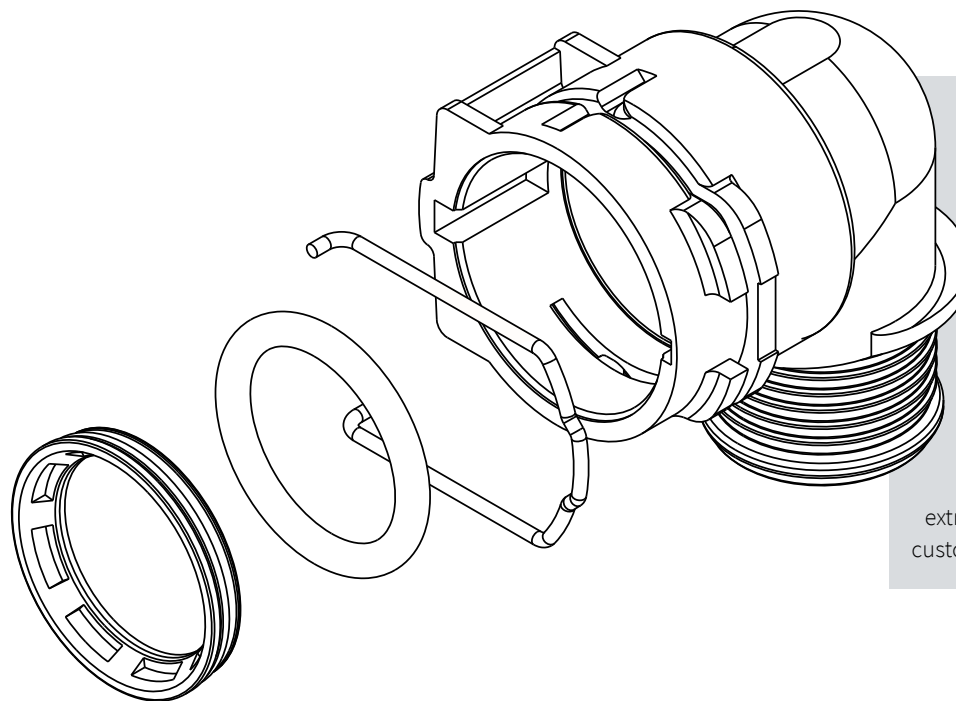

COVER PICTURE

PS3 'PUSH & SEAL' QUICK CONNECTOR

The plastic PS3 Quick Connectors 'Push & Seal' are ideal for the safe and leakage-free connection of coolant and heating hoses as well as charge air systems in automobiles.

Thanks to their intelligent design, they can be quickly and automatically assembled even in extremely tight environments. This allows the end customer significant time and cost advantages.

INTRODUCTION

OUR VISION

TO OUR SHAREHOLDERS

CONSOLIDATED
MANAGEMENT REPORT

CONSOLIDATED
FINANCIAL STATEMENTS

FURTHER INFORMATION

02 NORMA Group

03 Table of Contents

04 Two Strong
Distribution Channels

05 Financial Figures 2018

TABLE OF CONTENTS

INTRODUCTION

NORMA Group	02
Table of Contents	03
Two Strong Distribution Channels	04
Financial Figures 2018	05

OUR VISION

Our Vision	06
Targets – Results – Outlook	07
Quality	08
Reliability	33
Performance	102

TO OUR SHAREHOLDERS

The Management Board	12
Letter from the Management Board	13
NORMA Group on the Capital Market	15
Supervisory Board Report	20
Corporate Governance Report	25

CONSOLIDATED MANAGEMENT REPORT

Principles of the Group	37
Economic Report	51
Forecast Report	74
Risk and Opportunity Report	79
Remuneration Report	91
Other Legally Required Disclosures	98
Report on Transactions with Related Parties	101

CONSOLIDATED FINANCIAL STATEMENTS

Consolidated Statement of Comprehensive Income	106
Consolidated Statement of Financial Position	107
Consolidated Statement of Cash Flows	108
Consolidated Statement of Changes in Equity	109
Notes to the Consolidated Financial Statements	110
Appendix to the Notes to the Consolidated Financial Statements	197
Responsibility Statement	200
Independent Auditor's Report	201

FURTHER INFORMATION

Glossary	207
List of Graphics	211
List of Tables	212
Overview by Quarter 2018	215
Multi-Year Overview	216
Financial Calendar, Contact and Imprint	218



INTRODUCTION

OUR VISION

TO OUR SHAREHOLDERS

CONSOLIDATED
MANAGEMENT REPORT

CONSOLIDATED
FINANCIAL STATEMENTS

FURTHER INFORMATION

02 NORMA Group

03 Table of Contents

**04 Two Strong
Distribution Channels**

05 Financial Figures 2018

TWO STRONG DISTRIBUTION CHANNELS

Innovative joining technology and the highest quality standards have secured NORMA Group's market position for over 70 years now. The Company offers solutions for many different industries with its advanced products. In fact, NORMA Group ranks as one of the world's market and technology leaders in the area of joining technology thanks to the personal dedication of more than 8,800 employees and an intellectual property rights portfolio that consists of more than 1,000 patents.

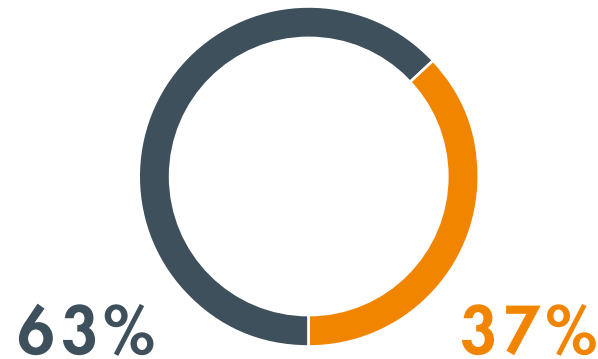

ENGINEERED JOINING TECHNOLOGY (EJT)

The business area of EJT focuses on customized, engineered solutions which meet the specific requirements of original equipment manufacturers (OEM). For these customers, NORMA Group develops innovative, value-adding solutions for a wide range of application areas and various industries. No matter whether it's a single component, a multi-component unit or a complex system, all products are individually tailored to the exact requirements of the industrial customers while simultaneously guaranteeing the highest quality standards, efficiency and assembly safety. NORMA Group's EJT products are built on the Company's extensive engineering expertise and proven leadership in this field.

DISTRIBUTION SERVICES (DS)

In the area of DS, NORMA Group sells a wide range of high-quality, standardized joining technology products for various applications through different distribution channels. Among its customers are distributors, OEM aftermarket customers, technical wholesalers and hardware stores. In the DS business area, NORMA Group benefits not only from its extensive geographic presence and global manufacturing, distribution and sales capacities, but also from its well-known brands, its customized packaging and the high availability of its products at the point of sale. NORMA Group markets its joining technology products under its well-known brand names:



INTRODUCTION

OUR VISION

TO OUR SHAREHOLDERS

CONSOLIDATED
MANAGEMENT REPORT

CONSOLIDATED
FINANCIAL STATEMENTS

FURTHER INFORMATION

02 NORMA Group

03 Table of Contents

04 Two Strong
Distribution Channels

05 Financial Figures 2018

FINANCIAL FIGURES 2018

T 001		2018	2017	change in %
Order situation				
Order book (Dec 31)	EUR millions	379.2	329.1	15.2
Income statement				
Revenue	EUR millions	1,084.10	1,017.10	6.6
Adjusted gross profit ¹	EUR millions	626.6	601.3	4.2
Adjusted EBITA ¹	EUR millions	173.2	174.5	-0.8
Adjusted EBITA margin ¹	%	16.0	17.2	n/a
EBITA	EUR millions	164.8	166.8	-1.2
EBITA margin	EUR millions	15.2	16.4	n/a
Adjusted profit for the period ¹	EUR millions	114.8	105.0	9.3
Adjusted earnings per share ¹	EUR	3.61	3.29	9.6
Profit for the period	EUR millions	91.8	119.8	-23.4
Earnings per share	EUR	2.88	3.76	-23.4
NORMA Value Added (NOVA)	EUR millions	60.8	54.8	10.9
Return on Capital Employed (ROCE)	%	17.5	18.9	n/a
Cash flow				
Cash flow from operating activities	EUR millions	130.8	146.0	-10.4
Net operating cash flow	EUR millions	124.4	132.9	-6.4
Cash flow from investing activities	EUR millions	-129.5	-70.8	83.0
Cash flow from financing activities	EUR millions	31.3	-77.7	n/a
Balance sheet				
Total assets	EUR millions	1,471.7	1,312.00	12.2
Equity	EUR millions	602.4	534.3	12.7
Equity ratio	%	40.9	40.7	n/a
Net debt	EUR millions	400.3	344.9	16.1
Employees				
Core workforce		6,901	6,115	12.9
Share data				
IPO		April 2011		
Stock exchange & Market segment		Frankfurt Stock Exchange, Regulated Market (Prime Standard), MDAX		
ISIN		DE000A1H8BV3		
Security identification number/Ticker symbol		A1H8BV/NOEJ		
Highest price/Lowest price 2018 ²	EUR	70.15/40.44		
Year-end share price as of Dec 31, 2018 ²	EUR	43.18		
Market capitalization as of Dec 31, 2018 ²	EUR millions	1,376		
Number of shares		31,862,400		

¹ The adjustments are described in the Notes to the Consolidated Financial Statements. ► **NOTES, P. 141**

² Xetra price



06 Our Vision

07 Targets – Results –
Outlook

08 Quality

33 Reliability

102 Performance

OUR VISION G 001

MARKET LEADER IN CONNECTING AND FLUID HANDLING TECHNOLOGY FOR EXISTING AND FUTURE MARKETS

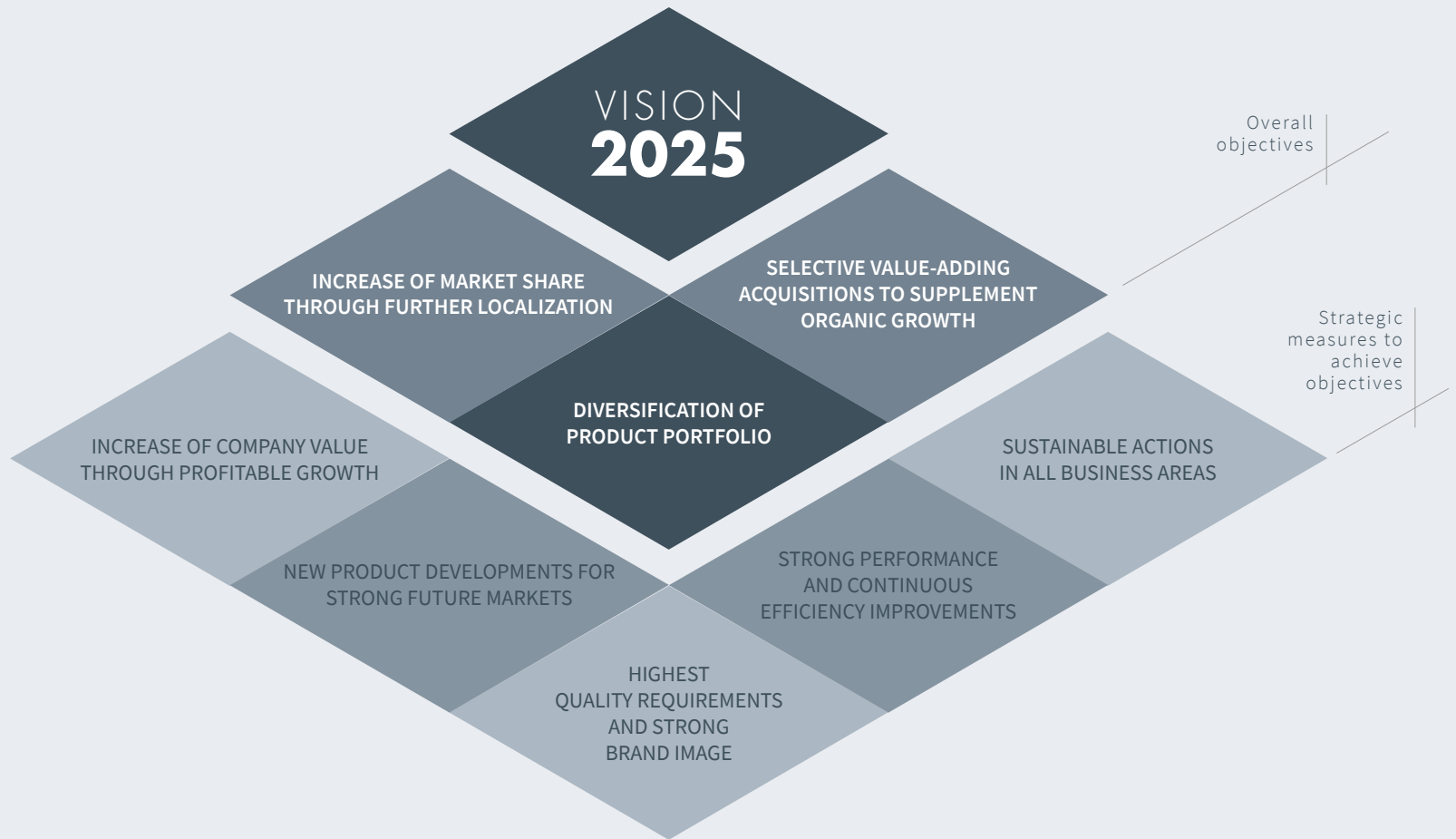

CLIMATE CHANGE AND SCARCITY OF RESOURCES
ARE GLOBAL MEGATRENDS WHICH FORM THE BASIS FOR
NORMA GROUP'S BUSINESS MODEL

TARGETS – RESULTS – OUTLOOK T 002

TARGETS 2018

Organic sales growth
**solid organic growth of around 5% to 8%,
additionally around EUR 17 million from acquisitions²**

Adjusted EBITA margin
between 16% and 17%³

NORMA Value Added
n/a⁴

Financial results
up to EUR – 15.0 million

Adjusted earnings per share
strong increase

Net operating cash flow
around EUR 130 million³

Dividend
**approx. 30% to 35% of adjusted
net profit for the period**

Number of invention applications per year
more than 20

Parts per million (PPM)⁶
below 20

Number of quality-related complaints per month
below 8

RESULTS 2018

**7.7% organic growth,
additionally EUR 16.5 million from acquisitions**

16.0%

EUR 60.8 million

EUR – 11.7 million

EUR 3.61

EUR 124.4 million

**EUR 1.10 resp. 30.5% of adjusted
net profit for the period⁵**

32

7

7

OUTLOOK 2019¹

Organic sales growth
**moderate organic growth of around 1% to 3%,
additionally around EUR 13 million from acquisitions**

Adjusted EBITA margin
between 15% and 17%

NORMA Value Added (NOVA)
between EUR 50 million and EUR 60 million

Financial result
up to EUR – 15.0 million

Adjusted earnings per share
moderate increase

Net operating cash flow
around EUR 100 million

Dividend
**approx. 30% to 35% of adjusted
net profit for the period**

Number of invention applications per year
more than 20

Parts per million (PPM)
below 20

Number of quality-related complaints per month
below 8

1_ The definition and the underlying assumptions for the calculation of the KPIs listed in the table are explained in the Management Report. ► **CONTROL SYSTEM AND CONTROL PARAMETERS, P. 45**
Changes in key figures resulting from the first-time application of IFRS 16 are not taken into account in the forecast.

2_ The forecast for the organic growth published in the **2017 ANNUAL REPORT** was increased in May 2018 (new forecast: around 5% to 8%).

3_ The forecast for the adjusted EBITA margin and the net operating cash flow published in the **2017 ANNUAL REPORT** was decreased in July 2018 (new forecast: adjusted EBITA margin between 16% and 17%, net operating cash flow of around EUR 130 million).

4_ NORMA Value Added (NOVA) was introduced to the control system for NORMA Group in fiscal year 2018.

5_ In accordance with the resolution on profit appropriation, subject to the approval of the Annual General Meeting on May 21, 2019.

6_ Parts per million: number of defective parts returned by the customer per million produced parts.

1 __ Turn for turn. The clamp resists strong tension. It owes its tensile strength to its careful construction and high-quality workmanship.



2 __ Heat, cold, fluctuating tensions. The clamp remains a reliable component even under severe pressure.

3 __ Difficult tasks, light weight. First-class materials are the basis for our ultra-light, extremely robust products.

QUALITY

QUALITY FROM THE START

A system is always only as good as its weakest link. That's why the quality of our products is so important to our customers. We prefer to set the standards because the best materials, innovative design and perfect manufacturing are essential, especially when it comes to function-critical parts.

QUALITY OUT OF RESPONSIBILITY

In 2018, our plant in the Czech Republic was presented with the Volvo Cars Quality Excellence (VQE) Award and the PSA Opel Group recognized our product quality with the prize Best Business Partner in 2018. We are very pleased to have received these awards. After all, they show that the continuous optimization of our process quality pays off.

Quality is a fundamental principle for NORMA Group that forms the basis of all its processes. Not only development and production, but also purchasing and customer service are put to the test every day. This is how we meet our responsibility as a manufacturer of function-critical parts for such demanding customers as the automotive industry, for example.



Carmela Méndez Osorio
Quality Manager at
NORMA Group in Juarez

COMPREHENSIVELY HIGH STANDARDS

QUALITY IN ALL AREAS

Purchasing

The quality of the goods is checked by a multi-disciplinary team before a purchase is made and the supplier also has to be able to guarantee his reliability and adherence to our rules in a multi-stage procedure.

Production

We can optimally monitor the quality of our production thanks to our high degree of vertical integration. By using systematic analyses, we continuously improve the processes at our plants and eliminate sources of error.

Research and development

NORMA engineering stands for the highest quality worldwide. This is our standard and our motivation. We develop our products by giving special attention to precision and long-term resilience and subject our products to the respective tests.

WATER IS THE FUTURE

In light of global warming and rising population figures, water management is an important future market. Piping and joining technology plays an important role in efficiently transporting the



Volvo Cars Quality Excellence (VQE) Award
The Czech team from
NORMA Group received the
Quality Award

Dr. Friedrich Klein
Chief Operating Officer



**TWO QUESTIONS TO
DR. FRIEDRICH KLEIN**

Chief Operating Officer (COO) of
NORMA Group SE since October 2018

Dr. Klein, you have many years of experience in the automotive industry and have been responsible for the operating business at NORMA Group since October 2018. This also includes production and quality management. How do you rate the processes at NORMA Group?

First of all, I am pleased to be able to take on this responsibility. After such a short time with the Company, I can only share my first impression, of course. But it is that the impressive development of NORMA Group is largely due to the excellent quality of our products. Fit and forget – this motto ensures customer satisfaction. And fortunately, this already determines the actions of all those involved today.

Where would you like to set accents in the further development of NORMA Group in the future?

We will serve our customers even better in the future by offering more modules and worldwide programs. For this reason, we will be increasingly aligning NORMA Group's systems across products and regions.

At the same time, we are systematically, rapidly and sustainably developing our strong regional organization even further by using best practice approaches based on stable standards and processes in the Operations division.

precious resource water to where it is needed – without wasting it. NORMA Group expanded its activities in the area of water management by acquiring the West Indian company Kimplas Piping Systems Ltd. in July 2018. The company has more than 600 employees and provides certified products for drinking water treatment, drinking water and gas supply for households and water-saving micro irrigation systems for agriculture.

Here, too, the highest quality standards apply. Especially in the field of drinking water treatment, the quality and reliability of the products play a decisive role. Therefore, Kimplas of course meets all of the customary international standards. Along with many other topics, ensuring excellent quality is one of the most important criteria for NORMA Group in the due diligence process of potential new acquisition targets.

QUALITY IN NUMBERS

The key figure PPM (parts per million) is the magic formula for product quality. It stands for the number of defective parts per million. In its Corporate Responsibility Roadmap 2020, NORMA Group has set itself the goal of achieving a sustainable number of under 20.

We also achieved this goal in fiscal year 2018 at seven PPM. We were also able to reduce the number of quality-related complaints from customers to seven in 2018.

CERTIFICATIONS

All of our plants worldwide are certified according to the quality management standards ISO 9001 or IATF 16949. Sites that are producing for the aerospace industry fulfill the respective standard EN 9100. After new acquisitions, the quality standards are harmonized within twelve months and the plants are accredited.

INTRODUCTION

OUR VISION

TO OUR SHAREHOLDERS

CONSOLIDATED
MANAGEMENT REPORT

CONSOLIDATED
FINANCIAL STATEMENTS

FURTHER INFORMATION

TO OUR SHAREHOLDERS

12 The Management Board

13 Letter from the
Management Board

15 NORMA Group on
the Capital Market

20 Supervisory
Board Report

25 Corporate
Governance
Report

THE MANAGEMENT BOARD
LETTER FROM THE MANAGEMENT BOARD
NORMA GROUP ON THE CAPITAL MARKET
SUPERVISORY BOARD REPORT
CORPORATE GOVERNANCE REPORT



INTRODUCTION

OUR VISION

TO OUR SHAREHOLDERS

CONSOLIDATED
MANAGEMENT REPORT

CONSOLIDATED
FINANCIAL STATEMENTS

FURTHER INFORMATION

TO OUR SHAREHOLDERS

THE MANAGEMENT BOARD

12 The Management Board

13 Letter from the
Management Board

15 NORMA Group on
the Capital Market

20 Supervisory
Board Report

25 Corporate
Governance
Report



DR. FRIEDRICH KLEIN
Chief Operating Officer (COO)

BERND KLEINHENS
Chief Executive Officer (CEO)

DR. MICHAEL SCHNEIDER
Chief Financial Officer (CFO)

12 The Management Board

**13 Letter from the
Management Board**15 NORMA Group on
the Capital Market20 Supervisory
Board Report25 Corporate
Governance
Report

LETTER FROM THE MANAGEMENT BOARD

Dear shareholders, customers and business partners,

'Quality, reliability and performance' – these are the maxims that we use to align our business activities, with success. 2018 was another good year for NORMA Group. Despite a challenging environment characterized by the intensifying Brexit negotiations, protectionist measures by the US government and turbulence on the international commodity markets, we were able to increase our Group sales by 6.6% to EUR 1,084.1 million. At 7.7%, organic growth was at a very high level for the second year in succession and once again shows that demand for our joining solutions remains high.

In addition to this organic growth, Kimplas and Statek, the companies acquired last year, also contributed to the increase in sales. By acquiring the Indian water company Kimplas, we expressed our strategic focus on water management and at the same time increased our presence in one of the world's most important emerging markets. Through the acquisition of Statek, a long-standing supplier to NORMA Group, we have been able to expand our value chain and also increase our flexibility in key product areas.

The high volatility on the commodity markets presented us with a number of challenges in fiscal year 2018. Price premiums of up to 60% in the area of alloy surcharges, production stoppages by suppliers and the resulting shortage of important plastic components, as well as US punitive tariffs on steel – this combination and accumulation of incidents led to an increase in costs on the materials side and to special costs in the areas of purchasing, production and logistics. We were only able to partially offset these costs with the help of our Group-wide Global Excellence Program, which is why operating earnings (adjusted EBITA) declined by 0.8% to EUR 173.2 million and the adjusted EBITA margin of 16 percent was below the usual high level of over 17%. Nevertheless, we increased our adjusted result for the period by 9.3% to EUR 114.8 million, which corresponds to adjusted earnings per share of EUR 3.61.

NORMA Group can now look back on a decade of strong growth, with an average increase in sales of around 10% (CAGR) and an increase in the number of employees from just under 3,000 in 2009 to almost 9,000 in fiscal year 2018. Since our IPO in 2011 alone, we have made 14 acquisitions and opened numerous new plants. We have entered new markets, expanded our customer base and our international presence. Against this backdrop and in order to pave the way

for the realization of our Vision 2025, we initiated a comprehensive rightsizing program in the fourth quarter of 2018. This is intended to optimize the rapidly growing production landscape and organizational structures as well as further harmonize our processes and systems worldwide. The program is also intended to help our business model prepare even better for the requirements of our strategic growth areas, electromobility and water management.

With the personnel changes in the Management Board since the beginning of 2018 and the appointment of Dr. Friedrich Klein as Chief Operating Officer (COO) in October, the NORMA Group Management Board is now complete.

Our strategy and Vision 2025 continue to focus on profitable growth and the expansion of our market and technology leadership in joining and fluid handling technology. A particular focus is on the development of product and system solutions for electromobility, especially in the area of thermal management. The main focus here is on the temperature regulation of batteries in hybrid and electric vehicles so that they maintain their optimal performance. We already have numerous solutions available for this purpose, most of which we manufacture with the current technical equipment and machines.

Besides electromobility, the focus is also on activities in the area of water management. Here, too, the goal is to meet the demand for reliable joining products and thus enable our customers to make sustainable use of this valuable resource.

With our product portfolio and our strategic orientation, we address global challenges such as climate change and scarcity of resources and focus on the sustainability of our products. We report in detail on our sustainability strategy, which we set out in our CR Roadmap 2020, in our Sustainability Report, which was published at the same time as this Annual Report.

Dear shareholders, 2018 was a turbulent year for the stock markets, and the NORMA Group share also experienced its highs and lows. After initially reaching an all-time high of more than EUR 70 in the middle of the year, the share price had to contend with some significant setbacks over the course of the second half of the year in the generally gloomy mood prevailing on the capital markets.



12 The Management Board

**13 Letter from the
Management Board**

15 NORMA Group on
the Capital Market

20 Supervisory
Board Report

25 Corporate
Governance
Report

At the end of the year, it was quoted at EUR 43.18. Therefore, the stock market year was not the best for NORMA Group. However, we are confident that the measures we have initiated and the consistent pursuit of our strategic goals will enable us to increase the value of your Company again in the current year. We are working very hard to achieve this.

We will propose a dividend of EUR 1.10 per share at this year's Annual General Meeting in Frankfurt on May 21, 2019. This means we are increasing the dividend for the seventh year in a row and distributing 30.5% of our adjusted net profit for the period to our shareholders.

Finally, we would like to express our sincere thanks to our nearly 9,000 employees worldwide for their tireless commitment and their contribution to the success of our Company. Our thanks also go to our loyal customers and business partners. We look forward to continuing our good cooperation and to a successful year 2019.

Sincerely yours,

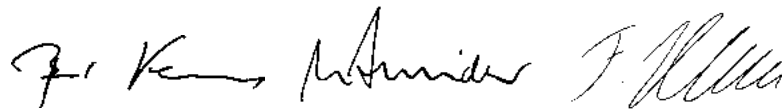

Bernd Kleinhens
Chief Executive Officer
(CEO)

Dr. Michael Schneider
Chief Financial Officer
(CFO)

Dr. Friedrich Klein
Chief Operating Officer
(COO)

12 The Management Board

13 Letter from the
Management Board**15 NORMA Group on
the Capital Market**20 Supervisory
Board Report25 Corporate
Governance
Report

NORMA GROUP ON THE CAPITAL MARKET

- ▶ Dividend of EUR 1.05 resolved at the Annual General Meeting
- ▶ 2017 Annual Report and Investor Relations work receive award again

WEAK STOCK MARKET YEAR 2018 WORLDWIDE

The stock market year 2018 caused disappointment among investors worldwide. Concerns regarding a slowdown in the global economy, the trade dispute between the US and China and the Brexit, which is approaching in March 2019, have weighed heavy on stock markets worldwide and caused high losses at the end of the year. Germany's leading index, the DAX, closed the year at 10,559 points, down 18.3%. Thus, it recorded a negative performance for the first time since 2011. The MDAX also closed the year with a significant minus of 17.6%. A similar trend could also be observed on the US stock markets. The Dow Jones, the leading US index, ended the stock market year down 5.6%, the NASDAQ Composite technology index closed at -3.9%. The 2018 stock market year in the US was thus the weakest since the 2008 financial crisis. The MSCI World Index, which is regarded as a trend indicator for the global market, also showed no better results with an annual performance of -10.4%.

PERFORMANCE OF THE NORMA GROUP SHARE

The stock market year 2018 also ended with price losses for the NORMA Group share. While the share initially showed a positive trend in the first half of the year and even reached its historic high of EUR 70.15 in mid-June, the trend reversed in the second half of the year. In the context of the generally tense situation on the capital markets and the increasingly gloomy environment for German automotive stocks, in the second half of 2018, the NORMA Group share recorded partly sharp price fluctuations and closed at EUR 43.18 at the end of the year. This equates to a decrease of 22.9% compared with the closing price at the end of 2017.

Market capitalization amounted to EUR 1.38 billion on December 31, 2018. (2017: EUR 1.78 billion). This is based on an unchanged number of 31,862,400 shares compared to the previous year. Measured by the market capitalization of the free float relevant for determining the index membership, which has been at 100% since 2013, the NORMA Group share ranked 54th out of 60 shares in the MDAX in December 2018 (Dec 2017: 42nd out of 50).

G 002 INDEX-BASED COMPARISON OF NORMA GROUP'S SHARE PRICE PERFORMANCE IN 2018 WITH THE MDAX AND DAX

IN %

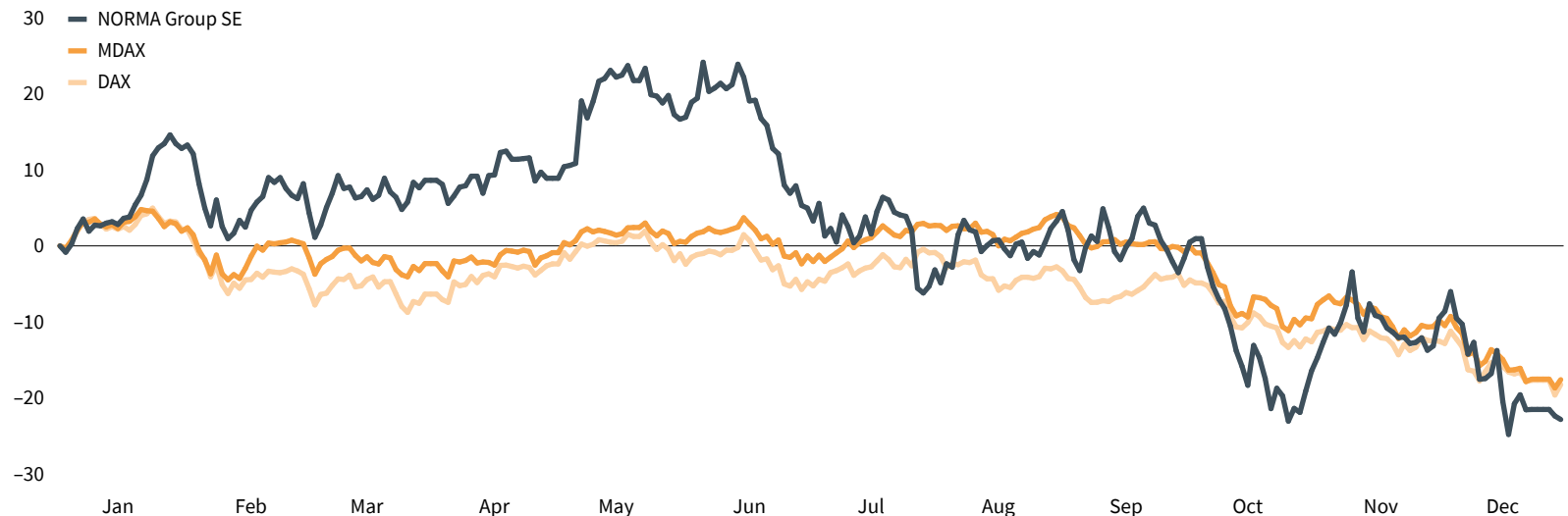

- 12 The Management Board
- 13 Letter from the Management Board
- 15 NORMA Group on the Capital Market**
- 20 Supervisory Board Report
- 25 Corporate Governance Report

TRADING VOLUME INCREASED

The average Xetra trading volume of the NORMA Group share remained almost constant in 2018 compared to the previous year and amounted to an average of 95,624 shares per day (2017: 96,906 shares). In December 2018, the NORMA Group share thus ranked 59th out of 60 in terms of trading volume (2017: 48th of 50) in the MDAX. In terms of value, this is equivalent to an increased average trading turnover of EUR 5.4 million per day compared to the previous year (2017: EUR 4.7 million).

The total average number of shares traded per day in 2018 was 268,862 (2017: 235,939). Trading was distributed among the various trading venues as follows:

G 003 DISTRIBUTION OF TRADING ACTIVITY IN 2018

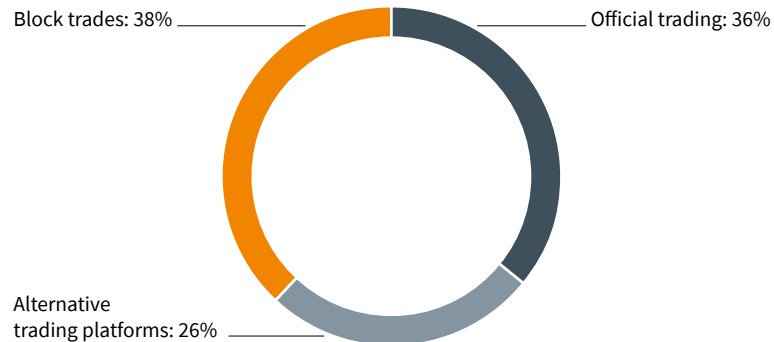

Compared to the previous year, the proportion of shares traded on the official market fell from 40% to 36%. Furthermore, the share of trading activity on alternative platforms fell slightly from 28% to 26%. By contrast, the percentage of shares traded via block trades increased to 38% compared to the previous year (2017: 32%).

BROADLY DIVERSIFIED SHAREHOLDER STRUCTURE

The NORMA Group share has gained greater international recognition in recent years due to active Investor Relations work. As a result, foreign investors have become increasingly important. Today, NORMA Group has a regionally highly diversified shareholder base with a high share of international investors mainly from the US, the UK, France, Germany and Scandinavia.

G 004 FREE FLOAT BY REGION

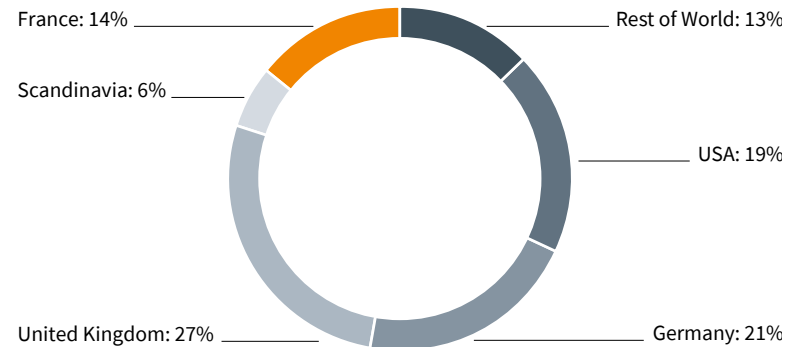

as of December 31, 2018

At the end of the reporting year, 0.6% of NORMA Group shares were held by the Management (2017: 2.3%), 3.7% (2017: 2.0%) by private investors and the remaining shares were held by institutional investors. The number of private investors (excluding management) increased from 3,356 to 3,671 in the course of fiscal year 2018.

VOTING RIGHTS NOTIFICATIONS IN 2018

Based on the voting rights notifications received by the end of 2018, shares of NORMA Group designated as free floating and amounting to over 3% are held by the following institutional investors:

T 003 OVERVIEW OF THE VOTING RIGHTS NOTIFICATIONS

IN %	
10.001	Allianz Global Investors GmbH, Frankfurt/Main, Germany
5.57	Ameriprise Financial Inc., Wilmington, DE, USA
4.98	AXA S.A., Paris, France
3.31	Impax Asset Management Group Plc, London, UK
3.05	BNP Paribas Asset Management S.A., Paris, France
3.05	The Capital Group Companies, Inc., Los Angeles, CA, USA
3.04	Allianz SE, Munich, Germany

As of December 31, 2018. Please refer to the ► **APPENDIX TO THE NOTES ON PAGE 197** for further information on the voting rights notifications received. All voting rights notifications are published on the Company's website. www.investors.normagroup.com

- 12 The Management Board
- 13 Letter from the Management Board
- 15 NORMA Group on the Capital Market**
- 20 Supervisory Board Report
- 25 Corporate Governance Report

2018 ANNUAL GENERAL MEETING

The Ordinary Annual General Meeting of NORMA Group SE was held on the premises of the German National Library in Frankfurt/Main on May 17, 2018. 24,997,984 of the 31,862,400 shares with voting rights, i.e. 78.46% of the share capital was represented. The participating shareholders resolved a dividend of EUR 1.05 per share. This corresponded to a distribution rate of 31.9% based on NORMA Group's adjusted net profit for fiscal year 2017 of EUR 105.0 million and was therefore within the scope of the dividend strategy with an annual distribution rate of approximately 30% to 35% of adjusted net profit. With the exception of the reelection of the Chairman of the Supervisory Board Dr. Stefan Wolf, all other items on the agenda were approved by clear majorities. The voting results are available on the website www.investors.normagroup.com/AGM.

DIRECTORS' DEALINGS

In fiscal year 2018, one transaction was reported as Directors' Dealings. It can be found in the Corporate Governance Report. ► **CORPORATE GOVERNANCE REPORT, P. 32**

ANALYSTS COVERING NORMA GROUP

18 analysts from various banks and research firms currently follow NORMA Group. As of December 31, 2018, nine analysts recommended buying the share, seven advised to hold the share and two recommended selling the share. The average price target was EUR 54.71 (2017: EUR 57.83).

T 004 ANALYSTS COVERING NORMA GROUP

Baader Bank	Peter Rothenaicher
Bankhaus Lampe	Christian Ludwig
Bankhaus Metzler	Jürgen Pieper
Bank of America Merrill Lynch	Kai Müller
Berenberg Bank	Philippe Lorrain
Commerzbank AG	Ingo-Martin Schachel
Deutsche Bank AG	Tim Rokossa
DZ Bank AG	Thorsten Reigber
Pareto Bank ASA (prev. Equinet)	Tim Schuldt
Hauck & Aufhäuser	Christian Glowa
HSBC	Jörg-André Finke
Jefferies	Omid Vaziri
Kepler Cheuvreux	Dr. Hans-Joachim Heimbürger
MainFirst Bank AG	Tobias Fahrenholz
NordLB	Frank Schwöpe
Quirin Privatbank	Daniel Kukulj
Société Générale	Sebastian Ubert
Warburg Research GmbH	Franz Schall

G 005 ANALYST RECOMMENDATIONS

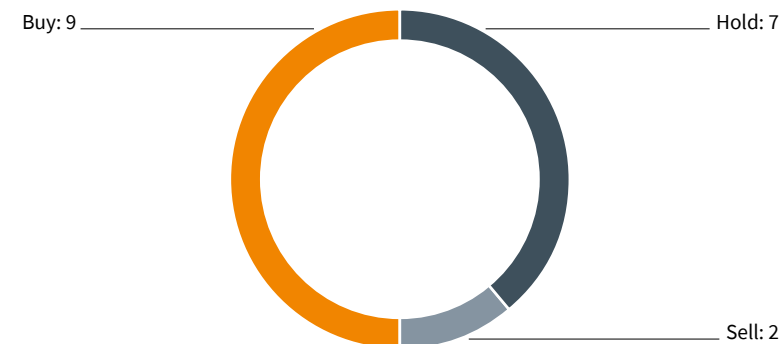

as of December 31, 2018

12 The Management Board

13 Letter from the
Management Board

**15 NORMA Group on
the Capital Market**

20 Supervisory
Board Report

25 Corporate
Governance
Report

SUSTAINABLE INVESTOR RELATIONS ACTIVITIES

NORMA Group's Investor Relations activities seek to further increase awareness of the Company on the capital market, strengthen long-term confidence in its share and achieve a realistic and fair valuation. Therefore, the management and those responsible for Investor Relations hold many discussions with institutional investors, financial analysts and private shareholders over the course of the year.

The Management Board and the Investor Relations team of NORMA Group conducted 32 roadshows in the world's most important financial centers in 2018. Furthermore, NORMA Group attended the following conferences:

- ▶ Commerzbank German Investment Seminar, New York
- ▶ German Corporate Day, Toronto & Montreal
- ▶ Kepler Cheuvreux German Corporate Conference, Frankfurt/Main
- ▶ Bankhaus Lampe Deutschlandkonferenz, Baden-Baden
- ▶ db Access Berlin Conference, Berlin
- ▶ Bankhaus Lampe Small Cap Conference, Frankfurt/Main
- ▶ Nice Conference, Nice
- ▶ Warburg Highlights Conference, Hamburg
- ▶ Commerzbank Sector Conference, Frankfurt/Main
- ▶ Berenberg & Goldman Sachs German Corporate Conference, Munich
- ▶ Baader Investment Conference, Munich
- ▶ Quirin RSVP – Large and Midcap Event, Paris
- ▶ DZ Bank Equity Conference, Frankfurt/Main
- ▶ LBBW German Corporate Day, London
- ▶ HSBC Zurich Conference, Zurich

SERVICE FOR SHAREHOLDERS

The Investor Relations website contains extensive information about the NORMA Group and the NORMA Group share. In addition to financial reports and presentations, which are available for download, all important financial market dates can be found there. The telephone conferences on the quarterly and annual reports are recorded and offered in audio format. Shareholders and interested parties can register for the distribution list by e-mail. The contact details of the IR team are also available on the website.  [INVESTORS.NORMAGROUP.COM](https://www.investors.normagroup.com)

NORMA GROUP RECEIVES AWARD FOR ITS IR WORK AGAIN

NORMA Group's IR activities and the 2017 Annual Report were once again honored in fiscal year 2018. In the 'Investors' Darling' competition, NORMA Group came in second place in the MDAX segment. In the overall ranking of all 160 companies assessed, NORMA Group ranked 6th.



T 005 KEY FIGURES FOR THE NORMA GROUP SHARE SINCE THE IPO IN 2011

	2018	2017	2016	2015	2014	2013	2012	2011	Apr 8, 2011 ¹
Closing price on Dec 31 (in EUR)	43.18	55.97	40.55	51.15	39.64	36.09	21.00	16.00	21.00 ²
Highest price (in EUR)	70.15	63.79	51.54	53.30	43.59	39.95	23.10	21.58	n/a
Lowest price (in EUR)	40.44	39.95	35.20	38.82	30.76	21.00	15.85	11.41	n/a
MDAX level on Dec 31	21,588.09	26,200.77	22,188.94	20,774.62	16,934.85	16,574.45	11,914.37	8,897.81	10,539.60
Number of unweighted shares as of Dec 31	31,862,400	31,862,400	31,862,400	31,862,400	31,862,400	31,862,400	31,862,400	31,862,400	31,862,400
Market capitalization (in EUR millions)	1,376	1,783	1,292	1,630	1,263	1,150	669	510	669
Average daily Xetra volume									
Shares	95,624	96,906	73,571	88,888	73,932	86,570	54,432	46,393	n/a
EUR millions	5.38	4.74	3.20	4.10	2.80	2.53	1.04	1.45	n/a
Earnings per share (in EUR)	2.88	3.76	2.38	2.31	1.72	1.74	1.78	1.19	n/a
Adjusted earnings per share (in EUR)	3.61	3.29	2.96	2.78	2.24	1.95	1.94	1.92	n/a
Dividend per share (in EUR)	1.10 ³	1.05	0.95	0.90	0.75	0.70	0.65	0.60	n/a
Dividend yield (in %)	2.5	1.9	2.3	1.8	1.9	1.9	3.1	3.8	n/a
Distribution rate (in %)	30.5 ³	31.9	32.0	32.3	33.4	35.9	33.5	33.2	n/a
Price-earnings ratio	15.0 ⁴	14.9	17.0	22.1	23.0	20.7	11.8	13.4	n/a
Selected indices	MDAX, CDAX, Classic All Share, Prime All Share, DAX International 100, DAXsector Industrial, DAXsector Products & Services, HDAX, MIDCAP MKT PR, STXE TM Automobiles & Parts Index, STXE TM Small Index, STXE Total Market Index								

1_ IPO and first trading day of the NORMA Group share.

2_ Issuing price.

3_ In accordance with the Management Board's proposal for the appropriation of adjusted net profit, subject to approval by the Annual General Meeting on May 21, 2019.

4_ Related to the unadjusted earnings per share. The price-earnings ratio related to the adjusted earnings per share is 12.0.

G 006 SHARE PRICE DEVELOPMENT OF THE NORMA GROUP SHARE SINCE THE IPO COMPARED TO THE MDAX

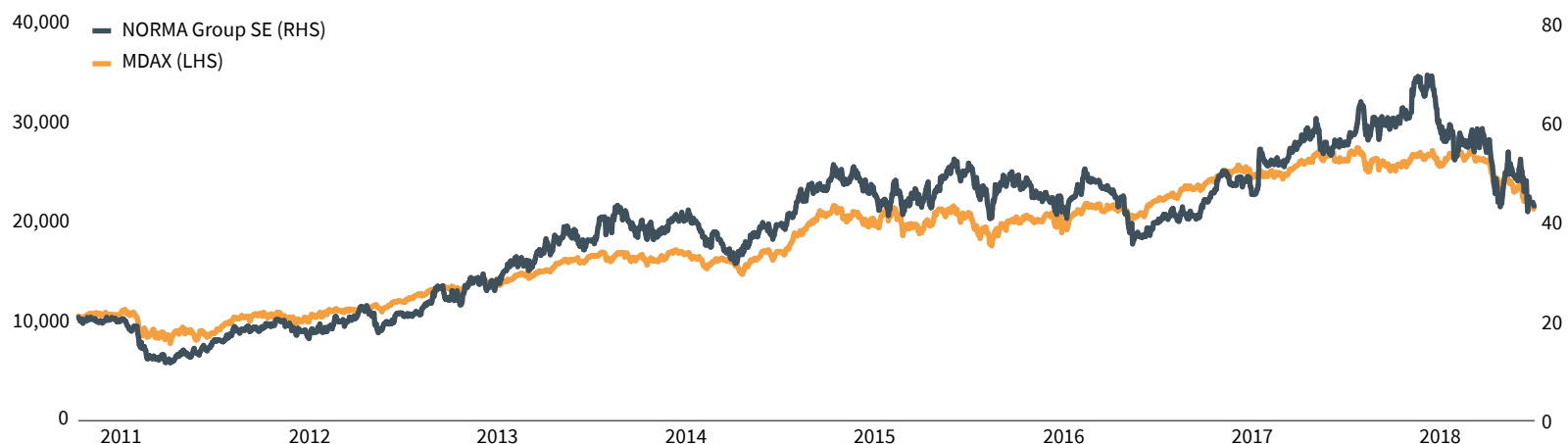

- 12 The Management Board
- 13 Letter from the Management Board
- 15 NORMA Group on the Capital Market
- 20 Supervisory Board Report**
- 25 Corporate Governance Report

SUPERVISORY BOARD REPORT

COLLABORATION BETWEEN THE SUPERVISORY BOARD AND THE MANAGEMENT BOARD

The Supervisory Board of NORMA Group SE has monitored and advised on the activities of the Management Board in fiscal year 2018 in accordance with the legal regulations, the German Corporate Governance Code and NORMA Group SE's Articles of Association.

The Management Board reports on a regular monthly basis to the Supervisory Board on the business development of NORMA Group SE and the Group and provides a forecast for the current fiscal year. The development of sales and earnings, incoming orders and the order backlog are described in detail compared to the previous year and as compared to planning. Besides monthly reporting and Supervisory Board meetings, the Chairman of the Management Board and the Chairman of the Supervisory Board engaged in regular exchanges on matters of significance in fiscal year 2018.

The Management Board begins each Supervisory Board meeting by reporting on the overall economic situation and sector-specific economic expectations, with particular attention paid to the vehicle industry and its framework conditions, such as the introduction of stricter emission standards or new measurement methods. The Management Board then reports on the respective business performance of NORMA Group and explained the earnings situation based on key indicators and their development compared to the previous year, budget and guidance. The Management Board discussed sales and the order situation for both the regions and the distribution channels EJT and DS. Accidents at work and countermeasures that have been introduced to improve work safety as well as quality and delivery and the status of the introduction of the Microsoft AX software are also regularly discussed. The Supervisory Board and Management Board also discussed NORMA Group's long-term strategic orientation, M&A projects and the integration of newly acquired companies.

At each regular meeting of the Supervisory Board and Audit Committee, the Management Board presents a detailed risk report in which the probability of occurrence and potential effects of all relevant risks, including any countermeasures, are assessed. This regular risk reporting provides the Supervisory Board and the Audit Committee with a clear picture of which possible risks could have a negative impact on the Company's assets, financial and earnings position. Moreover, compliance topics are also discussed regularly.



LARS MAGNUS BERG

Chairman of the Supervisory Board

The main topics in fiscal year 2018 were prices and the availability of production materials, stronger than expected organic growth and the development of the profit margin as well as personnel changes in the Management Board and Supervisory Board. Prices were negatively impacted by US trade policy, in particular customs duties, as well as defaults by suppliers of plastic granules who issued force majeure declarations. In light of these conditions, the Management Board presented a catalogue of measures to the Supervisory Board on July 30, 2018, that included among other measures reducing unpaid invoices, overtime and inventories.

Besides the regularly recurring topics, the Supervisory Board also dealt with the following issues in fiscal year 2018:

- 12 The Management Board
- 13 Letter from the Management Board
- 15 NORMA Group on the Capital Market
- 20 Supervisory Board Report**
- 25 Corporate Governance Report

SUPERVISORY BOARD MEETING HELD ON MARCH 19, 2018, IN MAINTAL

The Management Board and the Supervisory Board discussed the 2017 Annual Financial Statements of NORMA Group SE with the auditors and the Annual Report including the 2017 Consolidated Financial Statements of NORMA Group as well as the audit process. The Management Board and the Supervisory Board discussed the guidance for 2018. Other topics of the meeting included M&A projects such as the acquisition of Kimplas Piping Systems Ltd. in India and strategic projects for production sites.

SUPERVISORY BOARD MEETING HELD ON MAY 17, 2018, IN FRANKFURT/MAIN

Following the 2018 Annual General Meeting, which had taken place on the same day and at which five of the six proposed members of the Supervisory Board were re-elected or newly elected, but at which the previous Chairman of the Supervisory Board, Dr. Stefan Wolf, was not re-elected, the Supervisory Board decided at a constituent meeting first on the replacement of the offices and elected a new Chairman of the Supervisory Board and his deputy as well as the members and Chairmen of the Audit Committee and the General and Nomination Committee. In the course of the meeting with the Management Board, the Supervisory Board and Management Board discussed, in addition to the usual topics, the course of the Annual General Meeting, preparations for the execution of the purchase agreement to acquire the Indian company Kimplas, India, and the ongoing project to acquire Statek Stanzereitechnik GmbH, Germany. The Management Board explained the plans to open a new plant in Mexico and the potential impact of US trade policy.

SUPERVISORY BOARD MEETING HELD ON SEPTEMBER 13, 2018, IN MAINTAL

In addition to the usual agenda items, the Management Board informed the Supervisory Board, among other matters, about the establishment of the new Mexican plant and the status of implementation and already discernible effects of the short-term measures to improve profitability presented to the Supervisory Board in July 2018. The Management Board reported that a DPR (German Financial Reporting Enforcement Panel) audit had been completed without any objections. Following the meeting with the Management Board, the Supervisory Board primarily discussed personnel issues internally.

SUPERVISORY BOARD MEETING HELD ON DECEMBER 4, 2018, IN MAINTAL

The Supervisory Board and Management Board discussed the budget for 2019 and the medium-term planning. The Management Board explained the assumptions and bases of the budget planning and the resulting detailed planning. On

this basis, the Supervisory Board approved the budget. In addition, it dealt with rightsizing projects for sites in the EMEA and Americas regions. The new Executive Vice President Human Resources of NORMA Group introduced herself and presented the plans in her area to the Supervisory Board. The Management Board and Supervisory Board discussed the declaration on the German Corporate Governance Code to be submitted by January 31, 2019.

In addition, the Supervisory Board met for a closed meeting on July 30, 2018, at which the measures presented by the Management Board to increase profitability and then mainly personnel issues were discussed.

Following the meetings of the Audit Committee, the chairmen of the committees reported to the other members of the Supervisory Board. Before or after the meetings with the Management Board, the Supervisory Board met internally without the Management Board.

The Supervisory Board as a whole met on May 28, 2018, June 29, 2018, July 17, 2018, and August 14, 2018, to discuss personnel matters and exchanged information in telephone conferences and by e-mail. The General and Nomination Committee met on June 5, 2018, and July 30, 2018, or coordinated their meetings in telephone conferences and on June 28, 2018, by e-mail and on July 5, 2018, in separate telephone calls.

MAIN TOPICS OF THE AUDIT COMMITTEE IN 2018

The Audit Committee of NORMA Group convened three times in 2018. It also held four additional telephone conferences. CFO Dr. Michael Schneider took part in every meeting and telephone conference. Other participants included departmental managers of the second management level to advise on technical issues in their areas of responsibility, particularly Accounting & Reporting, Treasury, Compliance and Internal Auditing.

The Audit Committee discussed the main focuses, procedure and results of the audit of the individual and Consolidated Financial Statements of NORMA Group SE with the auditors and prepared recommendations for the Supervisory Board's resolutions.

One focus of the work of the Audit Committee in 2018 was again on NORMA Group 'Good Practice Controls.' These rules are part of the internal control system that were bindingly introduced at all NORMA Group sites in 2015. The Audit Committee also discussed the quarterly reporting with the CFO.

- 12 The Management Board
- 13 Letter from the Management Board
- 15 NORMA Group on the Capital Market
- 20 Supervisory Board Report**
- 25 Corporate Governance Report

At the beginning of each meeting, the Audit Committee was informed in detail about the current business situation and financial position of NORMA Group. The Audit Committee monitored the effectiveness of the internal control system, the risk management system, the internal auditing system and the compliance management system. The Audit Committee approved the audit plan for internal revision for 2018. Other topics discussed by the Audit Committee included budget planning for 2019, medium-term planning and a DPR (German Financial Reporting Enforcement Panel) audit. The Audit Committee also discussed treasury matters, the introduction of Microsoft AX software, the integration of Kimplas and Statek, the companies acquired in 2018, the status of digitalization within NORMA Group and the effects of the General Data Protection Regulation.

The Audit Committee also approved certain individual allowable non-audit services that may be provided by the statutory auditors at PwC.

Outside of the Audit Committee meetings, the Chairman of the Audit Committee was in regular personal and telephone contact with the CFO and the auditors to discuss possible areas of emphasis for the audit of the 2018 Annual Financial Statements as well as the focus of the work of the Audit Committee in the fiscal year 2019.

ACTIVITIES OF THE GENERAL AND NOMINATION COMMITTEE

The General and Nomination Committee met four times, held telephone conferences, made individual phone calls and exchanged e-mails. Among other topics, it discussed Management Board contracts and proposed candidates for the Supervisory Board mandate to be filled and the open Management Board position of Chief Operating Officer (COO).

CHANGES IN THE SUPERVISORY BOARD AND ITS COMMITTEES

The terms of office of all members of the Supervisory Board ended with the Annual General Meeting on May 17, 2018. Dr. Christoph Schug, who had been a member of the Supervisory Board of NORMA Group AG and NORMA Group SE without interruption since 2011, did not stand for re-election at the 2018 Annual General Meeting. Lars Berg, Günter Hauptmann, Dr. Knut Michelberger and Erika Schulte were re-elected and Rita Forst was elected to the Supervisory Board for the first time. Dr. Stefan Wolf, who had served as Chairman of the Supervisory Board of NORMA Group AG and NORMA Group SE since 2011, was not re-elected. Therefore, the Supervisory Board temporarily consisted of only five instead of six

members until Mark Wilhelms was appointed a member of the Supervisory Board by court order on August 29, 2018.

At its constituent meeting on May 17, 2018, the Supervisory Board elected Lars Berg as its Chairman and Erika Schulte as its Vice-Chairwoman. Dr. Knut Michelberger (Chairman), Erika Schulte and Rita Forst were confirmed or newly elected as members of the Audit Committee and Lars Berg (Chairman), Günter Hauptmann and Dr. Knut Michelberger as members of the General and Nomination Committee.

CHANGE ON THE MANAGEMENT BOARD

On November 30, 2017, the Supervisory Board had already decided to extend the term of office of Bernd Kleinhens until the end of December 31, 2022, and to appoint him Chairman of the Management Board of NORMA Group with effect from January 1, 2018. In addition, the decision was made to extend the term of office of CFO Dr. Michael Schneider until the end of June 30, 2023. The contracts of the two members of the Management Board were also amended. The Supervisory Board had noted with approval that Werner Deggim, the previous CEO, was resigning from his positions within NORMA Group with effect from the end of December 31, 2017, and would be released from his duties as of January 1, 2018, and that his contract of service on the Management Board would otherwise remain unaffected.

The Supervisory Board had also agreed that John Stephenson, the former Chief Operating Officer (COO), would resign from his positions within NORMA Group with effect from January 31, 2018, and that a corresponding termination agreement would be concluded with him. Mr. Stephenson had decided to accept a position outside of NORMA Group and not to renew his contract, which expired in 2018. The Supervisory Board was able to appoint Dr. Friedrich Klein as his successor. By resolution of September 19, 2018, the Supervisory Board appointed Dr. Klein to the Management Board of NORMA Group SE (Chief Operating Officer, COO) with effect from October 1, 2018, for a term of three years. Until his departure, John Stephenson was responsible for Production, Purchasing, Supply Chain Management, the Global Excellence Program and Quality Assurance. Bernd Kleinhens, Chairman of the Management Board, temporarily assumed responsibility for these areas. Since October 1, 2018, Dr. Friedrich Klein has taken over these areas and is also responsible for ICT.

12 The Management Board

13 Letter from the
Management Board15 NORMA Group on
the Capital Market**20 Supervisory
Board Report**25 Corporate
Governance
Report**ATTENDANCE OF ALL MEETINGS,
NO CONFLICTS OF INTEREST**

All Supervisory Board members, Lars Berg, Günter Hauptmann, Dr. Knut Michelberger and Erika Schulte as well as Dr. Stefan Wolf and Dr. Christoph Schug (until the Annual General Meeting on May 17, 2018) and the two newly elected or court-appointed members in 2018, Rita Forst (since the Annual General Meeting on May 17, 2018), Mark Wilhelms (since August 29, 2018), participated in all meetings, telephone conferences and the closed meeting in 2018, with the exception of one telephone conference for which Mrs. Forst was excused.

All Audit Committee members, Dr. Knut Michelberger (Chairman) and Erika Schulte, as well as Lars Berg (until the 2018 Annual General Meeting) and Rita Forst (since the 2018 Annual General Meeting), participated in all Audit Committee meetings. Mrs. Forst was excused from a telephone conference of the Audit Committee. The other Audit Committee members also participated in all telephone conferences.

All members of the General and Nomination Committee, Lars Berg (Chairman since the 2018 Annual General Meeting), Günter Hauptmann and Dr. Knut Michelberger (both since the 2018 Annual General Meeting) each attended all meetings of the General and Nomination Committee. No meetings of the General and Nomination Committee were held prior to the 2018 Annual General Meeting. Until then, personnel issues were prepared by the Chairman of the Supervisory Board and then discussed directly with the Supervisory Board as a whole.

There were no conflicts of interest between Supervisory Board members and the Company in fiscal year 2018. Dr. Knut Michelberger and Günter Hauptmann have been members of an advisory board of a company that competes insignificantly with NORMA Group since July 2018 and September 2016 respectively. The respective Chairman of the Supervisory Board, the two members of the Supervisory Board and the Management Boards had discussed whether conflicts of interest could arise as a result of this activity and how this should be dealt with. To date, no conflicts of interest have arisen from these positions.

INFORMATION ON THE AUDITOR

The 2018 Annual Financial Statements for NORMA Group SE presented by the Management Board along with the Management Report and the corresponding Consolidated Financial Statements and Group Management Report were audited by the auditing firm PricewaterhouseCoopers GmbH Wirtschaftsprüfungsgesellschaft. The audit mandate was issued on December 4, 2018.

The auditors Thomas Tilgner, Richard Gudd (first half year) and Benjamin Hessel (second half year) took part in the Supervisory Board meeting held to formally adopt the financial statements as well as in all Audit Committee meetings on the respective agenda items and a conference call with the Audit Committee.

**APPROVAL OF THE 2018 ANNUAL FINANCIAL
STATEMENTS AND THE SEPARATE NON-FINANCIAL
STATEMENT FOR THE GROUP**

The Consolidated Financial Statements of NORMA Group SE were prepared in accordance with Section 315e of the German Commercial Code (Handelsgesetzbuch, HGB) on the basis of International Financial Reporting Standards (IFRS) as adopted in the EU. The auditor issued an unqualified opinion for the 2018 Annual Financial Statements and Management Report of NORMA Group SE as well as for the Consolidated Financial Statements and Group Management Report. The documents pertaining to the financial statements, the Management Board's proposal for the appropriation of net profit and both auditors' reports were submitted to the Supervisory Board. The Audit Committee and the Supervisory Board in its entirety thoroughly examined the reports and discussed and scrutinized them in detail together with the auditor. The Supervisory Board accepted the auditor's findings and had no objections.

The Supervisory Board then approved the 2018 Annual Financial Statements of NORMA Group SE and the 2018 Consolidated Financial Statements together with their respective Management Reports at its meeting on March 18, 2019. The Supervisory Board approved the proposal on the appropriation of profits by the Management Board. NORMA Group SE's Annual Financial Statements are thereby adopted in accordance with Section 172 of the German law on stock corporations.

The Audit Committee and Supervisory Board also dealt with the separate Non-Financial Group Report for NORMA Group prepared by the Management Board as of December 31, 2018. The auditing firm PricewaterhouseCoopers GmbH has conducted a limited assurance test and issued an unqualified audit opinion. The Management Board explained the documents in detail during the meetings, while the representatives of the auditor reported on the main findings of their audit and answered further questions from the members of the Supervisory Board. The Supervisory Board had no objections after auditing these results.

12 The Management Board

13 Letter from the
Management Board15 NORMA Group on
the Capital Market**20 Supervisory
Board Report**25 Corporate
Governance
Report**DECLARATION OF CONFORMITY WITH THE GERMAN
CORPORATE GOVERNANCE CODE**

The Supervisory Board and Management Board dealt with the requirements of the German Corporate Governance Code and ratified the following Declaration on January 31, 2019, including the exceptions stated in the Declaration of Conformity: "NORMA Group SE has complied with the recommendations of the German Corporate Governance Code as amended on February 7, 2017 (published on April 24, 2017), by the Federal Ministry of Justice in the official section of the Federal Gazette ("Bundesanzeiger") since its last Declaration was submitted and will continue to comply with the recommendations." The Corporate Governance Declarations made by NORMA Group SE are available on the Company's website at www.investors.normagroup.com.

The Supervisory Board would like to thank all employees of NORMA Group all around the world along with the Management Board for their personal efforts and successful work once again in fiscal year 2018. The Supervisory Board is confident that NORMA Group will continue to develop successfully in fiscal year 2019.

Maintal, March 18, 2019

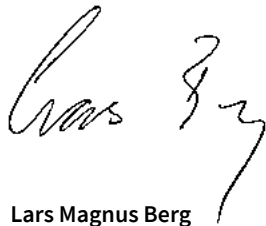
**Lars Magnus Berg**

Chairman of the Supervisory Board

12	The Management Board
13	Letter from the Management Board
15	NORMA Group on the Capital Market
20	Supervisory Board Report
25	Corporate Governance Report

CORPORATE GOVERNANCE REPORT

The following is the Management Board's Declaration of Conformity in accordance with article 289f of the German Commercial Code (Handelsgesetzbuch, HGB) and Section 3.10 of the German Corporate Governance Code (GCGC).

The management of NORMA Group is dedicated to achieving sustained economic success while complying with the Company's social responsibility. Transparency, responsibility and sustainability are the principles that determine its actions.

DECLARATION OF CONFORMITY WITH THE GERMAN CORPORATE GOVERNANCE CODE

The Supervisory Board and Management Board of NORMA Group SE have thoroughly examined which of the German Corporate Governance Code's recommendations and suggestions NORMA Group SE should follow and explains deviations from the recommendations and the reasons for deviating from the Code. The current Declaration dated January 31, 2019, as well as all the other Declarations are published on NORMA Group's website.  [INVESTORS. NORMAGROUP.COM](http://www.investors.normagroup.com)

The Declaration dated January 31, 2019, is presented below:

With the following exceptions, NORMA Group SE has complied since its last declaration was submitted, and will continue to comply, with the recommendations of the German Corporate Governance Code as amended on February 7, 2017 (published on April 24, 2017 by the Federal Ministry of Justice in the official section of the Federal Gazette) ('Bundesanzeiger'):

1. With respect to the compensation of the members of the Management Board, the Supervisory Board does not take into account the compensation of the upper management or the workforce as a whole (Section 4.2.2 para. 2 GCGC).

When determining the compensation of the Management Board, the Supervisory Board, advised by an external remuneration expert, also took into account the compensation structure of the Company as well as the entire NORMA Group. Due to NORMA Group's dynamic development, the Supervisory Board has so far not explicitly defined the upper management or the workforce as a whole and, therefore, does not take these groups or their development over time into account.

2. Under service agreements with members of the Management Board, the remuneration of the Management Board is not capped, either in total or in terms of its variable compensation elements (Section 4.2.3 para. 2 sentence 7 GCGC).

The Supervisory Board may grant in its sole discretion a special bonus for extraordinary achievements which is not limited by a maximum amount. The Supervisory Board does not believe such a maximum amount to be required because the Supervisory Board can ensure by specifically exercising its discretion that the requirement of adequacy under Section 87 para. 1 of the German law on stock corporations is complied with. Until today, the Supervisory Board has never granted such a special bonus.

Apart from that, the agreements with all current members of the Management Board that were entered into since 2015 comply with the recommendations pursuant to Section 4.2.3 para. 2 sentence 7 of the German Corporate Governance Code. In addition, the management service agreements that were entered into prior to 2015 depart from the recommendations pursuant to Section 4.2.3 para. 2 of the GCGC as follows:

The maximum gross option profit from the Matching Stock Program (MSP) for the Management Board is limited in total to a percentage of the average annual (adjusted) EBITA during the vesting period; therefore, a relative maximum limit that is dependent on the Company's success is applied rather than a maximum monetary amount.

The maximum amount of the long-term variable remuneration under the Long-Term Incentive Plan is limited to 250% of the amount that results based on the three-year average value of the (adjusted) annual EBITA or the free cash flow that the Company has budgeted multiplied by the respective bonus percentages set in the employment contract.

Under these programs, payments are still made to former members of the Management Board and Mr. Kleinhens.

3. Two members of the Supervisory Board have already reached, or will before the end of their tenure reach, the regular age limit (Section 5.4.1 para. 2 sentence 2 half sentence 4 GCGC).

The tenure of a Supervisory Board member shall not be extended beyond his or her 70th birthday. Mr. Berg and Dr. Michelberger are already older than 70. The Supervisory Board is of the opinion that there is currently no reason to prematurely end these mandates prior to the end of the tenure.



- 12 The Management Board
- 13 Letter from the Management Board
- 15 NORMA Group on the Capital Market
- 20 Supervisory Board Report
- 25 Corporate Governance Report**

Membership in the Supervisory Board should mainly depend on abilities and actual capacities.

STATEMENT ON CORPORATE GOVERNANCE

ALLOCATION OF COMPETENCES BETWEEN THE MANAGEMENT AND THE SUPERVISORY BOARD

NORMA Group SE uses a similar type of dual management system that German stock corporations use. Here, the Supervisory and Management Boards are separate bodies that have different functions and powers. The Management Board manages the Company under its own responsibility. The Supervisory Board appoints, advises, monitors and dismisses members of the Management Board.

The Management Board provides the Supervisory Board with regular updates about its business policies, how the business is developing, the position of the Company and any transactions that could have a significant impact on profitability or liquidity. The Management Board reports the key figures of the Group and the current course of business to the Supervisory Board on a monthly basis, in particular with regard to the published guidance on the expected development of the Company. Based on the written documents that were submitted to the Supervisory Board in advance, the members of the Management Board report in great detail on business developments and provide an outlook on the expected future development of NORMA Group at the Supervisory Board meetings. Other recurring topics at all meetings include the monthly and quarterly figures, risk analysis and measures aimed at minimizing any risks that had been detected, reports by the respective Committee Chairmen on the previous meetings held and strategic projects. All Management Board members participate in the Supervisory Board meetings. The Supervisory Board convenes separately before or after meeting with the Management Board.

The Chairman of the Supervisory Board and the Chairman of the Management Board coordinate the collaboration of the two Boards. They also stay in regular contact between Supervisory Board meetings and discuss current corporate governance issues.

In accordance with the legal requirements, the by-laws of the Management Board and NORMA Group's Articles of Association, the Supervisory Board must approve certain important transactions before they can be executed by the Management Board and the Company's employees. This applies not only for measures at NORMA Group SE, but also for measures at its subsidiaries. In order to ensure that the Management Board is promptly informed of corresponding matters involving subsidiaries so that it can request the approval of the Supervisory

Board, a hierarchical system of approval requirements organized by functional areas, levels of responsibility and countries applies worldwide at NORMA Group.

MANAGEMENT BOARD AND REGIONAL MANAGEMENT

The Management Board of NORMA Group SE is composed of three members: Bernd Kleinhens (Chairman), Dr. Michael Schneider (CFO) and Dr. Friedrich Klein (Chief Operating Officer).

T 006 RESPONSIBILITIES OF THE MANAGEMENT BOARD

Bernd Kleinhens, Chairman of the Management Board (CEO)	<ul style="list-style-type: none"> ▶ Personnel ▶ Group Development ▶ Group Communications ▶ Business Development including Sales, Marketing, Research & Development, Product Development, Price Development and Product Management
Dr. Michael Schneider, Chief Financial Officer (CFO)	<ul style="list-style-type: none"> ▶ Finance & Reporting ▶ Controlling ▶ Insurances ▶ Treasury ▶ Investor Relations ▶ Legal and M&A ▶ Risk Management ▶ Compliance & Internal Auditing ▶ Corporate Responsibility
Dr. Friedrich Klein, Member of the Management Board (COO)	<ul style="list-style-type: none"> ▶ Production ▶ Purchasing ▶ Supply Chain Management ▶ Operational Global Excellence ▶ Information & Communication Technology (ICT) ▶ Quality Assurance ▶ ESG (Environment, Social, Governance)

John Stephenson was the Management Board member for the Supply Chain and Operations responsible for Production, Purchasing, Supply Chain Management, Operational Global Excellence and Quality Assurance until he stepped down from the Management Board on January 31, 2018. Bernd Kleinhens, Chairman of the Management Board, was temporarily responsible for these areas. Since October 1, 2018, Dr. Friedrich Klein has taken over these areas and is also responsible for ICT.

In general, Management Board resolutions are passed by simple majority. The Chairman has the deciding vote if the vote is tied. However, the members of the Management Board are obliged to make an effort to reach unanimous decisions. If a member of the Management Board cannot participate in a vote, his vote will be obtained at a later date. The entire Management Board is responsible with

12 The Management Board

13 Letter from the
Management Board15 NORMA Group on
the Capital Market20 Supervisory
Board Report25 **Corporate
Governance
Report**

matters of particular importance. In accordance with the Management Board by-laws, these include the following matters: producing the Management Board reports for the purpose of informing the Supervisory Board and the quarterly and half-yearly reports, fundamental organizational measures, including the acquisition or disposal of significant parts of companies and strategic and business planning issues, measures related to the implementation and supervision of a monitoring system pursuant to Section 91 (2) of the German law on stock corporations, issuing the Declaration of Conformity pursuant to Section 161 (1) of the German law on stock corporations, preparing the Consolidated and Annual Financial Statements and similar reports, convening the Annual General Meeting and inquiries and recommendations by the Management Board that are to be handled and resolved by the Annual General Meeting. In addition, every Management Board member may request that a specific issue be dealt with by the entire Management Board. The Management Board did not form any committees. Board meetings are usually held at least once a month.

Every Board member is obliged to inform the Supervisory Board immediately, but also the other members of the Management Board, of any conflicts of interest. No such conflicts of interest arose for a Board member in 2018.

The Supervisory Board must approve any transactions between NORMA Group companies on the one hand and a member of the Management Board, related parties or businesses on the other hand. No such transactions took place in 2018.

The Supervisory Board must also approve any secondary activities by a member of the Management Board. It had already agreed that CFO Dr. Schneider may continue to be a member of the Supervisory Boards of two German companies. It also agreed to Mr. Stephenson, who left the Management Board at the end of January 2018, holding shares in a family-owned English company. Mr. Kleinhens and Dr. Klein do not perform any secondary activities that are subject to approval.

The rules of procedure of the Supervisory Board provide that the term of office of a member of the Management Board should not be extended beyond his or her 65th birthday. Former CEO Werner Deggim left the Management Board on December 31, 2017. This date was before his 65th birthday.

Local Presidents in the three regions EMEA, Americas and APAC are responsible for carrying out business on a daily basis. These three Presidents report directly to the Chairman of the Management Board. The entire Management Board of NORMA Group SE meets at least once a year with the Presidents and their managers at the local headquarters – Singapore for the Asia-Pacific region, Auburn Hills, Michigan, for the Americas, and Maintal for the EMEA region. In addition,

individual members of the Management Board meet regularly with the local teams. The managers at NORMA Group work in a matrix structure in which they have both a disciplinary as well as a technical supervisor.

SUPERVISORY BOARD: MEMBERS, ELECTION AND INDEPENDENCE

The Supervisory Board of NORMA Group SE is comprised of the following six members:

- ▶ Lars M. Berg (Chairman of the Supervisory Board)
- ▶ Erika Schulte (Vice Chairwoman of the Supervisory Board)
- ▶ Günter Hauptmann
- ▶ Rita Forst
- ▶ Dr. Knut J. Michelberger
- ▶ Mark Wilhelms

They are all representatives of the shareholders. NORMA Group SE is not a code-terminated Company; therefore, worker representatives are not represented on its Supervisory Board. Proceedings pursued by Dr. Konrad Erzberger concerning the composition of the Supervisory Board of NORMA Group SE ('Status Procedure') came to an end in 2018. Dr. Erzberger withdrew his appeal in July 2018 after the Regional Court of Frankfurt/Main had rejected the request as unfounded and decided not to remedy the appeal filed against it, but rather submitted it to the Higher Regional Court.

The members of the Supervisory Board are elected by the Annual General Meeting. Since fewer than six members had been elected at the 2018 Annual General Meeting and the Supervisory Board therefore temporarily had only five members, Mark Wilhelms was appointed by the court as the sixth member. The Local Court of Hanau appointed Mark Wilhelms on August 29, 2018, until his election by the Annual General Meeting or the election of another Supervisory Board member by the Annual General Meeting; this is expected to be until May 21, 2019. The appointment of the other current Supervisory Board members took place upon their election at the Annual General Meeting on May 17, 2018, and ends with the conclusion of the Annual General Meeting which resolves on the discharge of the Supervisory Board for fiscal year 2022, but for no longer than six years.

All members of the Supervisory Board are independent as defined in Section 5.4.2 of the German Corporate Governance Code. Furthermore, no Supervisory Board member has ever served as a member of the Management Board of NORMA Group SE or been a member of management of any of its predecessor companies.

12 The Management Board

13 Letter from the
Management Board

15 NORMA Group on
the Capital Market

20 Supervisory
Board Report

**25 Corporate
Governance
Report**

Three of the six members of the Supervisory Board of NORMA Group SE, Mr. Berg, Mr. Hauptmann, Dr. Michelberger, have been members of the Supervisory Board since 2011. Mrs. Schulte has been a member of the Supervisory Board since 2012. Mrs. Forst and Mr. Wilhelms have been members since 2018.

The rules of procedure of the Supervisory Board provide that the term of office of a member of the Supervisory Board should not be extended beyond his or her 70th birthday. Mr. Berg and Dr. Michelberger have already reached this age limit.

There are no consultancy, other service or work contracts between NORMA Group companies and a member of the Supervisory Board.

All members of the Supervisory Board are obligated to report any conflicts of interest. Significant and not merely temporary conflicts of interest for members of the Supervisory Board should lead to the termination of the mandate. No such conflicts of interest arose in 2018.

Four ordinary meetings of the Supervisory Board were held in fiscal year 2018. These meetings were attended by all members of the Supervisory Board and the Management Board. In July 2018, the Supervisory Board met for a closed-door meeting in which Mr. Kleinhens and Dr. Schneider temporarily participated and which otherwise took place without the Management Board. The Supervisory Board as a whole met on May 28, 2018, June 29, 2018, July 17, 2018 and August 14, 2018, to discuss personnel issues, or coordinated its meetings in telephone conferences and by e-mail. All members of the Supervisory Board took part in these meetings, with the exception of one telephone conference at which Mrs. Forst was excused. The General and Nominations Committee met on June 5, 2018 and July 30, 2018, and discussed on telephone conferences and on June 28, 2018 by e-mail and on July 5, 2018 in separate telephone calls.

The Chairman of the Supervisory Board represents the Supervisory Board externally. He organizes the work of the Supervisory Board and chairs its meetings. The Supervisory Board can pass resolutions by simple majority, whereby the Chairman has the deciding vote if a vote is tied.

The Supervisory Board has two committees: the Audit Committee and the General and Nomination Committee.

The Audit Committee deals in particular with monitoring the accounting process and the effectiveness of the internal control and risk management systems as well as the audit of the Annual Financial Statements, in particular through the independence of the auditor, the additional services rendered by the auditor, engaging the auditor, determining areas of audit emphasis and agreeing to the

auditor's fees. The Audit Committee accompanies the collaboration between NORMA Group SE and the auditors and ensures that opportunities for improvement identified during the audit are promptly implemented. It is responsible for preparing the accounting documents and adopting the Supervisory Board's resolution on the consolidated and separate financial statements. Moreover, it is responsible for compliance and reviews the compliance with statutory provisions and the internal guidelines.

Dr. Michelberger is Chairman of the Audit Committee. The other members were Lars Berg and Erika Schulte until the 2018 Annual General Meeting, Erika Schulte and Rita Forst since the Annual General Meeting. Dr. Michelberger is an independent financial expert within the meaning of Section 100 (5) AktG. Due in large part to his many years as CFO and Managing Director, he has particular knowledge and experience in the application of accounting principles and internal guidelines.

Three meetings of the Audit Committee and four telephone conferences were held in fiscal year 2018. All Audit Committee members took part in the meetings. Mrs. Forst did not take part in one of the telephone conferences while the other members took part in all of the telephone conferences.

The General and Nomination Committee prepares personnel-related decisions for the Supervisory Board. This committee has the following specific responsibilities: preparing Supervisory Board resolutions regarding the formation, amendment and termination of employment contracts with members of the Management Board in accordance with the remuneration system approved by the Supervisory Board, preparing Supervisory Board resolutions regarding legal applications to reduce the remuneration of a Management Board member pursuant to Section 87 (2) AktG, preparing Supervisory Board resolutions regarding the structure of the remuneration system for the Management Board, acting as representatives of the Company to Management Board members who have left the Company pursuant to Section 112 AktG, approving secondary employment and external activities for Management Board members pursuant to Section 88 AktG, granting loans to the persons specified in Section 89 AktG (loans to members of the Management Board) and Section 115 AktG (loans to members of the Supervisory Board), approving contracts with members of the Supervisory Board pursuant to Section 114 AktG and proposing suitable candidates to the Annual General Meeting when there is a vote on Supervisory Board members.

Until the 2018 Annual General Meeting, the members of the General and Nomination Committee were Dr. Stefan Wolf, Chairman of the Supervisory Board, as Chairman, and Dr. Christoph Schug and Lars Berg as additional members, followed by the new Chairman of the Supervisory Board, Lars Berg, Günter

12 The Management Board

13 Letter from the
Management Board15 NORMA Group on
the Capital Market20 Supervisory
Board Report**25 Corporate
Governance
Report**

Hauptmann and Dr. Knut Michelberger. The General and Nomination Committee did not meet until the 2018 Annual General Meeting. Before then, all personnel matters had been prepared by the Chairman of the Supervisory Board and discussed directly with the entire Supervisory Board. Afterwards, all members of the committee attended all meetings.

OTHER MANDATES OF THE SUPERVISORY BOARD MEMBERS

Exercised professions and other mandates on Supervisory Boards or comparable Supervisory Bodies of the members of NORMA Group's Supervisory Board in fiscal year 2018 are shown in ► **TABLE 007**.

T 007 OTHER MANDATES OF THE SUPERVISORY BOARD MEMBERS

Supervisory Board member, exercised office	Other mandates on Supervisory Boards and comparable committees
Lars M. Berg (Chairman), Consultant	<ul style="list-style-type: none"> ▶ Chairman of the Supervisory Board of Greater Than AB, Stockholm, Sweden (listed on the stock exchange) ▶ Chairman of the Supervisory Board of Net Insight AB, Stockholm, Sweden (until May 8, 2018, listed on the stock exchange)
Erika Schulte, (Vice-Chairwoman), Managing Director of Hanau Wirtschaftsförderung GmbH	<ul style="list-style-type: none"> ▶ No seats on other boards or comparable committees
Rita Forst, Consultant	<ul style="list-style-type: none"> ▶ Member of the Supervisory Board of ElringKlinger AG, Dettingen, Germany (listed on the stock exchange) ▶ Member of the Advisory Board of Joh. Winkhofer Beteiligungs GmbH & Co. KG (iwis), Munich, Germany (not listed on the stock exchange) ▶ Member of the Advisory Board of Metalsa, S.A. de C.V., Monterrey, Mexico (not listed on the stock exchange) ▶ Member of the Advisory Board of Westport Fuel Systems Inc., Vancouver, Canada (listed on the stock exchange)
Günter Hauptmann, Consultant	<ul style="list-style-type: none"> ▶ Chairman of the Advisory Board of Atesteo GmbH (formerly GIF GmbH), Alsdorf, Germany (until February 14, 2018, not listed on the stock exchange) ▶ Member of the Advisory Board of Moon TopCo GmbH (Schlemmer Group), Poing, Germany (not listed on the stock exchange)
Dr. Knut J. Michelberger, Consultant	<ul style="list-style-type: none"> ▶ Member of the Supervisory Board of Weener Plastics Group, Ede, The Netherlands (not listed on the stock exchange) ▶ Member of the Advisory Board of Kaffee Partner Holding GmbH, Osnabrück, Germany (not listed on the stock exchange) ▶ Member of the Advisory Board of Rena Technologies GmbH, Gütenbach, Germany (not listed on the stock exchange) ▶ Vice Chairman of the Advisory Board of Racing TopCo GmbH, Troisdorf, Germany (since May 2018, not listed on the stock exchange) ▶ Member of the Advisory Board of Moon TopCo GmbH (Schlemmer Group), Poing, Germany (since July 2018, not listed on the stock exchange) ▶ Member of the Advisory Board of Tegimus Holding GmbH, Mannheim, Germany (since July 2018, not listed on the stock exchange)
Mark Wilhelms, Chief Financial Officer at Stabilus S.A.	<ul style="list-style-type: none"> ▶ No seats on other boards or comparable committees



- 12 The Management Board
- 13 Letter from the Management Board
- 15 NORMA Group on the Capital Market
- 20 Supervisory Board Report
- 25 Corporate Governance Report**

TARGETS FOR THE SHARE OF WOMEN

As early as 2015, the Supervisory Board of NORMA Group SE had set targets for the Supervisory Board and Management Board of NORMA Group SE and the Management Board for the management level of NORMA Group SE below the Management Board as well as a time limit for implementing them. These targets were adjusted as follows in 2017:

The target figure for the share of women on the Supervisory Board is two female members (out of a total of six). For the Management Board, the target is zero. For the top management level of NORMA Group SE, the target figure is a 25% share of women. The aforementioned new targets are expected to apply until June 30, 2022. They were all achieved or exceeded in the fiscal year under review. Two female members have been members of the Supervisory Board since its re-election on May 17, 2018.

The Management Board currently consists exclusively of men. In accordance with the rules of procedure of the Supervisory Board, the Supervisory Board should pay attention to diversity in the composition of the Management Board. Furthermore, the Supervisory Board does not consider it in the interest of the Company to set higher targets for the proportion of women in the Management Board. For this reason, the target figure for the proportion of women on the Management Board remains zero. This target was achieved unchanged in 2018.

At NORMA Group SE, the first management level comprises all persons who are Executive Vice Presidents or Vice Presidents, report directly to the Management Board, assume management responsibilities and bear personnel responsibility. Although the proportion of women in the first management level was 50% when the resolution was passed in 2017 (as in 2015), the Management Board had set the target figure for the proportion of women in the first management level at least 25%. This neither meant a reduction in the proportion of women nor ruled out the possibility that the proportion of women would rise to over 50%. In fact, the proportion of women rose from 50% to 60% in 2018. Among the total of five persons (previously four) who now form the first management level below the Management Board, there are now three women, since the Executive Vice President Human Resources has been employed at NORMA Group SE and not, like her predecessor, at NORMA Group Holding GmbH, a subsidiary of NORMA Group SE. The target figure of 25% was thus exceeded. NORMA Group SE does not have a second management level for which the Management Board would also have had to set targets.

At NORMA Group, targets for the management, the Supervisory Board and the top two levels of management were also set for another company, NORMA Germany GmbH. This company is not listed, but codetermined.

COMPETENCE PROFILE, NO SEPARATE DIVERSITY CONCEPT

The objectives for the composition of the Supervisory Board include that all members be independent, no member works for a competitor of NORMA Group, no member who is on the Management Board of a listed company has more than two Supervisory Board mandates in listed companies, no member of the Supervisory Board has significant conflicts of interest and each member complies with the 15-year limit. These goals have all been met. In addition, the Supervisory Board should pay attention to international activities and diversity in proposals for the election of new members. The Supervisory Board has one Swedish member while the other members are German citizens. The current members satisfy the competence profile for the Supervisory Board as a whole. Some members have special knowledge of the industry and NORMA Group's markets, in particular the automotive industry, and NORMA Group's business model. Several members have experience as executives or members of Supervisory Boards as well as international experience. At least one member has expertise in accounting, auditing and controlling. Other areas in which members of the Supervisory Board have special knowledge include risk management, internal control systems and compliance, capital market experience and knowledge of IT systems, including ERP systems. The members of the Supervisory Board also have sufficient time to perform their duties.

No separate diversity concept within the meaning of Section 289f (2) No. 6 HGB has been prepared for the Supervisory and Management Boards of NORMA Group SE. The rules of procedure of the Supervisory Board already stipulate that certain aspects, which the law cites as an example of a concept of diversity, should be taken into consideration in the case of nominations for the elections to the Supervisory Board and the appointment of Management Board members. Diversity should be taken into account in the composition of the Management Board as well as in election proposals for the election of Supervisory Board members. Further requirements for the Supervisory Board already arise from the goals and rules of the procedure described above. The Management Board also has an age limit of 65, which is met by all members. The Supervisory Board focuses on the selection of candidates primarily according to their qualifications. In view of the small number of positions to be filled, six on the Supervisory Board and three on the Management Board, a diversity concept that goes beyond the current requirements hardly seems to offer any advantages.

COMPLIANCE

NORMA Group's compliance organization seeks to prevent violations of laws and other rules, in particular through preventive measures. Nevertheless, if there is evidence of violations, these matters are investigated promptly and thoroughly and the necessary consequences are taken. Findings will be used to take steps to reduce the risk of future violations.

12 The Management Board

13 Letter from the
Management Board

15 NORMA Group on
the Capital Market

20 Supervisory
Board Report

**25 Corporate
Governance
Report**

Group-wide compliance activities are managed by the Chief Compliance Officer of NORMA Group, who reports to the Chief Financial Officer. In addition to the Compliance Department in place at Group level, there are compliance officers at the regional and company levels. The three regional Compliance Officers for the EMEA, Americas and Asia-Pacific regions report to the Chief Compliance Officer. In addition, each operating Group company has its own local Compliance Officer, who reports to the respective Regional Compliance Officer. The Supervisory Board monitors compliance with the compliance rules vis-à-vis the Management Board.

The compliance organization conducts risk analyses together with the relevant units, functions and departments in order to determine and monitor the risk profile of countries, Group companies and functions. On this basis, it identifies the need for action and initiates corresponding measures. Specific employee training courses are held regularly on selected risk areas and important current topics or developments. In 2018, for example, the Compliance Department coordinated a global data protection training course and conducted on-site training sessions at select locations focusing on corruption prevention. Besides training on specific focus topics, all employees worldwide are trained on the basic compliance rules and important contents of the compliance guidelines (in personal or online training sessions). NORMA Group's system-based training administration was also expanded and improved in fiscal year 2018. In addition, employees regularly receive relevant, up-to-date compliance information on a case-by-case basis via various information channels such as the intranet site, brochures, e-mails or notices.

The compliance guidelines of NORMA Group are an important means of communicating to employees the compliance understanding of NORMA Group and of demonstrating their ethical and legal obligations. All compliance documents are reviewed regularly and, if necessary, adapted to new legal or social requirements and thus always kept up to date. Suppliers have their own 'Supplier Code of Conduct.' It is intended to help ensure that laws and ethical rules are observed within the NORMA Group supply chain. A compliance manual also defines in detail the specific areas of responsibility and regulatory areas, describes basic compliance processes, and provides a summary of key compliance issues related to the corresponding compliance guidelines. The compliance manual, as well as the compliance guidelines, are reviewed regularly for changes and updated, if necessary.

NORMA Group encourages its employees to report breaches of regulations and internal policies for all hierarchies. Besides directly approaching superiors, the personnel department or Compliance Officers, an Internet-based 'whistleblower system' is available for this purpose. With this whistleblower system, company-

internal and external parties can report suspicious cases to the compliance organization of NORMA Group and, if necessary, preserve their anonymity.

The members of the compliance organization always follow up on references to compliance violations. If violations of compliance rules are discovered or weaknesses in the organization are identified, management takes the necessary action promptly in cooperation with the compliance organization. Depending on the individual case, these measures range from targeted additional training and changes in organizational processes to disciplinary means, including termination of employment.

SHAREHOLDERS AND ANNUAL GENERAL MEETING

The shareholders of a Societas Europaea decide on the Company's important and fundamental matters. The shareholders exercise their voting rights at the Annual General Meeting, which takes place at least once every year. The Annual General Meeting resolves among other topics on how earnings are to be distributed, the formal approval of the Management Board and the Supervisory Board, the election of the auditor, but also on amendments to the Articles of Association.

Shareholders are entitled to vote if they are registered in the shareholders' register of NORMA Group SE and provide NORMA Group SE or another location specified in the invitation with written notice, in German or English, at least six days before the Annual General Meeting that they will be attending. Each share entitles the bearer to one vote.

NORMA Group SE publishes the invitation and all documents that are to be made available at the Annual General Meeting promptly on its website. Information regarding the number of attendees and the voting results are published there following the Annual General Meeting.  [INVESTORS.NORMAGROUP.COM/AGM](https://www.investors.normagroup.com/agm)

- 12 The Management Board
- 13 Letter from the Management Board
- 15 NORMA Group on the Capital Market
- 20 Supervisory Board Report
- 25 Corporate Governance Report**

SHAREHOLDINGS OF THE MANAGEMENT AND SUPERVISORY BOARD

Of the total of 31,862,400 shares in NORMA Group SE, the current members of the Management Board held a total of 200,820 shares in NORMA Group SE (0.63%) on December 31, 2018. The current members of the Supervisory Board held no shares.

DIRECTORS' DEALINGS

Members of the Management Board and the Supervisory Board and related parties are obliged to disclose Directors' Dealings in NORMA Group SE shares if the value of these transactions reaches or exceeds EUR 5,000 within a calendar year.

In 2018, the following transactions were reported as Directors' Dealings:

T008 DIRECTORS' DEALINGS

Buyer/Seller	Dr. Michael Schneider, Chief Financial Officer
Type of financial instrument	NORMA Group SE Share, ISIN: DE000A1H8BV3
Type of transaction	Purchase
Date of transaction	November 27, 2018
Place of transaction	Xetra
Average price per share	EUR 48.818
Volume	2,050 shares
Total value	EUR 100,077.48

STOCK OPTION PLANS AND EQUITY-BASED INCENTIVE PROGRAMS

The principles of management remuneration are described in the remuneration report which is part of the management report. ► [REMUNERATION REPORT, P. 91](#)

A Long-Term Incentive Program (LTI) was introduced in fiscal year 2013 for the second management level that allows employees to participate in NORMA Group's success over the medium term.

INFORMATION ON THE AUDITOR AND INTERNAL ROTATION

PricewaterhouseCoopers GmbH Wirtschaftsprüfungsgesellschaft (PwC), Frankfurt/Main, audited the financial statements of NORMA Group SE and its predecessor companies as well as the Consolidated Financial Statements for the fiscal years 2010 to 2017. Furthermore, PwC retroactively audited the years 2009 and 2010 for the prospectus as part of the IPO in 2011.

After internal rotation within PwC, Mr. Thomas Tilgner already acted as the auditor signing on the left as part of the audit of the financial statements for the 2016 and 2017 fiscal years. Mr. Benjamin Hessel exercised the office of the undersigning auditor signing on the right for the first time for fiscal year 2018.

1 __ Proven a million times over: Pipe couplings for socketless drain pipes withstand high pressure.



2 __ The pipe couplings guarantee a reliable connection, even with kilometer-long cast iron pipes and fittings.

3 __ Whether they are installed above or in the ground, installation is easy, even when space is limited.

RELIABILITY

RELIABILITY, TODAY AND TOMORROW

We work with our customers today to develop solutions that will be a component in their success in the future. We are aware of our customers' goals and are committed to helping them achieve them. This is how we at NORMA Group define reliability. And our customers reward this with their trust.

Preeyakorn Akravatthanasettha
Order Management
Distribution Services
NORMA Pacific, Thailand



ONE THING IS CERTAIN

The protection of the climate and resources demands that industries take responsibility for further developments. We stand at their side as a reliable partner: with sound knowledge of the trends and markets, open-mindedness, willingness to change and strong relationships.

Even if they might seem nondescript, our products are often mission-critical components in our customers' end products. They rely on these small components, and we are constantly working to make sure they can do so in the future as well. Through reliability, we lay the cornerstone for good and long-lasting customer relations – also and especially against the backdrop of major upheavals. One example is the move away from combustion engines: Whether it is a hybrid drive, fuel cell or battery, car manufacturers do not know yet exactly where the journey will lead. We accompany this change as a competent partner. By providing innovative and

effective joining solutions for all types of drives, we are finding solutions today for the challenges of the future.

RECOGNIZED

Our customers can also rely on our special commitment: Within a few weeks, one of our teams developed a complete prototype set of cooling water pipes for a 26-ton electric truck. These employees were recognized for their commitment with our internal Innovation Award.

RESIDENT ENGINEERS: THINKING CUSTOMER PROXIMITY EVEN FURTHER

In order to achieve the best possible results for our customers, we enter into long-term development partnerships. Our engineers work on site as part of

the customer's team. At the end, this leads to product and system solutions that exactly and holistically fit the end product of the manufacturer. Due to intensive cooperation, our experts also gain valuable knowledge of customer requirements and markets.

DELIVERY RELIABILITY AT ITS BEST

30 production sites spread across 16 countries. We deliver reliably wherever our customers manufacture. Efficient processes, flexible orientation to the customer's needs and maximum control of the flow of information and materials make us a reliable partner.

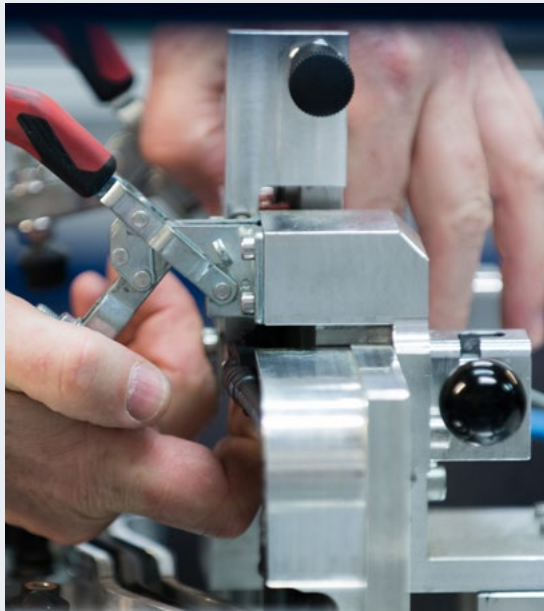

Gauge
to check the shape
accuracy and
tightness of pipes

STRONG RELATIONSHIPS DIGITALLY SUPPORTED

Good relationships are based on continuity and intensive care. This is why NORMA Group uses Customer Relationship Management (CRM). This software allows us to record and evaluate all customer interactions. In this way, we constantly develop our processes further, ensure transparent knowledge management and optimize our customer orientation.

“THE CAPITAL MARKET
APPRECIATES ACCURATE
FORECASTS.”

DIGGING DEEPER

Interview with NORMA Group’s Investor Relations department

How does NORMA Group create confidence on the capital market?

Our equity story serves as the basis for our activities and communication. We supplement this with consistent and regular explanations of our financial figures, results and other relevant information. We also regularly exchange information with analysts and private and institutional investors. The capital market appreciates this reliability of contact and transparency in providing information and therefore gives us its trust. To maintain that, we, in turn, make sure we are available for all shareholders.

What do you tell shareholders with regard to the lower EBITA margin in fiscal year 2018?

When we listen to the radio in the morning or watch the evening news, but also when we look at the state of the capital market, we can see what challenging times the world is facing – no matter whether it’s society, politics or the economy. Not just we but also the entire industry has felt the impact of this. But especially in difficult times, we are committed to communicating transparently and calling a spade a spade. This is also the case with our ad hoc announcement on the adjustment of the forecast in July 2018.

What is more important from an investor’s point of view: unexpected positive results or accurate forecasts?

Generally speaking, the capital market appreciates accurate forecasts – in the sense of reliability and transparency. If it isn’t possible to avoid reporting the unexpected, then it is good to be able to share good news.

INTRODUCTION

OUR VISION

TO OUR SHAREHOLDERS

**CONSOLIDATED
MANAGEMENT REPORT**

CONSOLIDATED
FINANCIAL STATEMENTS

FURTHER INFORMATION

CONSOLIDATED MANAGEMENT REPORT

- 37 Principles of the Group
- 51 Economic Report
- 74 Forecast Report
- 79 Risk and
Opportunity Report
- 91 Remuneration Report
- 98 Other Legally
Required Disclosures
- 101 Report on Transactions
with Related Parties

PRINCIPLES OF THE GROUP
ECONOMIC REPORT
FORECAST REPORT
RISK AND OPPORTUNITY REPORT
REMUNERATION REPORT
OTHER LEGALLY REQUIRED DISCLOSURES
REPORT ON TRANSACTIONS WITH RELATED PARTIES



37 Principles of the Group

51 Economic Report

74 Forecast Report

79 Risk and
Opportunity Report

91 Remuneration Report

98 Other Legally
Required Disclosures101 Report on Transactions
with Related Parties

CONSOLIDATED MANAGEMENT REPORT

PRINCIPLES OF THE GROUP

BUSINESS MODEL

NORMA Group is an international market and technology leader in the area of advanced and standardized connecting technology (joining, mounting and fluid handling technology). With its 30 production sites and numerous sales offices, the Group has a global network with which it supplies more than 10,000 customers in more than 100 countries. NORMA Group's product portfolio includes more than 40,000 high-quality joining products and solutions in the three product categories clamps (CLAMP), joining elements (CONNECT) and fluid systems/connectors (FLUID). The products NORMA Group offers are used across industries in a wide range of applications, whereby the product specifications differ depending on the application and customer requirements.

High customer satisfaction forms the foundation of NORMA Group's continued success. The main factors here are the customized system solutions, the global availability of products in consistently high quality, delivery reliability and a strong brand image.

By opening new plants and competence centers and making strategic acquisitions, NORMA Group has succeeded in expanding its international presence quite significantly in recent years while optimizing its distribution channels and intensifying its cooperation with local customers.

ORGANIZATIONAL STRUCTURE

CORPORATE LEGAL STRUCTURE

NORMA Group SE is the parent company of NORMA Group. It has its headquarters in Maintal near Frankfurt/Main, Germany. NORMA Group SE serves as the formal legal holding of the Group. It is responsible for the strategic management of business activities. In addition, it is also responsible for communicating with the Company's most important target audiences as well as Legal and M&A, Compliance, Risk Management and Internal Revision.

Group-wide central management responsibilities such as IT, Treasury, Group Accounting and Group Controlling, are all based at the 100% subsidiary NORMA

Group Holding GmbH which is also located in Maintal. Three regional management teams located in Auburn Hills (USA), Maintal (Germany) and Singapore steer the specific holding activities for the three regions Americas (North, Central and South America), EMEA (Europe, Middle East and Africa) and Asia-Pacific (APAC).

As of December 31, 2018, NORMA Group SE holds shares in 51 companies that belong to NORMA Group either directly or indirectly and are fully consolidated.

► **NOTES, P. 134**

ACQUISITIONS AND CHANGES OF LEGAL STRUCTURE

NORMA Group SE made three acquisitions and acquired the remaining minority interests in another company in fiscal year 2018.

In July 2018, the Company acquired 100% of the shares in the Indian company Kimplas Piping Systems Ltd. (including the English subsidiary Kimplas Limited 'Kimplas'), a company that specializes in water management systems. With the acquisition of Kimplas, NORMA Group is expanding its activities in the fast-growing market for water management systems and at the same time increasing its presence in one of the world's most important emerging markets.

In July 2018, NORMA Group also acquired the remaining 10% of the shares in Groen Bevestigingsmaterialen B.V. in the Netherlands, in which it had previously held 90%. As a result, NORMA Group now holds all the shares in the company via NORMA Group Holding GmbH and NORMA Netherlands B.V.

In August 2018, NORMA Group also completed the acquisition of 100% of the shares in the Maintal-based supplier Statek Stanzertechnik GmbH ('Statek'). Statek has many years of experience and extensive manufacturing know-how in stamping, bending and forming technology for virtually all common metals and has been supplying NORMA Group for many years. With Statek's technological expertise, NORMA Group is systematically expanding its value chain while at the same time increasing its flexibility in key product areas. Following the acquisition by NORMA Group, Statek concluded a control and profit and loss transfer agreement with its sole shareholder, NORMA Group Holding GmbH, with effect

37 Principles of the Group

51 Economic Report

74 Forecast Report

79 Risk and
Opportunity Report

91 Remuneration Report

98 Other Legally
Required Disclosures101 Report on Transactions
with Related Parties

from January 1, 2019. This does not affect the control agreements in force from the date of entry in the commercial register of Statek on October 30, 2018.

In October 2018, NORMA Group completed the liquidation of the Australian company Guyco Pty. Ltd. after the business operations had previously been transferred to the parent company, the Australian company NORMA Pacific Pty. Ltd. That same month, NORMA Group also established NG AM FINSRV I, LLC in the US in connection with an asset-backed securities program. ► **NOTES, P. 133**

In November 2018, NORMA Group opened a new plant in Tijuana, Mexico, and in this context established NORMA MANUFACTURING NA SW, LLC. ► **SIGNIFICANT DEVELOPMENTS IN FISCAL YEAR 2018, P. 54**

GROUP MANAGEMENT

NORMA Group SE has a dual management system that consists of a Management Board and a Supervisory Board. The Management Board manages the Company under its own responsibility, while the Supervisory Board advises and monitors the Management Board. In fiscal year 2018, the following personnel changes took place in the Management Board:

As of December 31, 2017, Werner Deggim, the former Chairman of the Management Board, resigned from the Board at his own request for age reasons. Bernd Kleinhens took over as Chairman of the Management Board on January 1, 2018. From 2011 to the end of 2017, Mr. Kleinhens held the position of Chief Business Development Officer at NORMA Group and has been with the Company and its predecessor companies since 1991.

In addition, Chief Operating Officer John Stephenson resigned from the Management Board at his own request at the end of January 2018. As his position could not be filled immediately and the position of Board member responsible for Business Development will no longer be filled, the Management Board only consisted of two persons on an interim basis in the period from February to September 2018.

On October 1, 2018, Dr. Friedrich Klein assumed the position of Chief Operating Officer (COO). Dr. Klein has many years of experience and expertise in the automotive sector. He joined NORMA Group from Schaeffler Technologies AG & Co KG, a global automotive and industrial supplier. In his last position as Head of Bearing and Components Technologies, he was responsible for the worldwide development and production of rolling bearings. He was also responsible for restructuring the global production network and expanding production services. With the arrival of Dr. Klein, the Management Board is now complete again.

In accordance with the Articles of Association, the Supervisory Board of NORMA Group SE consists of six independent members elected by the shareholders at the Annual General Meeting. When the terms of office of all Supervisory Board members expired in the fiscal year 2018, the re-election of five previously acting members of the Supervisory Board and the election of a new candidate were on the agenda of the Annual General Meeting on May 17, 2018. In individual elections, 50.4% of the registered shareholders voted against re-electing the Chairman of the Supervisory Board, Dr. Stefan Wolf. The remaining candidates were re-elected with the necessary majority. In addition, the Annual General Meeting elected Rita Forst as new member of the Supervisory Board. Rita Forst replaces Dr. Christoph Schug, who did not stand for re-election. Following the Annual General Meeting, the Supervisory Board elected Lars Magnus Berg as Chairman of the Supervisory Board. Erika Schulte was elected Vice Chairwoman of the Supervisory Board. In the period between the Annual General Meeting and September 2018, the Supervisory Board of NORMA Group consisted of only five members. In September 2018, the competent court appointed Mark Wilhelms to the Supervisory Board of NORMA Group, following the proposition of the Management Board. Mark Wilhelms has been a member of management of Stabilus S.A., Luxembourg, since 2009. In 2014, he was appointed Chief Financial Officer (CFO) of Stabilus S.A. and Managing Director of Stabilus GmbH. Mark Wilhelms has many years of experience and expertise in both finance and information technology (IT), for which he was responsible at management level in the international automotive industry.

Detailed information on the composition of the Management Board and the Supervisory Board, as well as the distribution of responsibilities among themselves, can be found in the Corporate Governance Report, which forms part of the Annual Report. The Statement of Corporate Governance pursuant to Section 289f HGB, including the Declaration of Conformity pursuant to Section 161 AktG, a description of the procedures of the Management Board and the Supervisory Board, relevant information on corporate governance practices and a declaration regarding the concept of diversity to be disclosed under the CSR Directive Implementation Act are also part of the Corporate Governance Report. ► **CORPORATE GOVERNANCE REPORT, P. 25** The curriculum vitae of the Supervisory and Management Board members are published on NORMA Group's website.  [INVESTORS.NORMAGROUP.COM](http://www.investors.normagroup.com)

37 Principles of the Group

- 51 Economic Report
- 74 Forecast Report
- 79 Risk and Opportunity Report
- 91 Remuneration Report
- 98 Other Legally Required Disclosures
- 101 Report on Transactions with Related Parties

G 007 ORGANIZATIONAL STRUCTURE OF NORMA GROUP

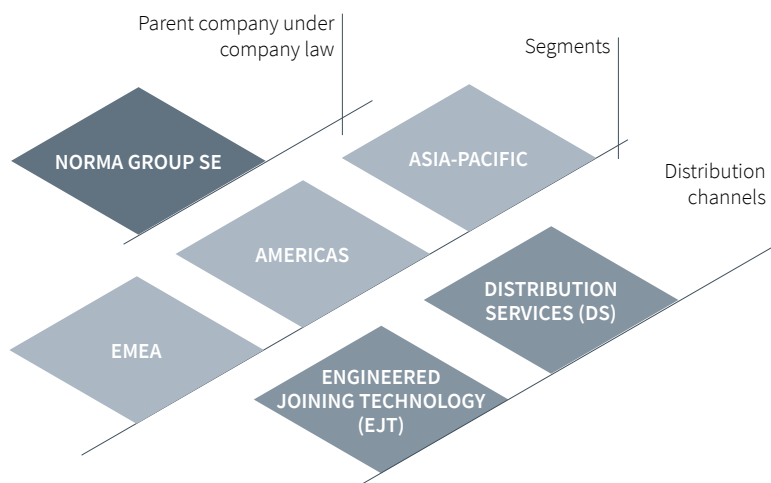

OPERATIVE SEGMENTATION BY REGIONS

NORMA Group's strategy is based, among other considerations, on regional growth targets. In order to achieve these, the operative business is managed by the three regional segments EMEA, the Americas and Asia-Pacific. All three regions have networked regional and cross-company organizations with different functions. The internal Group reporting and control system that Management uses is also therefore quite regional in nature. Distribution Services is based on regional and local priorities.

G 008 NORMA GROUP (SIMPLIFIED STRUCTURE) ¹

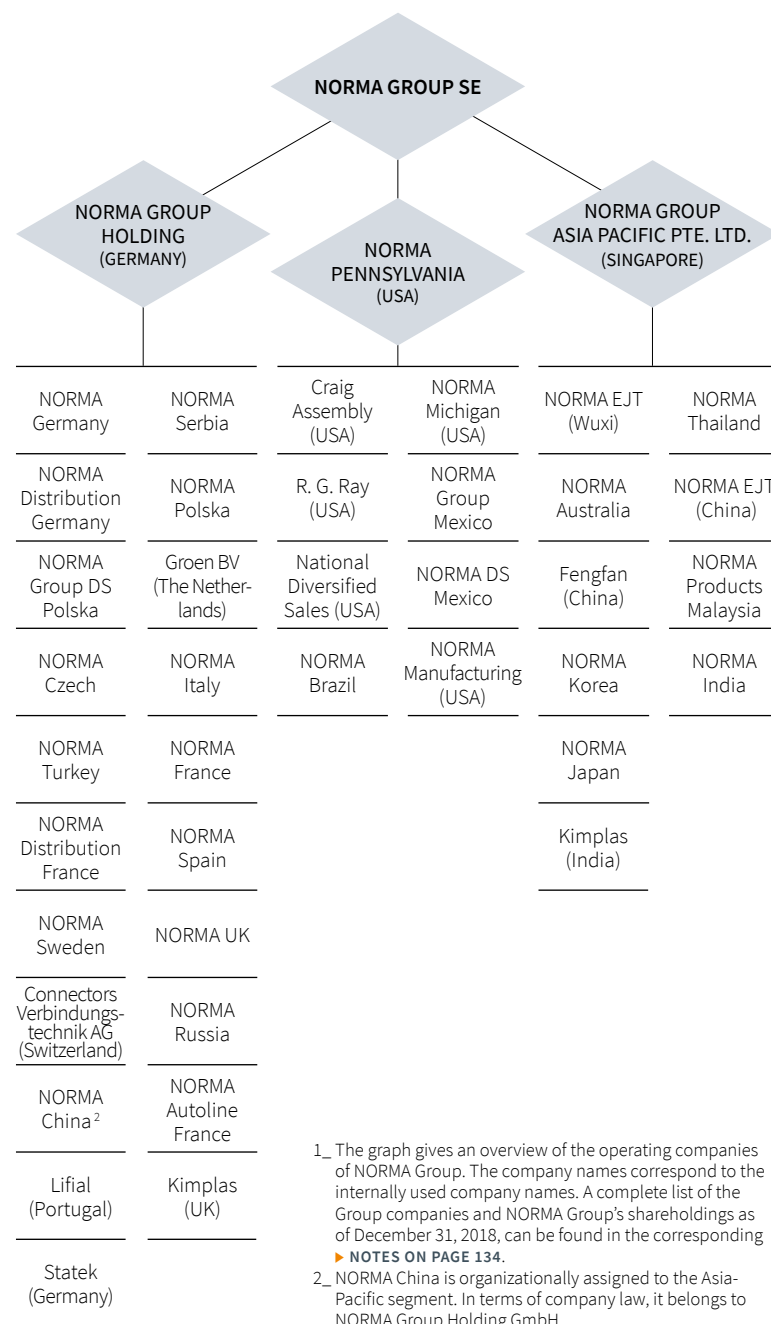

1_ The graph gives an overview of the operating companies of NORMA Group. The company names correspond to the internally used company names. A complete list of the Group companies and NORMA Group's shareholdings as of December 31, 2018, can be found in the corresponding **NOTES ON PAGE 134**.

2_ NORMA China is organizationally assigned to the Asia-Pacific segment. In terms of company law, it belongs to NORMA Group Holding GmbH.

37 Principles of the Group

51 Economic Report

74 Forecast Report

79 Risk and
Opportunity Report

91 Remuneration Report

98 Other Legally
Required Disclosures

101 Report on Transactions
with Related Parties

PRODUCTS AND END MARKETS

PRODUCT PORTFOLIO

The products that NORMA Group offers can for the most part be divided into the three product categories clamps (CLAMP), joining elements (CONNECT) and fluid systems/connectors (FLUID).

The clamp products (CLAMP) are manufactured from unalloyed steels or stainless steel and are generally used to join or seal elastomer hoses.

The connection products (CONNECT) include connectors made of unalloyed steels or stainless steel that are partly equipped with elastomer or metal seals and are used as the joining and sealing elements of metal and thermoplastic pipes.

The FLUID products are single or multiple layer thermoplastic plug-in connectors and liquid systems that reduce installation times, ensure reliable flow of liquids or gases and occasionally replace conventional products such as elastomer hoses. NORMA Group's fluid products are used in thermal management systems in hybrid and electric vehicles, among other applications. In addition, the FLUID product portfolio includes solutions for applications in the sectors of storm water management and landscape irrigation, but also joining components for infrastructure solutions in the area of water.

NORMA Group's advanced engineered joining technology is used in all applications in which pipelines, tubes and other systems need to be connected together. Because joining technology plays a role in nearly all industries, NORMA Group serves many different end markets. Besides the automotive, commercial vehicle, and aviation industry, NORMA Group is also active in the construction and mechanical engineering industry, the pharmaceutical and biotechnology fields, agriculture and the drinking water supply and irrigation industry. NORMA Group products are also used in consumer products such as home appliances.

TWO COMPLEMENTARY DISTRIBUTION CHANNELS

NORMA Group supplies its customers via two different sales channels,

Engineered Joining Technology – EJT and Distribution Services – DS.

The two distribution channels differ in terms of the degree of specification of the products, while having intersections in production and development that enable cost benefits and ensure the highest quality standards.

The area of **EJT** includes sophisticated, individually customized joining technology and is particularly characterized by close development partnerships with OEMs (original equipment manufacturers). NORMA Group's central development departments and resident engineers work together with the customer on developing solutions for specific industrial challenges. Due to the constant proximity to customers in the area of EJT, NORMA Group's engineers gain comprehensive knowledge and a deep understanding of the various challenges their end markets and customers face. Such development partnerships result in high-technology products that are designed not only to meet the needs of customers with respect to efficiency and performance, but that also take aspects such as weight reduction and quick installation into consideration. As a result, they generate substantial added value for the customers and contribute to their economic success.

Via its **Distribution Services (DS)**, NORMA Group markets a broad range of high-quality, standardized brand products. In addition to its own global distribution network, the Company also relies on multipliers such as sales representatives, retailers and importers. Its customers include, among others, distributors, specialized wholesalers, OEM customers in the aftermarket segment, do-it-yourself stores and applications in smaller industries. The brands ABA®, Breeze®, Clamp-All®, CONNECTORS®, FISH®, Five Star®, Gemi®, NDS®, NORMA®, Raindrip®, R.G.RAY®, Serflex® and TORCA® exemplify technological know-how, high quality and reliability and meet the technical standards of the countries in which they are sold.

NORMA Group combines its expertise in developing tailor-made solutions for industrial customers (EJT) with its global sales of high-quality standardized brand products (DS) to realize not only cross-selling effects, but also numerous synergies in production, logistics and sales. The Company also benefits from significant economies of scale and scope thanks to the diversity and high volumes of its product offerings, a clear distinction from its smaller, generally more specialized competitors.

37 Principles of the Group

- 51 Economic Report
- 74 Forecast Report
- 79 Risk and Opportunity Report
- 91 Remuneration Report
- 98 Other Legally Required Disclosures
- 101 Report on Transactions with Related Parties

G 009 SALES BY DISTRIBUTION CHANNEL ¹

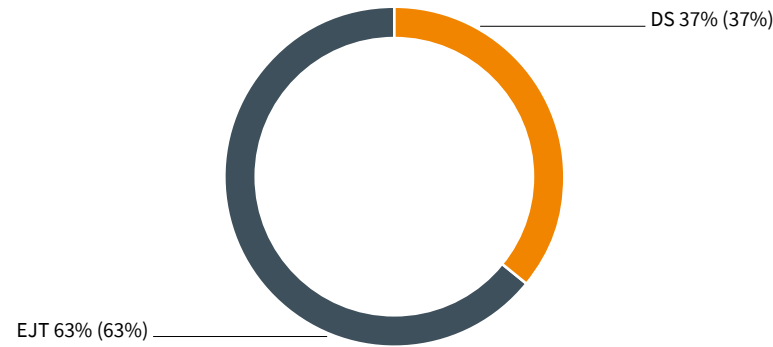

1_Previous year's values in brackets

MARKET AND COMPETITIVE ENVIRONMENT

With its products, NORMA Group provides solutions for numerous industrial applications. Its expertise covers metal-based connection solutions and products (CLAMP and CONNECT) as well as thermoplastic materials (FLUID). Thanks to the unique combination of expertise in both metal and plastics processing and the broad diversification of its product portfolio, NORMA Group can offer its customers a wide range of solutions to different problems from a single source and thus distinguishes itself from its competitors who mainly specialize in individual product segments.

In the area of Engineered Joining Technology, especially in the area of CLAMP and CONNECT, NORMA Group operates in a highly fragmented market, which is characterized by a very heterogeneous structure due to the abundance of specialized industrial companies. In this environment, NORMA Group sees itself as a provider of tailor-made, value-creating solutions that are geared to the specific needs of the customer and are developed in long-term partnerships. With its international business alignment and its cross-industry customer base, NORMA Group distinguishes itself from its mostly regional competitors.

In the area of FLUID, NORMA Group finds itself facing mainly competitors that are globally active and mainly offer elastomer products. NORMA Group, however, has focused more on innovative plastic-based solutions that generate significantly higher value for its customers due to their lower weight and price, as well as the environmental compatibility of the materials used.

In the much more standardized sales channel Distribution Services, NORMA Group operates in mass markets and competes primarily with providers of similar standardized products. It differentiates itself from them particularly through its strong brands that are the result of a deliberate brand policy that focuses on the regional needs of its customers. In addition, customers appreciate the high quality of service. NORMA Group offers its trade customers a complete range of products that meets all of their end users' needs as well as short delivery times and permanent availability.

T 009 OVERVIEW OF END MARKETS AND BRANDS BY SEGMENTS

Segment	Product categories	Distribution channels	End markets	Brands
EMEA	CLAMP	EJT	Industrial suppliers	ABA®,
	CONNECT	DS	Passenger vehicle OEMs	CONNECTORS®,
	FLUID		Distributors Commercial vehicle OEMs Pharma / Biotechnology Water management	Gemi®, NORMA®, Serflex®
Americas	CLAMP	EJT	Industrial suppliers	ABA®, Breeze®,
	CONNECT	DS	Passenger vehicle OEMs	Clamp-All®,
	FLUID		Distributors Commercial vehicle OEMs Pharma / Biotechnology Water management	Five Star®, Gemi®, NDS®, NORMA®, Raindrip®, R.G.RAY®, TORCA®
Asia-Pacific	CLAMP	EJT	Industrial suppliers	ABA®, Breeze®,
	CONNECT	DS	Passenger vehicle OEMs	FISH®, Gemi®,
	FLUID		Distributors Commercial vehicle OEMs Pharma / Biotechnology Water management	NORMA®

37 Principles of the Group

51 Economic Report

74 Forecast Report

79 Risk and
Opportunity Report

91 Remuneration Report

98 Other Legally
Required Disclosures101 Report on Transactions
with Related Parties**GOALS AND STRATEGY****VISION 2025**

The long-term strategy of NORMA Group is based on the so-called 'Vision 2025', which was approved by the Management Board and has been rigorously pursued in fiscal year 2018. Vision 2025 includes increasing the value creation of NORMA Group as its central objective, building on NORMA Group's successful entrepreneurial development and focusing on sustained sales growth, profitability above the industry average and the efficient deployment of capital. On its way to achieving these goals, NORMA Group is pursuing a stakeholder-oriented approach that is geared both toward the demands of its customers for innovative and value-creating solutions and to the interests of its shareholders and suppliers. In order to achieve these goals, NORMA Group seeks to offer its employees an environment geared toward continuous improvement, thereby strengthening its position as the employer of choice. At the same time, NORMA Group regards it as a central component of its corporate responsibility to reconcile the effects of its business activities with the expectations and needs of society. For this reason, the management bases all entrepreneurial decisions on the principles of responsible corporate management and sustainable action. Corporate Responsibility (CR), NORMA Group's responsibility towards people and the environment, is therefore an integral part of the Company strategy.

▶ **2018 CR REPORT**

The Vision 2025 is based on the following key objectives and strategic measures:

1. Increase market share through further localization

Increasing the Company's market share is the primary objective of NORMA Group. In each regional segment and in both sales divisions (EJT and DS), the focus is on the ongoing profitable expansion of business activities and increasing market share. At the heart of NORMA Group's growth strategy is the expansion of its product portfolio and regional presence, as well as the opening up of new end markets. The continuous expansion of application solutions for current EJT customers, the identification and acquisition of new EJT customers, the deepening of the customer base in Distribution Services (DS) and the identification of new markets with attractive growth potential will all be used to expand business activities and further strengthen the Group's international presence. In identifying new end markets, NORMA Group places a strategic focus on niche markets with attractive margins, advanced products, strongly growing sales potential and a fragmented competitive structure. The goal is to achieve broad diversification in the end markets through the targeted transfer of knowledge to new, high-growth industries. This will strengthen the sustainable earnings profile, the independence from economic influences and the stability of the business.

Global megatrends such as climate change and resource scarcity offer NORMA Group attractive growth potential. The strategic focus is therefore on future-oriented applications in the fields of water management and electromobility. ▶ **PRODUCTS AND END MARKETS, P. 40**

2. Diversification of product portfolio

The technological requirements placed on the end products of NORMA Group customers are constantly changing. Increasing environmental awareness, scarcity of resources and growing cost pressures play a major role in almost every sector of industry. Furthermore, the automotive and commercial vehicle industries, in particular, are subject to stricter emission regulations and special requirements for the materials used. This is also accompanied by increasing technological change, away from conventional combustion engines towards alternative powertrain techniques such as hybrid or electromobility. ▶ **LEGAL AND REGULATORY INFLUENCING ASPECTS, P. 53** These form the starting point for the development of new products. NORMA Group focuses on value-enhancing solutions that support its customers in reducing emissions, leaks, weight, space and assembly time. Innovations play an important role in meeting the increasing customer demands that accompany each new production cycle. This is why NORMA Group's more than 350 engineers and developers are constantly working on developing new products and optimizing the currently used processes and systems. An important focus here is on the development of solutions for electromobility. This offers NORMA Group numerous opportunities, particularly in the field of vehicle thermal management. In order to sustainably strengthen its innovative strength, the Group plans to invest around 5% of its EJT sales in research and development activities each year. ▶ **RESEARCH AND DEVELOPMENT, P. 48**

Although the joining products that NORMA Group sells make up a relatively small value proportion of the final product, they are often mission-critical. Sticking to the highest quality standards and stringent quality management throughout the entire Group therefore play a crucial role. ▶ **QUALITY MANAGEMENT, P. 66** A strong brand strategy geared toward regional growth targets, as well as ensuring first-class service quality and product availability at all times, are also important success parameters. NORMA Group ensures this through its worldwide sales network.

**MARKET LEADER IN CONNECTING
AND FLUID HANDLING TECHNOLOGY
FOR EXISTING AND FUTURE MARKETS**

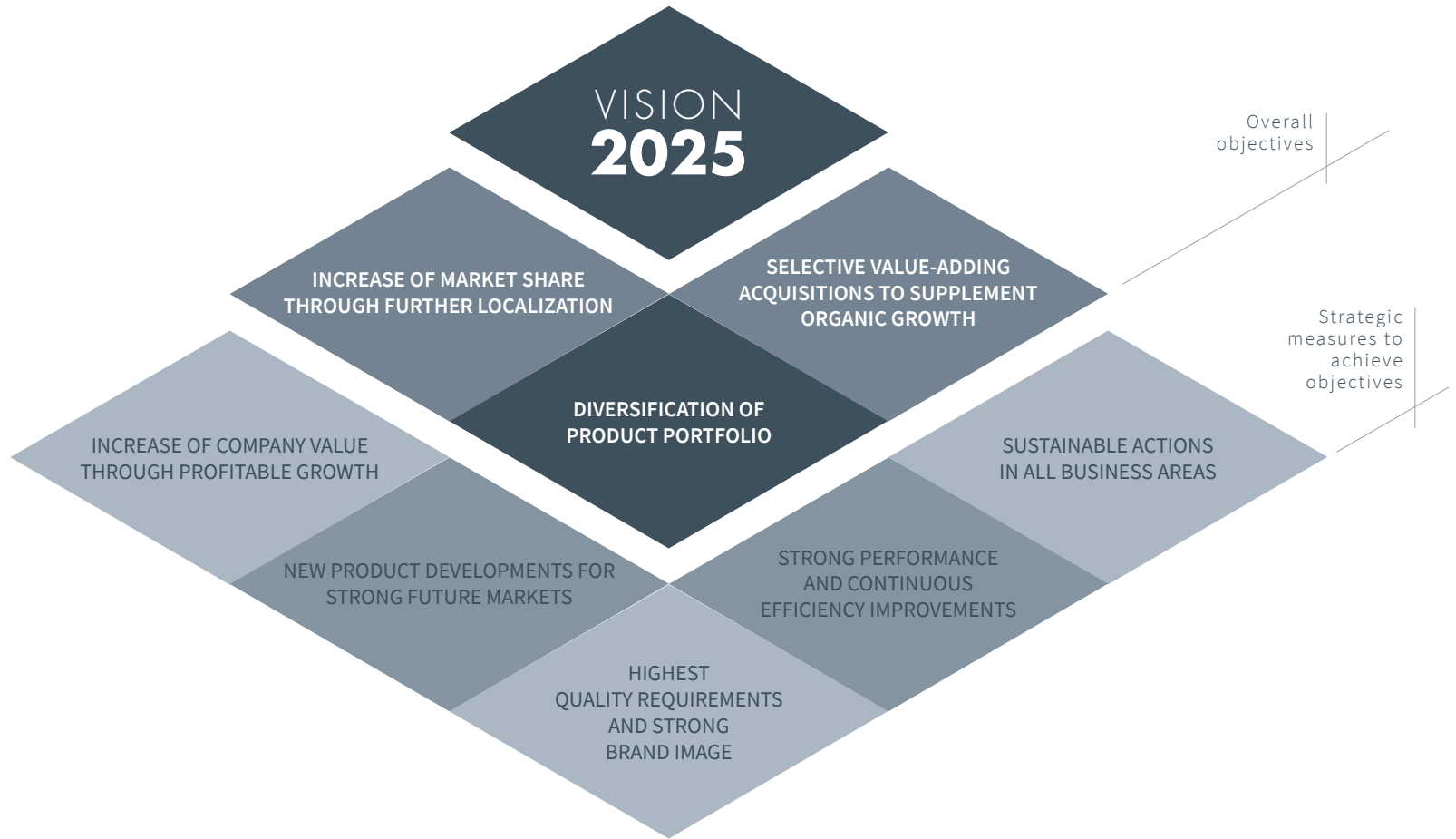

37 Principles of the Group

51 Economic Report

74 Forecast Report

79 Risk and
Opportunity Report

91 Remuneration Report

98 Other Legally
Required Disclosures

101 Report on Transactions
with Related Parties

CLIMATE CHANGE AND SCARCITY OF RESOURCES
ARE GLOBAL MEGATRENDS WHICH FORM THE BASIS FOR
NORMA GROUP'S BUSINESS MODEL

INTRODUCTION

OUR VISION

TO OUR SHAREHOLDERS

**CONSOLIDATED
MANAGEMENT REPORT**

CONSOLIDATED
FINANCIAL STATEMENTS

FURTHER INFORMATION

37 Principles of the Group

51 Economic Report

74 Forecast Report

79 Risk and
Opportunity Report

91 Remuneration Report

98 Other Legally
Required Disclosures

101 Report on Transactions
with Related Parties

3. Selective value-adding acquisitions to supplement organic growth

By making select acquisitions, NORMA Group contributes to the diversification of its business and strengthens its growth. Acquisitions are therefore an integral part of the Company's long-term growth strategy. NORMA Group observes the joining technology market very closely and contributes to its consolidation through targeted acquisitions. In total, NORMA Group has acquired 14 companies since the IPO in 2011 and integrated them into the Group. The main focus of M&A activities is always on companies that help to realize the diversification objectives of NORMA Group, to strengthen its competitive position and/or to generate synergies. The preservation of growth and high profitability also play an important role. The search for suitable companies focuses on the automotive and water management sectors. Since acquiring the US water specialist National Diversified Sales (NDS) in fiscal year 2014, NORMA Group has built up an established market position in the fast-growing water industry, which it wants to expand through further acquisitions in this area.

STRATEGIC OUTLOOK FOR FISCAL YEAR 2019

In February 2019, the Management Board of NORMA Group announced the introduction of a rightsizing program for the long-term optimization of the Group's structures.

NORMA Group has grown rapidly in recent years, both organically and through acquisitions. This has also been accompanied by rapid growth in the production landscape and organizational structures. In order to further harmonize processes and systems within the Group and thus lay the foundations for further growth, optimization measures are to be implemented in all regions, EMEA, the Americas and Asia-Pacific, in the years to come. The objective is also to focus the business model on the requirements of future strategic growth areas such as electromobility and water management.

The measures already implemented and planned are expected to result in an annual positive earnings contribution (adjusted EBITA) of around EUR 10 million to EUR 15 million from 2021 on.

The Management Board estimates the total costs of the project at around EUR 10 million to EUR 15 million. They are to be spread out over a period of approximately two years. Around EUR 2.2 million of this amount was already incurred in the past fiscal year 2018. ► **SIGNIFICANT DEVELOPMENTS IN FISCAL YEAR 2018, P. 54**

The costs incurred by this project are shown in adjusted form. ► **NOTES, P. 141**



37 Principles of the Group

51 Economic Report

74 Forecast Report

79 Risk and
Opportunity Report

91 Remuneration Report

98 Other Legally
Required Disclosures101 Report on Transactions
with Related Parties**CONTROL SYSTEM AND CONTROL PARAMETERS**

The consistent focus on the Group objectives mentioned is also reflected in the internal control system at NORMA Group, which relies on both financial and non-financial control parameters.

IMPORTANT FINANCIAL CONTROL PARAMETERS

The following value-based indicators, which have a direct impact on value creation at NORMA Group, are among the Company's most important financial performance indicators: organic Group sales growth, profitability (adjusted EBITA margin) and net operating cash flow. These key figures form the so-called NORMA Value Added (NOVA) as a central strategic target figure. Since the NOVA is also a reference value for the long-term remuneration of the Management Board, it was added to the control system in fiscal year 2018.

► **REMUNERATION REPORT, P. 91**

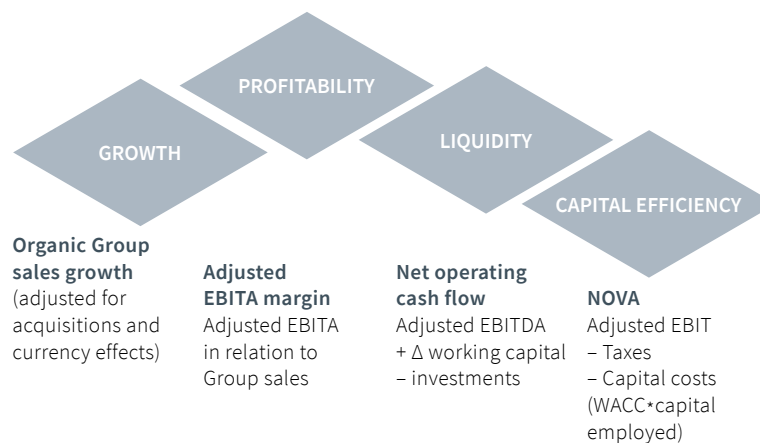
G 011 IMPORTANT FINANCIAL CONTROL PARAMETERS**Organic sales growth**

As a growth-oriented Company, NORMA Group attaches particular importance to profitable growth in sales. The Group seeks to achieve short- and medium-term growth above the market average. This refers to internal growth excluding currency effects. In addition, sales revenues from newly acquired companies are reported separately within the first 12 months of initial consolidation (sales revenues from acquisitions).

Due to the broad market structure in the area of joining technology, the Management Board is guided by internal analyses as well as studies by leading economic research institutes on the development of the gross domestic product of the respective regions and on the production and sales figures of the relevant customer industries in developing the forecast on the expected development of sales. In addition, the management observes certain early indicators, such as customer order patterns in the retail business (Distribution Services) and the order book in the area of Engineered Joining Technology (EJT).

Adjusted EBITA and adjusted EBITA margin

The adjusted EBITA (EBITA before special influences) is the most important internal and external performance indicator for ongoing operations. In order to be able to make a long-term comparison and for a better understanding of how the business is developing, NORMA Group adjusts the operating result by certain expenses, for example those that are related to acquisitions. ► **NOTES, P. 141**

Adjusted EBITA margin (EBITA as a percentage of sales) as another key indicator for NORMA Group provides information on the profitability of its business activities. In order to maintain the adjusted EBITA margin and thus the Group's profitability at its high level, NORMA Group continuously works on optimizing its business processes.

To determine the EBITA target margin, both the historic performance and the planning of individual business units are taken into consideration. The target margin for the Group is determined as the weighted average of the divisions. The price development of the raw materials of greatest importance to NORMA Group serves as an early indicator of changes in major cost items, such as material costs. For this reason, the respective markets and raw material prices are constantly monitored and the prices of key materials are contractually fixed.

Net operating cash flow

In order to maintain the Group's financial independence and solvency at all times, NORMA Group is guided by net operating cash flow in addition to the aforementioned key figures. Net operating cash flow includes the most important cash-effective items that can be influenced by the individual business units and provides information on whether NORMA Group can finance its operating business out of its cash flow. It is calculated on the basis of the adjusted EBITDA plus changes in working capital minus capital expenditures. The key approaches to improving net operating cash flow are therefore to increase sales, to improve the adjusted operating result (adjusted EBITDA) and to engage in sustained value-enhancing investment activity. In addition, consistent management of working capital also has a positive effect on net operating cash flow.

37 Principles of the Group

51 Economic Report

74 Forecast Report

79 Risk and
Opportunity Report

91 Remuneration Report

98 Other Legally
Required Disclosures101 Report on Transactions
with Related Parties**NORMA Value Added (NOVA)**

NORMA Group's goal is to use the capital provided by its shareholders and lenders as efficiently as possible in order to secure the Group's long-term positive development. In order to manage this, NORMA Group determines the annual value creation in the form of the so-called NORMA Value Added (NOVA). NORMA Value Added is calculated on the basis of adjusted EBIT, the tax rate and the cost of capital. The cost of capital is defined by the weighted average cost of capital (WACC) and capital employed (equity plus net debt).

$$\text{NOVA} = (\text{adjusted EBIT} \times (1 - t)) - (\text{WACC} \times \text{capital employed})$$

T 010 ADJUSTED EBIT AFTER TAXES

	2018	2017
Adjusted EBIT (in EUR millions)	164.5	166.0
Group tax rate (in %)	24.9	30.0
Taxes (in EUR millions)	41.0	49.8
Adjusted EBIT after taxes (in EUR millions)	123.5	116.2
- WACC * capital employed	62.8	61.4
NOVA (in EUR millions)	60.8	54.8

T 011 CAPITAL EMPLOYED AS OF BEGINNING OF THE YEAR (JAN 1)

	2018	2017
Equity (in EUR millions)	534.3	483.6
Net debt (in EUR millions)	344.9	394.2
Capital employed (in EUR millions)	879.2	877.8

The cost of capital rate is calculated on the basis of the following assumptions and calculations:

T 012 ASSUMPTIONS FOR THE CALCULATION OF THE WACC

IN %	2018	2017
Risk-free interest rate	0.39	0.41
Market risk premium	6.50	6.50
Beta factor of NORMA Group	1.28	1.13
Cost of equity rate	9.41	8.34
Borrowing cost rate after taxes	1.85	2.18
WACC after taxes	7.14	6.99

The financial control parameters are planned and continuously monitored in the Group, but also for the most part at the segment and Group company levels. Deviations between planned and actually achieved values are tracked in the local companies and aggregated at the regional segment level as part of the monthly analysis. Business development is regularly forecast on the basis of available monthly and quarterly results and under the assumption of various scenarios.

IMPORTANT NON-FINANCIAL CONTROL PARAMETERS

The most important non-financial control parameters for NORMA Group include the extent of market penetration, the Group's power of innovation, the problem-solving behavior of its employees and the sustainable overall development of NORMA Group as a whole.

Market penetration

NORMA Group always pursues the objective to sustainably expand its business and achieve sales growth and profitability that are higher than average by industry comparison. Particularly by offering innovative solutions, NORMA Group is able to create value creation potential in various areas of application and numerous industries. The Group's organic growth is thus a sign of NORMA Group's market penetration.

Invention applications

The Group considers ensuring an environment of sustainable innovation a key driver of future growth. NORMA Group therefore measures and controls the number of annual invention applications. NORMA Group employees submit invention applications as part of an internal formalized process upstream of the external process of new patent applications. By establishing targeted internal incentive systems, NORMA Group promotes its employees' innovative thinking.

37 Principles of the Group

51 Economic Report

74 Forecast Report

79 Risk and
Opportunity Report

91 Remuneration Report

98 Other Legally
Required Disclosures101 Report on Transactions
with Related Parties**Quality KPIs**

NORMA Group stands for the highest possible reliability and quality of service. The reputation of its brands and reliability of its products are key factors in the Company's success. In developing and manufacturing products, the Group therefore relies on the highest quality standards. In order to minimize production losses and maximize customer satisfaction, NORMA Group measures and manages the problem solving behavior of its employees by using two performance indicators: the average number of customer complaints per month and defective parts per million of manufactured parts (parts per million/PPM). The two metrics are collected and aggregated at Group level on a monthly basis. ► **QUALITY MANAGEMENT, P. 66**

Other non-financial performance indicators

Other non-financial performance indicators include employee and environmental indicators and indicators on occupational safety and healthcare within the Group. More information can be found in the ► **2018 CR REPORT**.

The target figures for the financial and non-financial control parameters for 2019 and the assumptions underlying the forecast are presented in the Forecast Report ► **FORECAST REPORT, P. 74**

T 013 FINANCIAL CONTROL PARAMETERS

	2018	2017	2016	2015	2014	2013	2012
Group sales (in EUR millions)	1,084.1	1,017.1	894.9	889.6	694.7	635.5	604.6
Adjusted EBITA margin (in %) ¹	16.0	17.2	17.6	17.6	17.5	17.7	17.4
Net operating cash flow (in EUR millions)	124.4	132.9	148.5	134.7	109.2	103.9	81.0
NORMA Value Added (in EUR millions)	60.8	54.9	53.1	48.3	n/a	n/a	n/a

1_The adjustments are shown in the ► **NOTES, P. 141**

T 014 NON-FINANCIAL CONTROL PARAMETERS

	2018	2017	2016	2015	2014	2013	2012
Number of invention applications ¹	32	33	n/a	n/a	n/a	n/a	n/a
Defective parts per million (PMP) ²	7	16	32	21	17	24	34
Quality-related customer complaints per month ²	7	9	8	8	8	9	10

1_The number of invention applications has served as a key control parameter for measuring the Group's innovative ability since mid-2016, replacing the number of patent applications, a figure that had lost significance in light of changes in the patent strategy. ► **2016 ANNUAL REPORT, P. 55** Since the number of invention applications was recorded for the first time for fiscal year 2017, there are no comparative figures for the previous years.

2_The newly acquired companies in fiscal year 2018, Kimplas and Statek, are not yet included here.

GOALS REGARDING FINANCE AND LIQUIDITY MANAGEMENT

NORMA Group's objectives with respect to central finance and liquidity management have not changed since the previous year and are as follows:

I. Ensuring solvency at all times

The main financial objectives are maintaining the necessary liquidity for the Group's operating business at all times, maintaining sufficient strategic liquidity reserves and thus ensuring NORMA Group's long-term solvency.

This also includes maintaining sufficient liquid funds for short- to medium-term acquisitions.

Rolling, regular, currency-differentiated liquidity planning for all major Group companies, which is analyzed and aggregated by the centrally organized Group Treasury, forms the main strategic cornerstone of NORMA Group's financial management. Financing flexibility is ensured by maintaining the appropriate credit lines. These are negotiated loan commitments, which can be utilized within a very short period of time and thus can

37 Principles of the Group

51 Economic Report

74 Forecast Report

79 Risk and
Opportunity Report

91 Remuneration Report

98 Other Legally
Required Disclosures101 Report on Transactions
with Related Parties

compensate for liquidity peaks. NORMA Group has a so-called 'Sunshine Line' and a revolving credit line within its syndicated bank loan. These credit lines can be used in different currencies and terms. NORMA Group uses Asset Backed Securities (ABS), factoring and reverse factoring programs to manage liquidity, optimize working capital and make its cash flows more predictable.

The financing measures conducted in fiscal year 2018, are described in detail in the notes to the financial position. ► **FINANCIAL POSITION, P. 62**

II. Limiting financial risks

The Group Treasury division constantly identifies and assesses interest rate and currency risks and selects suitable hedging instruments to reduce these risks. Here, not only derivatives, but also the appropriate foreign currency financing, are used to reduce currency risks. The overall goal is to optimize the assets and liabilities side of the balance sheet with regard to currency risks. In addition, operating currency risks are reduced by using derivative financial instruments in the Group companies as of a defined threshold. Here, Group-wide, currency-differentiated liquidity planning is crucial to identifying and managing such risks.

To limit interest rate risks, NORMA Group's objective is to devise a relatively high proportion of financing measures in such a way that they are subject to interest rates on a fixed-interest basis or use interest rate swaps. On December 31, 2018, around 29% of all debt instruments had variable interest rates and were not hedged by interest rate swaps. In addition, existing risk positions are monitored regularly by Group Treasury and assessed for their risk-bearing capacity. Group Treasury initiates appropriate countermeasures if the defined risk parameters are exceeded.

Key elements of the policy on limiting financial risks are the clear definition of process responsibilities, multi-stage approval processes and regular risk assessments. These have been fixed in a Treasury Directive and are also subject to auditing. Compliance with the European Market Infrastructure Regulation (EMIR), which was certified in 2018 for the year 2017 by the auditor with no objections raised, is equally important to the audit. NORMA Group thus meets all of the prerequisites for process mapping and control with regard to the handling of financial risks.

III. Optimizing the Group's internal liquidity

NORMA Group Holding GmbH assumes central liquidity management and is responsible in particular for investing surplus liquidity as well as for intra-Group financing. The Group Treasury of NORMA Group constantly

works on improving internal financing opportunities and bundling the Group's liquidity in order to make it available for a wide variety of funding purposes. This is achieved by optimizing the allocation of cash and cash equivalents in NORMA Group Holding and at the same time ensuring that the respective individual companies are solvent at all times. This is done by using a professional treasury management system which provides a daily overview of the cash holdings of the most important subsidiaries. Regional cash pools have been installed to enable the technical implementation of liquidity centralization. Further cash concentrations are performed at regular intervals. Manually pooling funds makes it possible to guarantee an optimized cash balance for all Group companies, whereby in particular the local terms for international payments must be taken into account here.

RESEARCH AND DEVELOPMENT

Research and development activities at NORMA Group are aimed at further expanding the Group's power of innovation and detecting and addressing technological trends, such as electromobility and digitalization, as early as possible. The focus is on opening up new markets, winning new customers and developing new products and system solutions. That includes evaluating new technologies, especially in terms of their ability to optimize existing processes, minimize the use of materials and improve the functionality of end products. Research is mainly focused on finding solutions for the global industrial challenges of the respective end markets. By concentrating on the megatrends of importance to its customers, particularly reflected in increasing environmental awareness and the economical use of resources, NORMA Group is able to initiate technology developments at an early stage and serve the market by offering appropriate product solutions and services. A strategic focus is also on water management.

FOCUS ON INNOVATIONS

A clear focus of NORMA Group's R&D department is on strengthening the Company's innovative capacity. In order to identify technological trends at an early stage and systematically plan and carry out product development, new methods and innovation management processes have been implemented over the past two years by introducing 'Innovation Roadmapping' and so-called 'Innovation Scouts.'

As part of 'Innovation Roadmapping,' long-term technology development schedules are drawn up that take into account the industrial megatrends that have been identified as well as their impact on the relevant markets and resulting requirements for potential new products. So-called 'Innovation Councils' are driving the implementation of the projects identified. For example, the Innova-

INTRODUCTION

OUR VISION

TO OUR SHAREHOLDERS

**CONSOLIDATED
MANAGEMENT REPORT**

CONSOLIDATED
FINANCIAL STATEMENTS

FURTHER INFORMATION

37 Principles of the Group

51 Economic Report

74 Forecast Report

79 Risk and
Opportunity Report

91 Remuneration Report

98 Other Legally
Required Disclosures

101 Report on Transactions
with Related Parties

tion Council 'E-Mobility' is responsible for coordinating all information and global activities on electromobility, developing a strategy geared to all regions and business sectors, and pressing ahead with its implementation. Another Innovation Council is also working on the subject of digitalization. Innovation Scouts – dedicated NORMA Group employees who collect ideas on future trends across the Group and evaluate their feasibility – are intensively involved in the innovation process.

In fiscal year 2018, NORMA Group's R&D department established the position of a Foresight Manager in order to identify future areas of interest and collect and evaluate external market information. The Foresight Manager is intensively involved in monitoring new trends and developments with regard to end markets, products and technologies and contributing that knowledge to the internal innovation management process.

Furthermore, the function of the Advanced Purchasing Manager was also introduced to create an interface between Purchasing and the R&D department. The Advanced Purchasing Manager is tasked with identifying suppliers with innovative methods, materials and processes, validating them and integrating them into NORMA Group's value chain at an early stage.

INNOVATIVE THINKING IS REWARDED

NORMA Group measures the number of invention applications submitted by its employees in an effort to promote innovative thinking within the Group. An invention application takes place as part of a formalized internal process in which NORMA Group employees are given the opportunity to submit their ideas to the R&D department. The process of reporting an invention is upstream of the external process of applying for a new patent and is specifically supported by internal incentive systems such as the annual Innovation Excellence Award.

Thanks to these measures, NORMA Group expects to not only be able to focus on innovations better in the years to come, but also to increase its efficiency in the areas of product and customer development.

**STRATEGIC COLLABORATION WITH CUSTOMERS
AND RESEARCH INSTITUTES**

In the area of EJT, NORMA Group works closely with its end customers, but also with research and development institutes, suppliers and other external partners. The continued expansion of the customer network in the area of e-mobility was once again a focus in 2018. This allows for customer demands to be identified immediately and be seamlessly turned into new technologies and product ideas. This, in turn, allows for fast marketing of product innovations. For competitive reasons, however, the Company does not disclose the specific nature of these research partnerships.

As the Distribution Services division is purely a commercial unit, the market does not demand the same level of technological research from it. Moreover, customers of NORMA Group in this business division expect a strong brand image, constant availability of products, and the most complete product range. Therefore, the focus in the DS area lies on making useful additions to the product range and targeted marketing activities. ► **MARKETING, P. 72**

DEVELOPMENT FOCUSES IN 2018

Besides e-mobility, the focus of R&D activities in 2018 continued to be on the introduction of Selective Catalytic Reduction (SCR) systems for large automotive customers. These customers have to continuously optimize their systems in order to achieve the international emission targets, which will make a further reduction of nitrogen oxide emissions for diesel vehicles mandatory by 2020. NORMA Group supports several OEMs in the conceptual development of these improved systems.



37 Principles of the Group

51 Economic Report

74 Forecast Report

79 Risk and
Opportunity Report

91 Remuneration Report

98 Other Legally
Required Disclosures101 Report on Transactions
with Related Parties**KNOW-HOW PROTECTED BY PATENTS**

The Company's specific know-how in the area of joining technology represents a key success factor for NORMA Group. Therefore, the Group protects its innovations with patents. As of December 31, 2018, 1,038 patents and utility models (2017: 913) were held. In 2018, 65 new patent rights (2017: 51) were filed. The remainder includes patents already registered but not allocated until the fiscal year 2018 and patents acquired as part of acquisitions.

R&D EXPENSES

EJT research and development expenditure in 2018 amounted to EUR 30.5 million (2017: EUR 29.4 million), representing approximately 4.5% (2017: 4.6%) of

EJT revenue. The capitalization ratio, which is the proportion of own work capitalized in relation to R&D expenses, during the reporting year amounted to 11.0% (EUR 3.3 million).

R&D EMPLOYEES

As of December 31, 2018, 365 employees (2017: 344) worldwide worked for NORMA Group in the R&D department, which represents approximately 5.3% of all permanent employees of the Group (2017: 5.6%). Most of the employees who work in R&D are engineers, technicians and technical draftsmen.

T 015 R&D KEY FIGURES ¹

	2018	2017	2016	2015	2014	2013	2012	2011
Number of R&D employees	365	344	305	271	250	205	190	174
R&D employee ratio in relation to permanent staff (in %)	5.3	5.6	5.6	5.3	5.2	5.0	5.1	5.1
R&D expenses in the area of EJT (in EUR millions)	30.5	29.4	28.8	25.4	25.7	21.9	22.1	16.8
R&D ratio in relation to EJT sales (in %)	4.5	4.6	5.4	4.7	5.3	4.9	5.1	4.1

¹The multi-period overview shows the development of the most important R&D indicators since NORMA Group's IPO. No data was collected prior to the IPO.

ECONOMIC REPORT

EXTERNAL FACTORS OF INFLUENCE

ECONOMIC FACTORS

NORMA Group is active in many different industries and regions. Seasonal and economic fluctuations in individual countries or industries can have varying effects on customer demand and the order situation at NORMA Group. At the same time, NORMA Group is less vulnerable to temporary declines in demand in individual industries or countries thanks to its diversified product portfolio and broad customer base. Temporary production peaks can be absorbed due to flexible production structures and the use of temporary workers.

Global economy weakens noticeably over the course of 2018

The global economy passed its cyclical peak in 2018. The US trade conflict with China and the uncertainties surrounding the unclear Brexit process depressed the overall sentiment. In addition, the upturn in China weakened as a result of trade restrictions. In this environment, the industrial climate in the major national economies increasingly deteriorated. According to the International Monetary Fund (IMF), the global economy still grew by 3.7% in 2018 (2017: 3.8%) thanks to a strong first half of the year. The US Federal Reserve (Fed) continued its course of interest normalization, while the ECB stuck to its zero interest rate policy. However, the ECB completed its bond purchases at the end of the year as planned, however. The US dollar also appreciated to the euro in 2018.

The upturn in the Chinese economy lost momentum in 2018. According to official figures, China's economy grew by 6.6%. Besides the structural change in favor of domestic demand and high technology, the initial burdens from the trade conflict with the US had a dampening effect. Industrial production, which rose by 6.2% for the full year (2017: 6.6%), slowed down starting in the fall. The production of microcomputers, cell phones and automobiles in particular dropped so that even the respective annual production declined. At 5.2%, Southeast Asia's emerging markets (ASEAN-5) grew more slowly than before (2017: 5.3%). India returned to a more vigorous expansion course in 2018, posting an increase of 7.3%, following the reform-related setback in the previous year (+6.7%). Brazil (+1.3%) and Russia (+1.7%) recovered somewhat, while emerging and developing countries grew by a total of 4.6% (2017: 4.7%).

The US economy grew by 2.9% in 2018, according to initial official data. Driven by massive tax cuts and higher government spending, the economic upturn has gained strong momentum. Stimulus for the domestic economy came primarily from investments in equipment and private consumption. According to Fed

data, industrial production increased by 4.1% (2017: +1.6%). Final-quarter growth was also 4.1%, with high growth rates in the primary energy sector and oil production. Excluding energy, industrial production rose by 2.4%. The semiconductor industry increased its production by an above-average figure. US capacity utilization stood at 78.7% in December (Dec 2017: 77.3%), but was well below the long-term average of 79.8% (1972–2017). Japan's economy grew weakly by 0.9% (2017: 1.9%) according to the IMF, and the UK's economic growth remained weak in advance of the Brexit (2018: +1.4%). According to the IMF, established economies still grew robustly overall by 2.3% in 2018 (2017: 2.4%).

T 016 GDP GROWTH RATES (REAL)

IN %	2018	2017	2016
World ¹	+3.7	+3.8	+3.3
USA ²	+2.9	+2.2	+1.6
China ³	+6.6	+6.9	+6.7
Euro zone ⁴	+1.8	+2.4	+2.0
Germany ⁵	+1.5	+2.2	+2.2

Sources: 1_ IMF; 2_ US Trade Ministry; 3_ National Bureau of Statistics (NBS); 4_ Eurostat, 5_ German Federal Statistical Office (Destatis)

Investment remained buoyant in 2018 despite the economic slowdown in the euro zone

The buoyancy of the economy in the euro zone weakened considerably in 2018, although inflation and interest rates remained low and the euro depreciated. Growth slowed significantly to 1.8% (EU statistical office Eurostat). Besides the growing uncertainties caused by implemented and threatening new trade conflicts and the fruitless Brexit negotiations, the budget dispute between Italy and the EU and the higher debts of Italy and France had a negative impact. Private consumption remained robust, supported by wage increases and growth in employment. Investment activity was also buoyant thanks to high capacity utilization and a good order situation. All member states recorded further growth in 2018, but the EU Commission estimates that the momentum flattened out above all in large member states. In contrast, the Netherlands and Austria grew strongly. The Eastern European member countries of the monetary union and the EU also recorded high growth rates.

Industrial production in the euro zone faltered since the summer of 2018. Year-on-year production was 1.1% above the previous year's level. The IfW estimates that investments in equipment increased by 3.0% in real terms. The capacity

37 Principles of the Group

51 Economic Report

74 Forecast Report

79 Risk and
Opportunity Report

91 Remuneration Report

98 Other Legally
Required Disclosures101 Report on Transactions
with Related Parties

utilization of companies remained at a high level, but declined by 30 basis points within a year to 83.6% in the fourth quarter of 2018.

Upswing in Germany slowed since mid-year, domestic economy remains robust

The German economy noticeably lost momentum in the late phase of a boom. As a result of higher employment and incomes, private consumption and brisk corporate investment activity were the pillars of the upswing. In the second half of the year, however, production losses in the automotive industry were reflected in an economic dent. According to the Federal Statistical Office, the gross domestic product grew by only 1.5% in 2018 as a whole after 2.2% in each of the two previous years. Private consumption rose by 1.0% in real terms (2017: 1.8%) and made a significant contribution to growth at 50 basis points. Investments in equipment (+4.5%) and construction (+3.0%) were very dynamic, so that they also made important contributions to growth. By contrast, export growth flattened out sharply. In contrast to the previous year, net exports burdened GDP growth by –0.2 percentage points.

Industrial production was still very lively in the first half of 2018, with annual growth rates of 2% to 5% per month. Since the middle of the year, however, the growth rates have only reached a maximum of +0.9% (July) and even losses of up to –5.1% (November). According to Eurostat data, industrial capacity utilization fell to 87.1% in the fourth quarter (Q4 2017: 87.7%).

Currency rate effects

Due to NORMA Group's international activities, exchange rate fluctuations also influence its business. While fluctuations between non-euro currencies have only little impact on the operating result of NORMA Group as a result of regional production, exchange rate fluctuations against the euro as the reporting currency may have a greater impact on its results. Due to the high US dollar exposure, fluctuations in the EUR/USD exchange rate in particular affect earnings. ► **RISK AND OPPORTUNITY REPORT, P. 79** In fiscal year 2018, NORMA Group generated more than 40% of its sales in US dollars. The development of the US dollar against the euro resulted in a negative sales effect in fiscal year 2018. Furthermore changes in the exchange rates of the following currencies had a negative effect on the development of sales: British pound, Swedish krona, Swiss franc, Russian rubel, Turkish lira, Chinese renminbi, Japanese yen and Australian dollar.

INDUSTRY-SPECIFIC FACTORS

International mechanical engineering posts more moderate growth, while China comes to a complete stop

Although global mechanical engineering continued to grow in 2018, growth was slower than in previous years due to the economic slowdown and the US trade conflict with China. According to the industry association VDMA, global mechanical engineering sales rose by 3% in real terms in 2018 (2017: +6%). China accounted for about one third of the world's sales, although its estimated growth slumped to 2% (2017: 8%). Excluding China, the global market grew by 4%. High growth rates were achieved in Singapore (+16%) and India (+10%), among other countries. In the individual ASEAN-5 countries, sales increased by 7% to 12%. In Japan, however, growth dropped by half to 4%, while South Korea stagnated. Sales in the US rose by 5%.

Due to brisk investment activity in Europe, the mechanical engineering sector continued its robust upswing. High growth was achieved in Switzerland, the Netherlands, Austria, Scandinavia and the EU countries of Eastern Europe. Sales also rose in Russia and Turkey. According to VDMA estimates, sales in the euro zone and the EU each increased by 4%. The German mechanical and plant engineering industry grew at an accelerated pace with high capacity utilization (October: 90.5%). In the first nine months, imports increased by 5.6% in real terms, outpacing exports (+4.0% in real terms). In 2018, production increased by a mere 2% in real terms due to a weak year-end. The VDMA forecast of +5% was thus missed. In some cases, capacity bottlenecks prevented a more positive development. Despite the high prior-year basis, the order situation continued to improve. In 2018, order intake was 5% higher in real terms than in the previous year. Impulses came from Germany and abroad, whereby the increase was stronger within the euro zone than from non-euro countries. Domestic orders even rose by 6%.

Automotive industry: Passenger car market stagnated, commercial vehicles worldwide with growth

For the first time since 2009, the automotive industry did not experience growth. Besides the uncertainties regarding exhaust emissions and driving bans, the economic slowdown and US restrictions on trade with China had a negative impact. According to LMC Automotive (LMCA), global sales of light vehicles (LV, up to 6 t) fell slightly to 95.1 million LV (–0.2%). Worldwide, LV production was 0.5% lower. According to the VDA, the more narrowly defined global passenger car market stagnated at a sales volume of 85 million passenger cars. By contrast, global truck production and sales each increased by 3.7% (LMCA). According to LMCA data, regional developments varied greatly. China suffered from purchasing restraint as a result of planned new emission standards and the trade conflict. LV sales and production fell by 2.2% and 3.5%, respectively, while truck

37 Principles of the Group

51 Economic Report

74 Forecast Report

79 Risk and
Opportunity Report

91 Remuneration Report

98 Other Legally
Required Disclosures101 Report on Transactions
with Related Parties

production shrank by 8.4%. The LV market in the US stagnated (unit sales: +0.3%, production: +0.1%), while truck production and unit sales grew at double-digit rates. Mexico increased its truck production by 28.5%. While Japan's LV market moved sideways, robust growth continued in India. Both countries significantly increased their truck production.

In Europe, sales stagnated at 15.6 million passenger cars (EU28 + EFTA), according to the ACEA association. Sales in Eastern Europe rose by 8.0%, but sales in Western Europe fell by 0.8%. While more passenger cars were sold in Spain and France, sales declined in Italy and the United Kingdom. Germany fell just short of the previous year's level (-0.2%). According to LMCA data, production in Europe remained stable at 22.2 million LV (+0.2%). The negative factors were subdued demand, lower imports to Turkey and China, and production losses due to the switch to the WLTP procedure. German manufacturers in particular suffered as a result with production losses of 6.4%. British LV production also declined noticeably by 6.8%.

The European commercial vehicle market grew moderately. Truck production increased by 2.3% in 2018 (LMCA). According to ACEA data, sales of buses and trucks of all weight classes in Europe rose by 3.1% in total to nearly 2.6 million commercial vehicles (West: +2.4%, East: +9.7%). Spain's 6.5% growth was stronger than in the other volume markets. In France (+4.9%) and Germany (+4.6%), sales of commercial vehicles rose robustly, while sales volumes fell in Italy (-4.1%) and Great Britain (-1.9%). All commercial vehicle segments grew in 2018, the three truck segments by a good 3% each. Bus sales rose at a disproportionately low rate of 0.7%.

Europe's construction industry on the upswing, residential construction and civil engineering with strong tailwind

The European construction industry continued its upswing in 2018. According to the Euroconstruct industry network (including the ifo Institute), construction output in the 19 core markets increased by 2.8% (2017: +4.1%). This was driven by low interest rates, population growth, urbanization and a high level of public willingness to invest, especially in transport infrastructure. Civil engineering provided the greatest impetus with real growth of 5%. Residential construction, which accounts for almost half of European construction output with conversions and modernization, continued its upswing by posting an increase of just under 3%. The new construction segment boomed (+8.8%). Construction output in this sector rose by 2.2% in real terms in Western Europe (2017: +3.9%) with growth in all countries except the UK. Eastern Europe even achieved real growth of 13.4% (2017: +9.3%).

Construction spending in Germany in 2018 grew by 3.0% in real terms (2017: +2.9%), according to Destatis. According to the IfW, this growth was based on brisk construction activity in residential and public construction. The German Institute for Economic Research (DIW) estimates that the total volume of housing construction grew by 8.6% to EUR 230 billion in nominal terms (2017: +6.3%). Construction work on existing buildings (extensions/conversions, modernization, maintenance), which constitutes two thirds of the construction volume of apartments, increased by 7.9% (2017: +7.1%). In other building construction (excluding housing), the construction volume rose by 6.2% (2017: +4.5%) and in civil engineering by 8.7% (2017: +7.1%), with public civil engineering achieving nominal growth of 11.6%.

LEGAL AND REGULATORY INFLUENCING ASPECTS

Due to the international focus of the business and against the backdrop of its acquisition strategy, various legal and tax-related regulations are of relevance to NORMA Group. Among others, these include product safety and product liability laws, construction, environmental and employment-related regulations as well as foreign trade and patent laws. ► **RISK AND OPPORTUNITY REPORT, P. 79**

In addition, NORMA Group's product strategy is influenced by the increasing density of regulations in environmental law and the current discussion on alternative drive technologies in the automotive industry. In particular, new emission regulations and the country-specific fleet regulations for passenger cars have positive effects on NORMA Group's business. After all, the increasing complexity of systems in vehicles also increases the number of potential interfaces and thus the demand for reliable and innovative joining technology. The trend towards hybrid drive models that can currently be observed is also accompanied by an increase in complexity because additional systems are needed in addition to the combustion engine, in the area of thermal management, for example. This also plays a decisive role in pure electric vehicles. Thermal management encompasses both the cooling and the heating of the battery used for the additional generation of energy in order to bring it into an optimal operating state. In this area too, NORMA Group sees additional potential for its product portfolio in the short to medium term.

With the acquisition of National Diversified Sales (NDS) in 2014 and the more recent acquisition of the Indian water company Kimplas, the various regulatory initiatives in the field of water management as well as public measures to improve the supply of water to the population have also gained considerable influence for NORMA Group.

37 Principles of the Group

51 Economic Report

74 Forecast Report

79 Risk and
Opportunity Report

91 Remuneration Report

98 Other Legally
Required Disclosures101 Report on Transactions
with Related Parties**SIGNIFICANT DEVELOPMENTS IN FISCAL YEAR 2018****STRATEGIC COMPANY ACQUISITIONS****Acquisition of Kimplas Piping Systems Ltd.**

In April 2018, NORMA Group announced the acquisition of the Indian water company Kimplas Piping Systems Ltd. ('Kimplas'). The acquisition of 100% of the shares in the company was successfully completed on July 5, 2018. Consolidation took place from this point in time.

Based in Nashik, Maharashtra State, West India, Kimplas has been developing and producing joining solutions for safe and leakage-free drinking water and gas supply in rural and urban regions of India since 1996. Kimplas's product portfolio includes compression fittings, sprinklers and droppers, valves, filters and electrofusion fittings for gas and water pipes. The company also sells plastic pipes and imported nozzles as well as machines and tools for electrofusion fittings. Kimplas's customers include exporters, water boards, domestic and foreign gas suppliers, micro irrigation system suppliers and construction companies. Kimplas sells most of its products in India. The company that employs more than 600 people generated sales of around EUR 21 million in fiscal year 2018 (April 2017 to March 2018).

Successful completion of the acquisition of Statek Stanzertechnik GmbH

At the beginning of August 2018, NORMA Group successfully completed the acquisition of its supplier Statek Stanzertechnik GmbH ('Statek'), following approval by the antitrust authorities. The company based in Maintal was founded in 1980 and manufactures contact and stamped parts, housings and wave springs. The company has around 60 employees and supplies well-known German and international customers in the electrical engineering, automotive and reactor technology sectors. NORMA Group had a long-standing business relationship with Statek and obtains its housings and corrugated springs for worm drive clamps from the medium-sized company. Statek generated sales revenues of around EUR 17.2 million in fiscal year 2017, around 70% thereof with NORMA Group as its main customer. Initial consolidation took place on August 1, 2018. ► **ACQUISITIONS AND CHANGES OF LEGAL STRUCTURE, P. 37**

PLANT OPENING IN MEXICO

In November 2018, NORMA Group opened a new plant in Tijuana, Mexico, thereby expanding its capacities in the Americas region. By opening this new plant, NORMA Group is taking its growth and profitability targets for the coming years into account. The flow management products from the subsidiary National Diversified Sales (NDS), which were previously manufactured in Lindsay, California, have been produced at the new 140,000 m² production facility in Tijuana since November.

COMPARISON OF TARGET AND ACTUAL VALUES

NORMA Group published a forecast in its 2017 Annual Report on the development of the Group's most important financial figures in fiscal year 2018. In the course of the fiscal year under review, the Management Board was forced to adjust its forecast for Group sales growth, the adjusted EBITA margin and the net operating cash flow due to changes in the general conditions. The explanations below provide an overview of the forecast adjustments and a comparison of the projected values with the Group's actual results.

ADJUSTMENTS TO THE FORECAST DURING THE YEAR

NORMA Group's Management Board raised the sales forecast for the Group in May 2018 on the basis of sales revenues for the period from January to April 2018 and the expected sales performance in the second half of the year. Instead of organic Group sales growth of around 3% to 5%, the Management Board since then expected Group sales growth of around 5% to 8% for the full year 2018. The forecast adjustment is partly the result of better-than-expected developments in the Americas and Asia-Pacific regions, which is why the Management Board raised its forecast for organic sales growth in both regions. The main factors behind this development were the significant recovery of the commercial vehicle and agricultural machinery markets and a water business in the US that was strengthened by catch-up effects. In the Asia-Pacific region, strong demand for joining products in China in particular had a more significant impact on sales than expected.

In July 2018, NORMA Group's Management Board revised its forecast for the adjusted EBITA margin and net operating cash flow downwards on the basis of the expected figures for the second quarter and the expected development in the second half of the year. The main reasons for this were significant price increases for important raw materials, especially in the area of alloy surcharges, force majeure for important plastic components and increased trade barriers, due to US tariffs on steel, for example. In addition, the increasing shortage of materials on the raw material markets and the strong sales growth temporarily led to variable special costs in the areas of purchasing, production and logistics. Based on this, the Management Board therefore reduced its forecast for the adjusted EBITA margin to between 16% and 17% (previously: sustainable at the same level as in previous years of more than 17%) and the forecast for net operating cash flow to around EUR 130 million (previously: around EUR 140 million). The Management Board maintained its forecast for organic growth, aiming for the upper end of the range of around 5% to 8%.

INTRODUCTION

OUR VISION

TO OUR SHAREHOLDERS

**CONSOLIDATED
MANAGEMENT REPORT**

CONSOLIDATED
FINANCIAL STATEMENTS

FURTHER INFORMATION

37 Principles of the Group

51 Economic Report

74 Forecast Report

79 Risk and
Opportunity Report

91 Remuneration Report

98 Other Legally
Required Disclosures

101 Report on Transactions
with Related Parties

The forecast for the remaining target values remained unchanged. The ► **TABLE 017 ON P. 56** provides an overview of the target and actual values as well as the forecast adjustments during the year.

DEVIATIONS FROM THE TARGET VALUES

NORMA Group achieved the organic growth in Group sales that had been revised upwards for fiscal year 2018 in May. At 7.7%, this figure is at the upper end of the 5% to 8% range, as forecast.

With respect to costs on the other hand, the development was divergent. While the adjusted cost of materials ratio and other operating income and expenses as a percentage of sales rose year-on-year as a result of the tense situation on the raw materials markets and the resulting inefficiencies in NORMA Group's production processes, the adjusted personnel cost ratio was lower mainly due to lower allocations to employee bonuses and the reversal of personnel-related provisions. This resulted in an adjusted EBITA margin of 16.0%, which was within the range, but at the lower end of the 16% to 17% range adjusted in July 2018.

Net operating cash flow amounted to EUR 124.4 million in fiscal year 2018 and was thus slightly below the forecast of around EUR 130 million adjusted in July 2018.

The other key financial figures were in line with the forecast published in the 2017 Annual Report.

GENERAL STATEMENT BY THE MANAGEMENT BOARD ON THE COURSE OF BUSINESS AND ECONOMIC SITUATION

NORMA Group ended fiscal year 2018 by achieving organic growth of 7.7%, the second consecutive year of strong organic growth. This growth was driven by the significant recovery of the US commercial vehicle and agricultural machinery markets, a resurgent US water business and strong demand for high-quality joining solutions from China in the first half of 2018. The integration of Kimplas and Statek, the companies acquired in the second half of the year, also proceeded according to plan. Together with Fengfan, which was acquired in 2017, the companies contributed a total of EUR 16.5 million to (acquisition-related) sales in fiscal year 2018.

With an adjusted result for the period of EUR 114.8 million, an increase of 9.3% over the previous year, and adjusted earnings per share of EUR 3.61, fiscal year 2018 was a good year despite all the challenges in which important foundations for further growth were laid.

Nevertheless, the Management Board is cautious about the current year due to declining global growth dynamics, industry-specific challenges, especially in the European and Chinese automotive sectors, and geopolitical uncertainties regarding the outcome of the Brexit negotiations. Against this backdrop and the high growth levels of NORMA Group over the past two years, the Management Board anticipates a lower growth intensity for the Group in the current year 2019. ► **FORECAST REPORT, P. 74**

37 Principles of the Group

51 Economic Report

74 Forecast Report

79 Risk and
Opportunity Report

91 Remuneration Report

98 Other Legally
Required Disclosures101 Report on Transactions
with Related Parties**T017 ACTUAL BUSINESS DEVELOPMENT COMPARED TO THE FORECAST**

	Results in 2017 ¹	March 2018	May 2018	July 2018	Results in 2018 ¹
Group sales	EUR 1.017,1 million	n/a	n/a	n/a	EUR 1,084.1 million
Organic growth of Group sales	8.6% organic growth, additionally EUR 57.3 million from acquisitions	solid organic growth of around 3% to 5%, additionally around EUR 5 million from acquisitions	solid organic growth of around 5% to 8%, additionally around EUR 5 million from acquisitions	solid organic growth of around 5% to 8%, whereas the upper end of the range is targeted, additionally around EUR 17 million from acquisitions	7.7% organic growth, additionally EUR 16.5 million from acquisitions
Organic sales growth EMEA	6.2%	solid organic growth	no adjustment	no adjustment	2.0%
Organic sales growth Americas	8.4%	solid organic growth	strong organic growth	no adjustment	12.4%
Organic sales growth Asia-Pacific	22.7%	organic growth in the double-digit range	higher than originally expected organic growth in the double-digit range	no adjustment	14.9%
Sales growth EJT	19.1%	solid growth	strong growth	no adjustment	7.3%
Sales growth DS	5.0%	solid growth	no adjustment	no adjustment	5.8%
Adjusted cost of materials ratio	41.2%	roughly at the same level as in previous years	no adjustment	no adjustment	43.6%
Adjusted personnel expense ratio	26.5%	roughly at the same level as in previous years	no adjustment	no adjustment	25.9%
Adjusted EBITA margin	17.2%	sustainable at the same level as in previous years of more than 17.0%	no adjustment	between 16% and 17%	16.0%
Financial result	EUR – 16.1 million	up to EUR – 15.0 million	no adjustment	no adjustment	EUR – 11.7 million
Adjusted tax ratio	30.0%	around 26% to 28%	no adjustment	no adjustment	24.9%
Earnings per share	EUR 3.29 (adjusted) EUR 3.76 (reported)	strong increase	no adjustment	no adjustment	EUR 3.61 (adjusted) EUR 2.88 (reported)
Net operating cash flow	EUR 132.9 million	around EUR 140 million	no adjustment	around EUR 130 million	EUR 124.4 million
Investments in R&D (related to EJT sales)	4.6%	around 5% of EJT sales	no adjustment	no adjustment	4.5%
Investment rate (without acquisitions)	4.7%	operational investments of around 5% of Group sales	no adjustment	no adjustment	5.8%
Dividend Payout ratio	EUR 1.05 31.9%	approx. 30% to 35% of adjusted annual Group earnings	no adjustment	no adjustment	EUR 1.10 ² 30.5%
Number of invention applications	33	more than 20	no adjustment	no adjustment	32
Number of defective parts per million (PMP)	16	less than 20	no adjustment	no adjustment	7
Average number of quality-related customer complaints per month	9	less than 8	no adjustment	no adjustment	7

1_The adjustments relate to adjustments for acquisitions as well as the initiated rightsizing project announced in February 2019. ► **NOTES, P. 141**

2_in accordance with the Management Board's proposal for the appropriation of net profit, subject to the approval by the Annual General Meeting on May 21, 2019.



37 Principles of the Group

51 Economic Report

74 Forecast Report

79 Risk and
Opportunity Report

91 Remuneration Report

98 Other Legally
Required Disclosures101 Report on Transactions
with Related Parties

EARNINGS, ASSETS AND FINANCIAL POSITION

ADJUSTMENTS

NORMA Group adjusts certain expenses for the operational management of the Company. The following adjusted results shown reflect the management's view.

In fiscal year 2018, net expenses of EUR 4.4 million in total were adjusted within EBITDA (2017: EUR 3.5 million). These relate to the cost of materials (2018: EUR 0.4 million; 2017: EUR 1.1 million) resulting from the valuation of the acquired inventories as part of the purchase price allocation for the Kimplas acquisition. Furthermore, expenses for acquisition-related costs in connection with the acquisition of Kimplas and Statek in the amount of EUR 1.2 million were adjusted within other operating expenses. Moreover, expenses for the integration of the two companies (2018: EUR 0.4 million; 2017: EUR 2.2 million) were adjusted within other operating expenses and within employee benefits (2018: EUR 0.2 million; 2017: EUR 0.6 million).

In addition, adjustments of EUR 2.2 million in total were made in connection with the rightsizing project initiated in the fourth quarter of 2018 to optimize the Group's structures. The adjustments within expenses for employee benefits relate to costs for project hours of internal employees of the core workforce (EUR 1.0 million), costs for project employees hired temporarily (EUR 0.6 million) and costs for severance payments made (EUR 0.1 million). Furthermore, costs within other operating expenses amounting to EUR 0.4 million and costs within cost of materials amounting to EUR 19 thousand were also adjusted.

In addition to the adjustments described above, depreciation on property, plant and equipment from purchase price allocations of EUR 3.9 million (2017: EUR 4.2 million) was shown as adjusted within EBITA in fiscal year 2018 as in previous years, and amortization of intangible assets from purchase price allocations of EUR 21.1 million (2017: EUR 20.5 million) was shown as adjusted within EBIT.

Furthermore, an impairment loss of EUR 1.4 in the area of capitalized customer relationships was adjusted in fiscal year 2018 within amortization of intangible assets. This related to the Chinese company Fengfan.

Notional income taxes resulting from the adjustments are calculated using the tax rates of the respective local companies concerned and included in adjusted earnings after taxes.

The following table shows the result adjusted for these effects:

T 018 ADJUSTMENTS ¹

IN EUR MILLIONS	2018 adjusted	Adjustments	2018 reported
Group sales	1,084.1	0	1,084.1
EBITDA	201.4	4.4	197.0
EBITDA margin (in %)	18.6		18.2
EBITA	173.2	8.4	164.8
EBITA margin (in %)	16.0		15.2
EBIT	164.5	30.9	133.5
Financial income	-11.7	0	-11.7
Profit for the period	114.8	23.0	91.8
EPS (in EUR)	3.61	0.73	2.88

¹ Deviations may occur due to commercial rounding.

EARNINGS POSITION

The development described below describes the changes in the main items of the income statement in the year under review, adjusted for the above-mentioned special effects. ► **NOTES, P. 141**

Sales development

Strong growth in Group sales, additional sales revenue from acquisitions

In fiscal year 2018, Group sales of NORMA Group increased by 6.6% to EUR 1,084.1 million (2017: EUR 1,017.1 million). This figure includes organic sales growth of 7.7% (2017: 8.6%) and acquisition-related growth of 1.6% (2017: 6.4%). Currency effects in connection with exchange rate changes had a negative effect of -2.8% (2017: -1.4%).

The main growth drivers in fiscal year 2018 were the good development of global passenger car production, the significant recovery of the US markets for commercial vehicles and agricultural machinery, the strong water business in the US and high demand for high-quality joining solutions in China, particularly in the first half of the year. In addition, Kimplas and Statek, the companies acquired in fiscal year 2018, and the Chinese company Fengfan acquired in 2017 contributed positively to sales growth.

The growth intensity varied over the year: While organic sales growth in the first half of the year was 11.0%, driven by strong demand and good production figures in the automotive industry, it leveled off significantly in the course of the third and fourth quarters. The main reasons for this were the deteriorating mood

in the European automotive sector as a result of the WLTP issue and the decline in demand in China.

T 019 EFFECTS ON GROUP SALES

	in EUR millions	Share in %
Group sales 2017	1,017.1	
Organic growth	78.6	7.7
Acquisitions	16.5	1.6
Currency effects	-28.1	-2.8
Group sales 2018	1,084.1	6.6

Heterogeneous growth in the three regional segments

NORMA Group recorded sales growth in all three regions compared with the previous year, albeit with varying intensity. The strongest growth was once again recorded in the Asia-Pacific region, where sales rose by 23.2% to EUR 147.8 million (2017: EUR 119.9 million) due to strong demand for joining technology, particularly in the Chinese automotive market. The Americas region also achieved significant growth of 7.4% year-on-year by posting sales of EUR 441.5 million (2017: EUR 411.3 million). This was driven in particular by strong demand in the commercial vehicle and agricultural machinery sectors and a strong NDS water business influenced by catch-up effects. Sales in the EMEA region amounted to EUR 494.8 million in fiscal year 2018, representing growth of 1.8% compared with the previous year (2017: EUR 485.9 million). In particular, the worsening WLTP situation in the second half of 2018 had a negative impact on production figures and correspondingly on demand in the automotive sector.

Growth in both sales divisions

Sales in the EJT segment amounted to EUR 684.6 million in fiscal year (2017: EUR 638.2 million) and were thus 7.3% higher than the year before. The reason for this was the high demand for reliable joining solutions, which was positively influenced by good production figures in the automotive industry, especially in the first half of 2018. Other important growth drivers for the EJT business are the ever stricter international emission standards and the increasing demands on the complexity and durability of the individual components in the vehicle. Sales growth in this area was dampened by the effects of the WLTP issue in Europe, which became noticeable from the third quarter onwards, and by a significant drop in demand on the Chinese automotive market.

Distribution Services revenues amounted to EUR 393.8 million in 2018, an increase of 5.8% over the previous year (2017: EUR 372.3 million). The strong US water business and Kimplas, acquired in August 2018, contributed significantly to DS growth in fiscal year 2018.

G 012 DEVELOPMENT OF SALES 2018

IN EUR MILLIONS

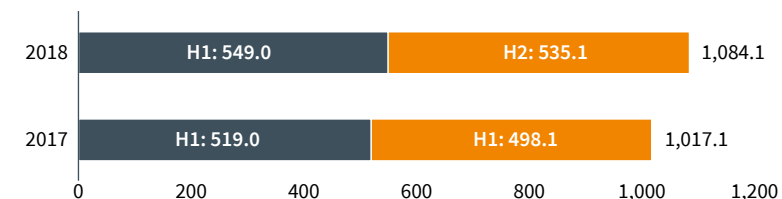

T 020 DEVELOPMENT OF SALES CHANNELS

	EJT		DS	
	2018	2017	2018	2017
Group sales (in EUR millions)	684.6	638.2	393.8	372.3
Growth (in %)	7.3	19.1	5.8	5.0
Share of sales (in %)	63	63	37	37

Development of earnings

Adjusted material cost ratio burdened by price increases on the commodity markets

A volatile environment on the global commodity markets and price increases for key raw materials of NORMA Group, particularly in the areas of steel, alloy surcharges and engineering plastics (► **PURCHASING AND SUPPLIER MANAGEMENT, P. 67**), led to a 13.0% year-on-year increase in the adjusted cost of materials to EUR 473.1 million in fiscal year 2018 (2017: EUR 418.6 million).

In addition, inventories of finished goods and work in progress increased by EUR 10.4 million compared with the previous year. Among other factors, this was a consequence of the shortages on the commodity markets, which resulted in a safety-related build-up of reserves, especially in the third quarter of 2018. Although the inventory was reduced again in the fourth quarter, it was clearly above the level of the previous year at the end of the year.

As a result of these developments, the adjusted cost of materials ratio (cost of materials in relation to sales) increased to 43.6% in fiscal year 2018 (2017: 41.2%).

37 Principles of the Group

51 Economic Report

74 Forecast Report

79 Risk and
Opportunity Report

91 Remuneration Report

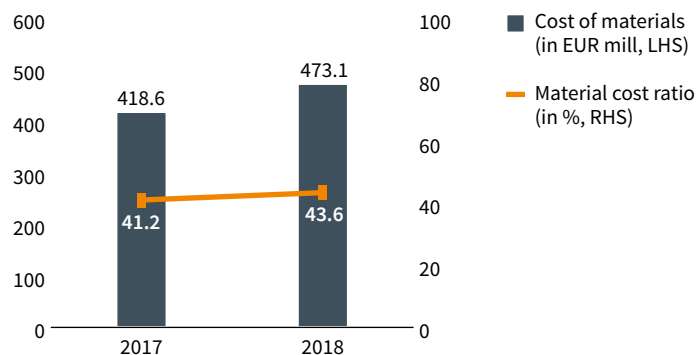
98 Other Legally
Required Disclosures101 Report on Transactions
with Related Parties**G 013 COST OF MATERIALS AND COST OF MATERIALS RATIO
(ADJUSTED)****Adjusted gross margin influenced by higher
cost of materials and inventory buildup**

Adjusted gross profit amounted to EUR 626.6 million in fiscal year 2018 (2017: EUR 601.3 million), an increase of 4.2%. At 57.8%, the adjusted gross margin was 130 basis points below the level of the previous year (2017: 59.1%). This was due to the high cost pressure on the materials side described above and the higher inventory build-up from the third quarter onwards resulting from the shortage of materials.

Lower adjusted personnel cost ratio

Adjusted personnel expenses amounted to EUR 280.8 million in fiscal year 2018, a 4.2% increase over the previous year (2017: EUR 269.6 million). This increase can be attributed to the acquisition- and growth-related increase in the average number of employees in the fiscal year. ► **EMPLOYEES, P. 69** The adjusted personnel cost ratio resulting from the ratio of adjusted personnel expenses and sales amounted to 25.9% in fiscal year 2018 and was thus 60 basis points lower compared with the previous year (2017: 26.5%). This was due in particular to lower allocations to provisions for bonus payments for employees.

**Adjusted other operating income and expenses
burdened by special variable costs**

The balance of adjusted other operating income and expenses amounted to EUR – 144.4 million in fiscal year 2018, representing an increase of 9.4% over the previous year (2017: EUR – 132.0 million). Other operating income includes in particular currency gains from operating activities of EUR 7.6 million (2017: EUR 5.6 million) as well as income from the release of liabilities and unused provisions in connection with employee-related obligations.

Other operating expenses include currency losses from operating activities of EUR 8.5 million (2017: EUR 7.8 million). In addition, freight costs in particular (+ 19.5%) increased compared to the previous year. This was mainly due to the shortage of materials on the international commodity markets and the resulting delays in NORMA Group's production processes, some of which necessitated special freight charges.

In relation to sales, the balance of adjusted other operating income and expenses rose slightly year-on-year to 13.3% (2017: 13.0%). ► **OPERATING INCOME** and ► **OPERATING EXPENSES, P. 145**

Operating result burdened by material prices and special costs

The higher cost of materials ratio and higher variable special costs in connection with a highly volatile environment on the commodities markets had a negative impact on NORMA Group's adjusted operating earnings before interest, taxes, depreciation and amortization (adjusted EBITDA), which rose slightly by 0.8% to EUR 201.4 million in fiscal year 2018 (2017: EUR 199.7 million). The adjusted EBITDA margin resulting from the ratio to sales amounted to 18.6% (2017: 19.6%) and is thus 100 basis points below the level of the previous year.

Adjusted EBITA amounted to EUR 173.2 million in 2018, a decrease of 0.8% compared to the previous year (2017: EUR 174.5 million). The resulting adjusted EBITA margin was 16.0% (17.2%) due to the developments described above and was thus below its target value of above 17.0% for the first time since the IPO.

37 Principles of the Group

51 Economic Report

74 Forecast Report

79 Risk and
Opportunity Report

91 Remuneration Report

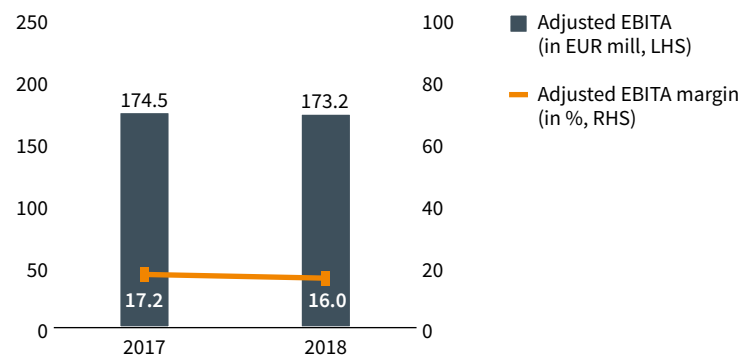
98 Other Legally
Required Disclosures101 Report on Transactions
with Related Parties**G 014 ADJUSTED EBITA AND ADJUSTED EBITA MARGIN****Return on capital employed (ROCE)**

The return on capital employed (ROCE), which is calculated by dividing adjusted EBIT by the average capital employed during the year amounted to 17.5% in fiscal year 2018 and thus decreased compared with the previous year (2017: 18.9%).

T 021 RETURN ON CAPITAL EMPLOYED (ROCE)

IN EUR MILLIONS	2018	2017
Adjusted EBIT	164.5	166.0
Average capital employed	941.0	878.5
	17.5%	18.9%

NORMA Value Added

NORMA Value Added (NOVA), the relevant benchmark for the long-term remuneration of the Management Board, amounted to EUR 60.8 million in fiscal year 2018, an improvement on the previous year (2017: EUR 54.8 million). The calculation of NOVA is based on a weighted average cost of capital (WACC) of 7.1% in fiscal year 2018 (2017: 7.0%). ► **CONTROL SYSTEM AND CONTROL PARAMETERS, P. 45**

Financial result

The financial result amounted to EUR – 11.7 million in fiscal year 2018 (2017: EUR – 16.1 million). Net currency gains/losses (including income/expenses from the measurement of currency hedging derivatives) amounted to EUR 0.7 million in 2018 (2017: EUR – 5.9 million). At EUR 13.3 million, net interest expense

decreased by EUR 0.4 million compared to the prior-year period (2017: EUR – 13.7 million). In addition, the financial result included expenses from the valuation of derivatives in the amount of EUR 0.4 million (2017: income of EUR 4.6 million). ► **NOTES, P. 146**

Revised and adjusted income taxes

Revised income taxes amounted to EUR 38.0 million in fiscal year 2018 (2017: EUR 44.9 million). This results in a revised and adjusted tax rate of 24.9% (2017: 30.0%). The lower tax rate is mainly due to the reduction in the US corporate tax rate in 2017.

Adjusted profit for the period increased

Adjusted profit for the period after taxes amounted to EUR 114.8 million in fiscal year 2018 and thus increased by 9.3% compared to the previous year (2017: EUR 105.0 million). Based on an unchanged number of shares of 31,862,400 compared to the previous year, adjusted earnings per share after deduction of the profit for the period for non-controlling interests amounted to EUR 3.61 (2017: EUR 3.29).

ASSET POSITION**Rise in total assets**

Total assets as of December 31, 2018, amounted to EUR 1,471.7 million and were therefore 12.2% higher compared to the previous year (Dec 31, 2017: EUR 1,312.0 million).

Assets impacted by acquisitions and currency effects

NORMA Group's non-current assets amounted to EUR 928.3 million as of December 31, 2018, up 12.5% on the previous year (Dec 31, 2017: EUR 825.5 million). Changes in non-current assets were impacted by the acquisitions of the two companies Kimplas and Statek and currency effects, particularly in relation to the US dollar. Non-current assets accounted for 63.1% of total assets as of the balance sheet date (Dec 31, 2017: 62.9%). ► **NOTES, P. 151**

Current assets amounted to EUR 543.4 million as of the balance sheet date, up 11.7% on the previous year (Dec 31, 2017: EUR 486.6 million). The increase is mainly due to the increase in inventories of EUR 26.9 million and a EUR 35.1 million increase in cash and cash equivalents. Cash and cash equivalents amounted to EUR 190.4 million as of December 31, 2018 (Dec 31, 2017: EUR 155.3 million). The share of non-current assets to total assets amounted to 36.9% (Dec 31, 2017: 37.1%).

- 37 Principles of the Group
- 51 Economic Report**
- 74 Forecast Report
- 79 Risk and Opportunity Report
- 91 Remuneration Report
- 98 Other Legally Required Disclosures
- 101 Report on Transactions with Related Parties

Working Capital

(Trade) working capital (inventories plus receivables less liabilities, both primarily from trade payables and trade receivables) amounted to EUR 179.2 million as of December 31, 2018, which was 13.3% higher than in the previous year (Dec 31, 2017: EUR 158.2 million). This was mainly influenced by a disproportionately high increase in inventories, which mainly resulted from the safety-related build-up of reserves in the course of the challenges on the purchasing side in fiscal year 2018. In contrast, trade and other receivables decreased. NORMA Group participates in a factoring, a reverse factoring and an Asset Backed Securities (ABS) program.

The working capital ratio in relation to sales was 16.5% as of December 31, 2018 (Dec 31, 2017: 15.6%).

Increased equity ratio

Consolidated equity amounted to EUR 602.4 million as of December 31, 2018, an increase of 12.7% compared to the previous year (2017: EUR 534.3 million). The increase in equity was largely due to the result for the period of EUR 91.8 million, but also positive currency translation differences of EUR 10.1 million. The dividend payment of EUR 33.5 million in the second quarter of 2018 reduced equity. At the end of fiscal year 2018, the equity ratio was 40.9%, nearly the same as in the previous year (2017: 40.7%).

Higher net debt

Net debt (financial liabilities, including derivative hedging instruments in the amount of EUR 0.8 million, less cash and cash equivalents) amounted to EUR 400.3 million at the end of the reporting period and thus rose by 16.1% compared to the previous year (Dec 31, 2017: EUR 344.9 million).

Financial liabilities amounted to EUR 590.7 million as of the balance sheet date and thus rose by 18.1% compared to the previous year (Dec 31, 2017: EUR 500.2 million). The increase in loans is mainly due to having made use of the accordion facility in the amount of EUR 102 million to finance the two acquisitions made in fiscal year 2018.

The increase in other financial liabilities excluding leasing by EUR 10.5 million to EUR 20.8 million (2017: EUR 10.4 million) is mainly the result of liabilities from the ABS and factoring programs.

Gearing (net debt in relation to equity) was 0.7 and thus slightly higher than last year due to higher net debt (2017: 0.6). Leverage (net debt excluding hedging derivatives in relation to the adjusted EBITDA of the last twelve months) rose to 1.9 compared to the previous year (Dec 31, 2017: 1.7).

G 015 ASSET AND CAPITAL STRUCTURE

IN EUR MILLIONS

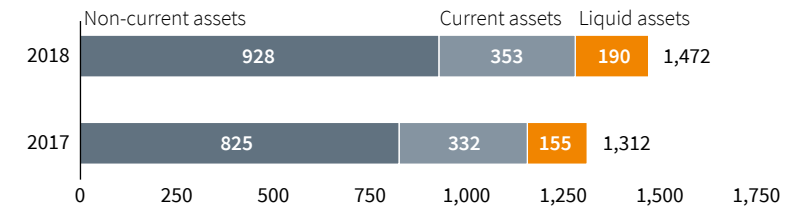
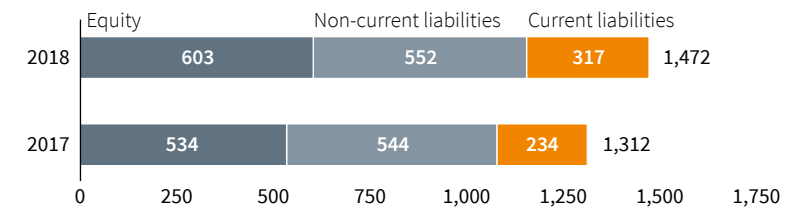
Assets**Liabilities****Non-current and current liabilities**

Non-current liabilities increased slightly by 1.5% to EUR 552.1 million (Dec 31, 2017: EUR 544.0 million) and amounted to 37.5% of total assets as of the balance sheet date (31 Dec 2017: 41.5%). Non-current loan liabilities remained virtually constant. The partial reclassification of the promissory note loan according to its maturity was compensated for the utilization of the accordion facility in fiscal year 2018. The deferred income tax liabilities increased by EUR 12.6 million (20.7%).

Current liabilities increased by 35.7% to EUR 317.1 million in 2018 (Dec 31, 2017: EUR 233.8 million) due to the above mentioned reclassification. The share of the balance sheet total amounted to 21.6% (2017: 17.8%).

Unrecognized intangible assets

NORMA Group's rights to its brands and patents on the brands it owns, but also customer relationships, if acquired externally, are recognized in the balance sheet as intangible assets. However, the reputation of these brands and how well known they are among its customers also play important roles in the success of its business. Well-established customer relationships that are based on NORMA Group's distribution network that has continually grown over the course of many years are equally important. The know-how and experience of NORMA

37 Principles of the Group
51 Economic Report
 74 Forecast Report
 79 Risk and
 Opportunity Report
 91 Remuneration Report
 98 Other Legally
 Required Disclosures
 101 Report on Transactions
 with Related Parties

Group employees also play important roles in the Company's success. The many years of research and development expertise and project management know-how are also seen as competitive advantages for NORMA Group. These values are not recognized in the balance sheet.

FINANCIAL POSITION

Financing measures

NORMA Group monitors risks from changes in exchange and interest rates on a regular basis and aims at limiting them by using derivative hedging instruments among other tools. Furthermore, NORMA Group generally strives to achieve a diversification of its financing instruments in order to reduce risks. These also include prolongation of repayment obligations and an even distribution of the maturity profile. Most of the supply and service relationships between individual currencies are simultaneously hedged over the course of the year.

As of the reporting date December 31, 2018, the revolving line of credit in the amount of EUR 50 million in the syndicated loan had not been used. In addition, an accordion facility has been negotiated as part of this loan agreement, which was drawn for EUR 102 million as of December 31, 2018. Of the EUR 250 million originally available, EUR 148 million were therefore still undrawn as of the reporting date. These funds are available to NORMA Group until 2022 to ensure a high degree of financing flexibility.

In order to reduce interest rate risks that could result from the external financing components, USD interest rate hedges of nominal EUR 60.2 million were concluded in the fiscal year.

As of December 31, 2018, the average interest rate on total gross debt was 2.5%. NORMA Group's maturity profile for all three promissory notes I (2013), II (2014) and III (2016) and the syndicated credit line (2015) on December 31, 2018, was as shown in the ► **GRAPHICS 016 AND 017**.

As of the balance sheet date in 2018, NORMA Group complied with all of the conditions contained in the loan contracts (financial covenants: debt in relation to consolidated EBITA).

Future concrete financing steps will depend on the current changes in the financing markets and acquisition potentials.

G 016 MATURITY PROFILE BY CURRENCY

IN EUR MILLIONS

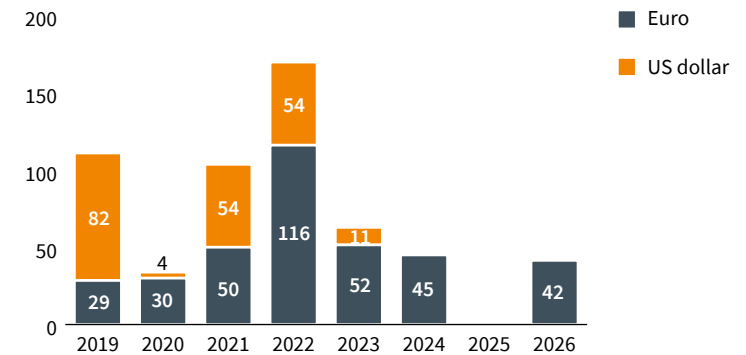

G 017 MATURITY PROFILE BY FINANCIAL INSTRUMENTS

IN EUR MILLIONS

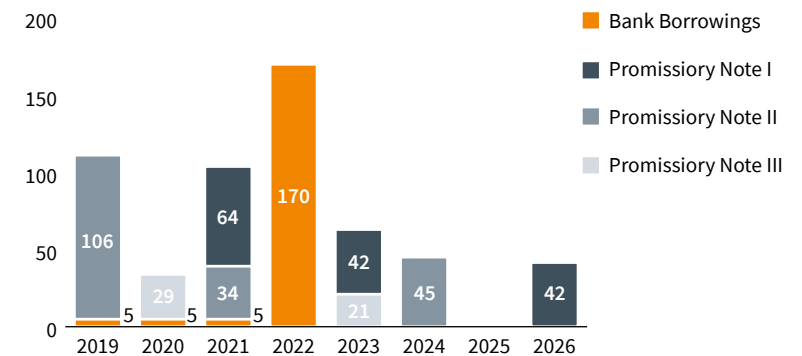

37 Principles of the Group

51 Economic Report

74 Forecast Report

79 Risk and
Opportunity Report

91 Remuneration Report

98 Other Legally
Required Disclosures101 Report on Transactions
with Related Parties**Development of cash flow****Net operating cash flow**

In 2018, NORMA Group generated a net operating cash flow (adjusted EBITDA less changes in working capital and operating expenses) of EUR 124.4 million (2017: EUR 132.9 million). The year-on-year decline is mainly due to higher operating investments in relation to adjusted EBITDA.

Cash flow from operating activities

Cash flow from operating activities, which is derived indirectly from the profit for the period, amounted to EUR 130.8 million in fiscal year 2018 (2017: EUR 146.0 million). NORMA Group participates in a reverse factoring program, a factoring program and an ABS program. The corresponding cash flows are presented under cash flow from operating activities as this reflects the economic substance of the transactions. Liabilities under the reverse factoring program are reported under trade payables and similar liabilities. As of December 31, 2018, liabilities of EUR 19.2 million (Dec 31, 2017: EUR 25.4 million) from reverse factoring programs were recognized. The total amount of trade receivables sold under the factoring and ABS programs amounted to EUR 61.2 million in the fiscal year (2017: EUR 24.2 million). ► **NOTES, P. 160** and ► **P. 161** The programs thus generated a positive cash flow contribution of EUR 26.7 million in fiscal year 2018.

The cash inflow from operating activities also includes payments for share-based payments of EUR 3.5 million (2017: EUR 4.0 million) resulting from the cash remuneration of the 2014 tranche of the MSP (2017: 2013 tranche) and from the Long-Term Incentive plan (LTI) for employees of NORMA Group.

The adjustment for expenses from the valuation of hedging derivatives of EUR 0.4 million (2017: income of EUR 4.6 million) included in the cash inflow from operating activities relates to the change in fair value of foreign currency derivatives allocated to financing activities and recognized in profit or loss.

The adjusted other non-cash income (-)/expenses (+) include income from the currency translation of external financial liabilities and intragroup monetary items amounting to EUR -0.7 million (2017: EUR 5.9 million). In addition, non-cash income (-)/expenses (+) in fiscal year 2018 include non-cash interest expenses of EUR 0.3 million (2017: EUR 0.4 million) from the application of the effective interest method.

Cash flows from interest paid are reported under cash flows from financing activities.

Cash flow from investing activities

In fiscal year 2018, cash outflow from investing activities amounted to EUR 129.5 million (2017: EUR 70.8 million). This includes net payments for acquisitions amounting to EUR 69.8 million (2017: EUR 23.7 million). These relate to payments for the acquisition of Kimplas (EUR 53.6 million) and the acquisition of Statek (EUR 13.6 million). Furthermore, the cash flow from investing activities was influenced in particular by the cash outflow for the procurement of non-current assets amounting to EUR 60.8 million (2017: EUR 47.9 million). This includes expenses for expansion (EUR 42.8 million) as well as for the maintenance and improvement of operating capacities (EUR 20.5 million).

NORMA Group's investing activities in fiscal year 2018 (tangible and intangible assets) in the amount of EUR 60.8 million (2017: EUR 47.9 million) represents an investment ratio of 5.6% (2017: 4.7%) of sales.

NORMA Group is investing the funds from operating cash flow in further growth among other areas. The investments made in the 2018 reporting year related to production facilities and capacity expansion, mainly in the US, Mexico, Poland, Serbia, the United Kingdom and China. ► **PRODUCTION AND LOGISTICS, P. 65**

Cash flow from financing activities

Cash flow from financing activities amounted to EUR 31.3 million in 2018 (2017: EUR -77.7 million). This mainly includes net repayments of loans (EUR 80.2 million), payments for dividends to the shareholders of NORMA Group SE (EUR -33.5 million), and interest payments (EUR -13.7 million).

In addition, payments for the acquisition of the remaining shares in Groen Bevestigingsmaterialen B. V. amounting to EUR 1.1 million are included in cash flow from financing activities. ► **ACQUISITIONS AND CHANGES IN LEGAL STRUCTURE, P. 37**



37 Principles of the Group

51 Economic Report

74 Forecast Report

79 Risk and
Opportunity Report

91 Remuneration Report

98 Other Legally
Required Disclosures101 Report on Transactions
with Related Parties**SEGMENT REPORTING**

As a result of acquisitions and developing new markets in line with NORMA Group's continuing strategy of internationalization, the share of sales realized internationally increased from 80.3% to 81.2%.

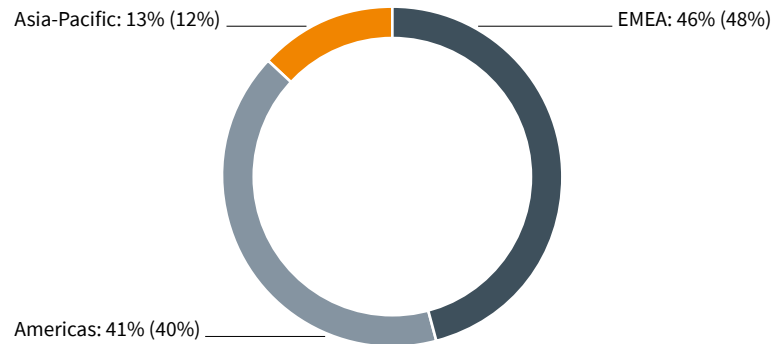
G 018 BREAKDOWN OF SALES BY SEGMENTS¹

¹ Previous year's values in brackets.

Due to the fact that financing as a whole is controlled centrally and exclusively made available through approved external credit facilities by the central functions of NORMA Group, the Company forgoes publishing a separate list of financing by segments. In every segment, the aim is to achieve an investment ratio and cash generation that is in line with the Group average in the medium-term. ► **GOALS REGARDING FINANCE AND LIQUIDITY MANAGEMENT, P. 47**

EMEA

External sales in the EMEA region amounted to EUR 494.8 million in 2018, an increase of 1.8% compared to the previous year (2017: EUR 485.9 million). Organic growth was 2.0% and resulted mainly from the good demand for EJT solutions in the first half of the year, but also from moderate growth in the Distribution Services division. Furthermore, the company Statek that was acquired in August 2018 contributed 0.4% to sales growth (EUR 2.1 million). Changes in exchange rates to the euro had a slightly negative effect of 0.6%.

Due to the relatively stronger growth of the other two regions in fiscal year 2018, the EMEA region's share of total sales declined slightly from 48% to 46%.

Adjusted EBITDA in the EMEA region declined by 9.4% to EUR 95.5 million due to the high costs of materials and other special factors (2017: EUR 105.5 million). ► **PURCHASING AND SUPPLIER MANAGEMENT P. 67** Accordingly, the adjusted

EBITDA margin of 17.6% was below the level of the previous year (2017: 20.0%). Adjusted EBITA amounted to EUR 82.4 million (2017: EUR 93.9 million), a decrease of 12.3% compared to the previous year. The adjusted EBITA margin was 15.2% (2017: 17.8%).

Assets rose by 3.8% to EUR 624.4 million compared to the previous year (2017: EUR 601.3 million), partly due to the acquisition of Statek. Investments amounted to EUR 28.3 million (2017: EUR 22.9 million) and mainly related to investments in new machinery and production facilities in Germany, Serbia, Poland and the United Kingdom.

Americas

External sales in the Americas segment rose by 7.4% to EUR 441.5 million in 2018 (2017: EUR 411.3 million). At 12.4%, organic growth was at a very high level. This was mainly due to the significant recovery of the US markets for commercial vehicles and agricultural machinery as well as an NDS water business strengthened by catch-up effects. Currency effects in connection with the development of the US dollar had a negative effect on sales growth (-5.1%).

Adjusted EBITDA for the Americas region amounted to EUR 87.2 million in 2018, up 3.1% year-on-year (2017: EUR 84.5 million). The adjusted EBITDA margin was 19.3% (2017: 20.0%). Adjusted EBITA increased by 3.5% to EUR 78.3 million (2017: EUR 75.6 million), while the adjusted EBITA margin was 17.4% (2017: 17.9%). Here, too, higher material costs were the main reason for the margin decline. The US customs policy in particular had a negative impact on steel prices.

Assets increased by 8.3% year-on-year to EUR 649.8 million (2017: EUR 599.9 million) mainly as a result of currency effects.

At EUR 21.1 million, investments in the region rose by 29.7% (2017: EUR 16.3 million). Investment focuses included the plants in the US and Mexico.

► **PRODUCTION AND LOGISTICS, P. 65**

Asia-Pacific

External sales in the Asia-Pacific region amounted to EUR 147.8 million and thus rose by 23.2% compared to the previous year. Organic growth was 14.9% and was driven by strong demand for joining technology in the Chinese vehicle industry, which nevertheless weakened considerably over the course of the year. Furthermore, the recent acquisition of the Indian water company Kimplas and the acquisition of Fengfan in fiscal year 2017 contributed 12.0% or EUR 14.4 million to the growth in sales. Currency effects had a negative impact on sales growth at -3.7%.

T022 DEVELOPMENT OF SEGMENTS

IN EUR MILLIONS	EMEA			Americas			Asia-Pacific		
	2018	2017	Δ in %	2018	2017	Δ in %	2018	2017	Δ in %
Total segment sales	543.1	527.9	2.9	451.2	423.1	6.6	151.3	124.2	21.8
External sales	494.8	485.9	1.8	441.5	411.3	7.4	147.8	119.9	23.2
Contribution to consolidated sales (in %)	46	48		41	40		13	12	
Adjusted EBITDA ¹	95.5	105.5	-9.4	87.2	84.5	3.1	23.0	19.1	20.2
Adjusted EBITDA margin (in %) ²	17.6	20.0		19.3	20.0		15.2	15.4	
Adjusted EBITA ¹	82.4	93.9	-12.3	78.3	75.6	3.5	18.3	15.7	16.6
Adjusted EBITA margin (in %) ²	15.2	17.8		17.4	17.9		12.1	12.6	

1_The adjustments are described in the Notes. ► **NOTES, P. 141**

2_In relation to segment sales.

Adjusted EBITDA in the Asia-Pacific region rose by 20.2% to EUR 23.0 million (2017: EUR 19.1 million). The adjusted EBITDA margin was 15.2% (2017: 15.4%), in other words slightly lower than last year's level. Adjusted EBITA increased by 16.6% to EUR 18.3 million (2017: EUR 15.7 million), which resulted in an adjusted EBITA margin of 12.1% (2017: 12.6%).

Assets increased by 57.4% to EUR 250.4 million in the year under review (2017: EUR 159.1 million). This is attributable in particular to the continued growth of the operating business and the acquisition of Kimplas.

Investments, which amounted to EUR 11.7 million in 2018 (2017: EUR 7.0 million), were mainly used to expand the sites in China. ► **PRODUCTION AND LOGISTICS, P. 65**

PRODUCTION AND LOGISTICS

NORMA Group manufactures and markets more than 40,000 different products and has 30 production sites all over the world. Furthermore, the Company has a network consisting of numerous distribution, sales and competence centers that supply to its customers in the respective regions.

In the reporting year 2018, NORMA Group acquired the Indian water company Kimplas and Statek, a company that also has its headquarters in Maintal. In December 2018, NORMA Group also opened a new production plant in Tijuana, Mexico, and thus further expanded its capacities in the Americas region.

► **SIGNIFICANT DEVELOPMENTS IN THE FISCAL YEAR, P. 54**

PRODUCTION AND CAPACITY UTILIZATION

The capacity utilization of NORMA Group's manufacturing and distribution facilities varies from site to site. In markets such as the emerging countries, where NORMA Group's business is still being developed, the area-related utilization of production plants is still relatively low. This can be attributed to the fact that investment decisions are planned in advance to ensure that sufficient production space is available to be able to expand production capacity in a flexible manner. In industrial nations and the markets in which NORMA Group already has a long-term market position and the plants are largely working to capacity, an attempt is made to avoid investing in additional manufacturing space whenever possible. Instead, the goal is to optimize the current manufacturing processes by improving efficiency in order to be able to use the existing space to create additional capacity.

The capacity utilization of manufacturing plants can be ramped up flexibly to suit customer demand and the order situation. Within each product category, a wide variety of different products with different specifications can be manufactured at the existing plants by performing only minor conversion measures. Thus, production can be optimally adapted to suit customer demand.

INVESTMENT IN CAPACITY EXPANSION

NORMA Group once again invested in expanding its capacity during the reporting year. The most important strategic investments are shown in the ► **TABLE 023 ON P. 67.**

CONTINUOUS OPTIMIZATION OF THE ENTIRE VALUE CHAIN

At NORMA Group, all internal processing steps in the value chain are constantly analyzed for optimization potential. The Global Operational Excellence

INTRODUCTION

OUR VISION

TO OUR SHAREHOLDERS

**CONSOLIDATED
MANAGEMENT REPORT**

CONSOLIDATED
FINANCIAL STATEMENTS

FURTHER INFORMATION

- 37 Principles of the Group
- 51 Economic Report**
- 74 Forecast Report
- 79 Risk and Opportunity Report
- 91 Remuneration Report
- 98 Other Legally Required Disclosures
- 101 Report on Transactions with Related Parties

Management System represents an essential tool here that helps to analyze existing processes, identify potential for improvements, introduce the appropriate measures for implementation and realize cost saving projects. As a result, many processes have already been automated and standardized in recent years, so that significant economies of scale have been achieved.

NORMA Group introduced the NORMA Group Production System (NPS) in 2014, which has been rolled out at all of its plants. The goal of the NPS is to increase operational performance, safety, delivery reliability and quality in the plants and to identify and realize further cost savings. NORMA Group uses a “toolbox” of lean methods. These include the 5S methodology, the daily Gemba walk, setup time optimization using SMED (Single Minute Exchange of Die) and TPM (Total Productive Maintenance). In addition, a standardized problem-solving process ensures that internal and external customer complaints are processed faster and more effectively.

CUSTOMER FOCUS AND SECURE SUPPLY CHAIN

In order to optimize its logistics costs, NORMA Group always strives to keep the geographical distances in the value chain as short as possible and avoid non value-adding intermediate steps via other NORMA Group sites. The goal is therefore to always manufacture in the regions that its customers are based in. This not only optimizes working capital and lowers logistics costs, but also minimizes delivery risks, reduces negative impacts on the environment and ensures the higher level of flexibility that is being increasingly demanded.

Despite these efforts, cross-border deliveries are indispensable for NORMA Group in many places in order to be able to respond flexibly to customer requirements. Optimized and secure customs processes are therefore indispensable. For this reason, NORMA Group participates in various customs partnership programs, for example in the US, China and the EU. Through the export control program, which is part of the worldwide compliance program, NORMA Group ensures a fully compliant supply chain. By regularly reviewing all its business partners, NORMA Group excludes the supply of legally sanctioned third parties. In addition, internal organizational instructions and regular reviews ensure compliance with the relevant statutory export control regulations.

QUALITY MANAGEMENT

The products supplied by NORMA Group are used in ‘mission-critical’ applications and therefore any quality defects or functional failures have significant impact on customers or end users. Thus, it is a clear business imperative that NORMA Group consistently delivers products that meet and surpass all customers’ quality needs and expectations.

To support this objective and ensure a global and standardized approach to quality, all NORMA Group manufacturing locations (acquisitions have a nominal 12-month target for accreditation) are accredited in accordance with either ISO 9001 or IATF 16949. In addition, two manufacturing sites that supply the aerospace industry are accredited in accordance with EN 9100. Compliance with these industry-recognized standards ensures that NORMA Group continuously strives for improvement in every aspect of business and puts customers at the center of all activities.

NORMA Group has a global operating footprint, which brings with it the challenge of recognizing and understanding customer diversity, along with the many specific standards and market requirements that vary by region. This challenge is met via localized manufacturing solutions in conjunction with standardized NORMA Group tools, such as the Quality Management software, which forms an integral part of the new Microsoft ERP system currently being rolled out across the entire Group.

NORMA Group uses a number of metrics to measure customer quality, satisfaction and delivery performance. The most important key performance indicators are the number of defective parts shipped, expressed in parts per million (PPM), and the average number of quality-related complaints reported by the customer.

The number of defective parts per million (PPM) recorded in 2018 was seven. This is a significant improvement from the 16 (PPM) reported in 2017. Thus, there is a constant improving trend over the last three years. Also the average number of quality-related customer complaints improved to seven in 2018 from nine reported in 2017.



37 Principles of the Group

51 Economic Report

74 Forecast Report

79 Risk and
Opportunity Report

91 Remuneration Report

98 Other Legally
Required Disclosures101 Report on Transactions
with Related Parties**T 023 STRATEGIC INVESTMENT HIGHLIGHTS 2018**

Region	Country	City	Investment
EMEA	Serbia	Subotica	▶ Establishment of new production capacities for a newly developed SCR system to accommodate a major order from a leading European automobile manufacturer
	Poland	Pilica	▶ Installation of new manufacturing capacities in the area of fluid systems to manage major new projects from customers ▶ Expansion of the PS3 connector manufacturing capacities for the global platform of a leading automobile manufacturer
	United Kingdom	Newbury	▶ Investment in a new transfer press system to expand capacities for V profile clamps
Americas	USA	Saltsburg, PA	▶ Modernization of the manufacturing capacities by fully automating the heavy-duty constant torque (CTH) product line
		St. Clair, Michigan	▶ New assembly systems for the fluid area to promote growth ▶ Investments in new molding tools to support new customer projects in the fluid area
		Lindsay, California	▶ Investment in a new foam extrusion line for an innovative product line in the area of water management
	Mexico	Monterrey	▶ Establishment of manufacturing capacities for SCR systems for a leading automobile manufacturer
Asia-Pacific	China	Qingdao	▶ Installation of a new multilayer extrusion line for the localization of new products in the area of fluid and e-mobility ▶ Expansion of the manufacturing capacities in the area of cooling water systems to accommodate new customer orders
		Changzhou	▶ Expansion of the manufacturing capacities in the area of Torro clamps for the Asian market
		Wuxi	▶ Investment in the structural expansion of the manufacturing site for fluid components

PURCHASING AND SUPPLIER MANAGEMENT

Material costs represent the highest cost position for NORMA Group. As they significantly affect the Group's profits, purchasing and supplier management both play a decisive role in the success of the Group. The most important goals are to reduce price risks and leverage economies of scale within the Group through proactive management of the direct and indirect costs of materials and services purchased.

GLOBAL GROUP STRUCTURE AND REGIONAL EXPERTISE

Purchasing and supplier management at NORMA Group are organized primarily on the basis of the following three higher level commodity groups:

- ▶ Steel and metal components (various grades/materials)
- ▶ Resins, plastic and rubber products
- ▶ Capital goods, non-production materials and services

The commodity organization is integrated into NORMA Group plants worldwide in the form of a matrix structure. Purchasing at NORMA Group is controlled centrally for all domestic and foreign Group companies, while regional or local teams contribute their specific knowledge of local market conditions and typical regional cost drivers. Due to the high degree of professionalism and the combination of global, regional and local purchasing management, materials and services can be purchased much more competitively; costs can therefore be reduced quite significantly. Using e-procurement solutions allows for more efficient purchasing management.

DEVELOPMENT OF MATERIAL PRICES

Adjusted costs of materials amounted to EUR 473.1 million (2017: EUR 418.6 million) or 43.6% (2017: 41.2%) of sales revenue in fiscal year 2018. As a result, the adjusted cost of materials ratio increased compared to the previous year due to the higher costs of raw materials. ► **DEVELOPMENT OF EARNINGS, P. 57** The purchasing volume used for internal management purposes and adjusted for currency effects amounted to around EUR 498 million (2017: EUR 433 million). Of this amount, EUR 336 million (68%) was attributable to production material sales.

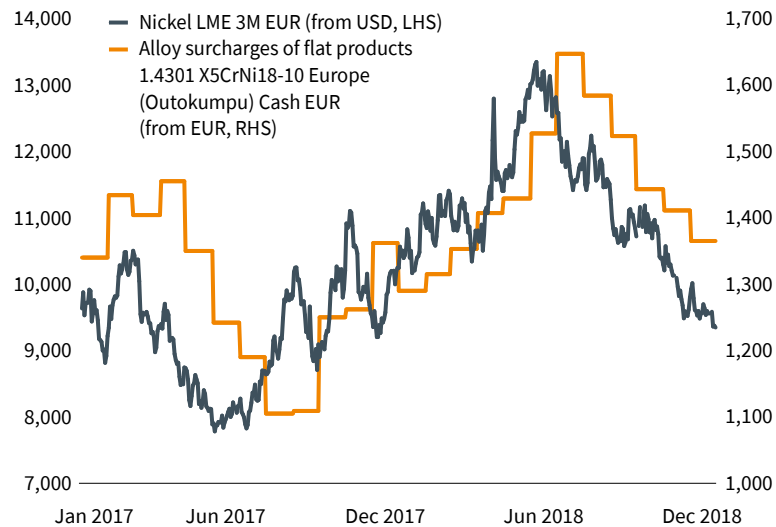
**G 019 DEVELOPMENT OF NICKEL PRICES AND
THE ALLOY SURCHARGE 1.4301**

For the stainless steel product group, which is the most important for NORMA Group, almost unchanged base prices (basic price to purchase stainless steel, excluding alloy surcharges) could be maintained in the annual price negotiations. However, the 25% punitive tariffs, imposed by the US government on almost all steel imports in March 2018, represented a protectionist intervention in international trade and led to massive increases in the price of goods purchased in the region. Although NORMA Group was contractually secured by annual contracts in this area, government intervention in the second half of 2018 led to a partial reduction in the availability of materials, which had to be offset by taking cost-intensive special measures. This also resulted in a significant increase in the general market price level for steel in the US. For some stainless steel goods, spot market prices rose proportionately over the course of the year

and were up to 30% higher at the end of the year than at the start of the year. The import tariffs imposed on steels and metal components purchased continued to constitute a financial burden for the entire region.

In addition to the market distortions in the steel sector caused by US customs policy, the prices for the alloy surcharges newly fixed on a monthly basis (market prices for nickel and ferrochrome, among other metals) increased successively in the first half of the year and peaked in July and August 2018. Although prices dropped again in the second half of the year, the price level at the end of the year was still significantly higher than at the beginning of the year.

► **G 019: DEVELOPMENT OF NICKEL PRICES AND THE ALLOY SURCHARGE 1.4301**

In the surface-refined non-stainless steel product group, higher purchasing prices than in fiscal 2017 had to be accepted in the price negotiations for European demand. Nevertheless, as the availability of materials eased significantly over the course of the year compared to the previous year and prices dropped again at the end of the year, a slightly decreasing trend in prices can be assumed again for the current year 2019.

The product group of technical resins was also characterized by strong price increases last year. ► **G 020: PRICE DEVELOPMENT TECHNICAL POLYMER (PA66) IN EUROPE** This particularly affected the polyamide 6.6 required for the production of high-performance connectors. This was due to a series of force majeure declarations along the (PA66) value chain caused by strikes, extreme weather conditions and technical disruptions at major suppliers. As a consequence, there were delivery bottlenecks and price mark-ups, particularly in Europe and Asia, as a result of which suppliers adjusted their annual contracts several times during the year, which could not be fully passed on to customers. However, NORMA Group successfully managed to avoid impending bottleneck situations due to its longstanding and trusting cooperation with important suppliers. Due to continuing high demand for technical resins, the market remains tense and allocations cannot be excluded. Should further bottlenecks arise, this could also lead to further price increases in the current year 2019.

37 Principles of the Group
51 Economic Report
 74 Forecast Report
 79 Risk and Opportunity Report
 91 Remuneration Report
 98 Other Legally Required Disclosures
 101 Report on Transactions with Related Parties

G 020 PRICE DEVELOPMENT TECHNICAL POLYMERS (PA66) IN EUROPE

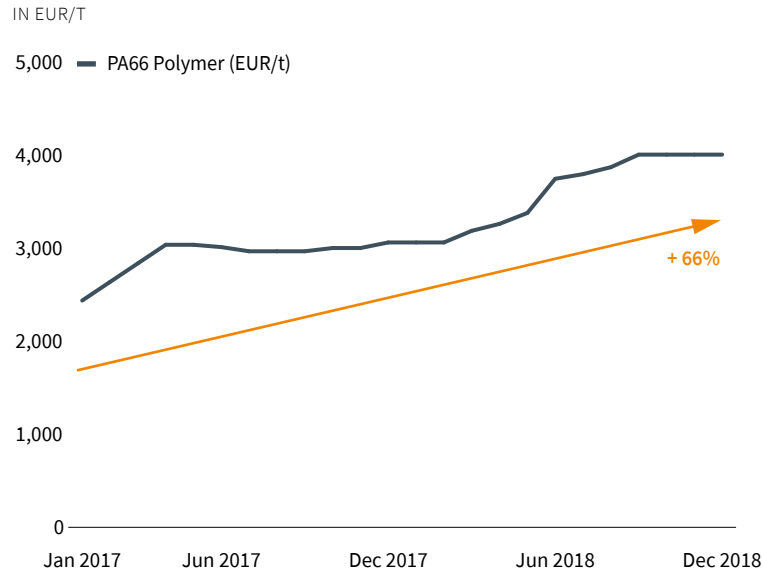

G 021 PURCHASING TURNOVER 2018 BY MATERIAL GROUPS

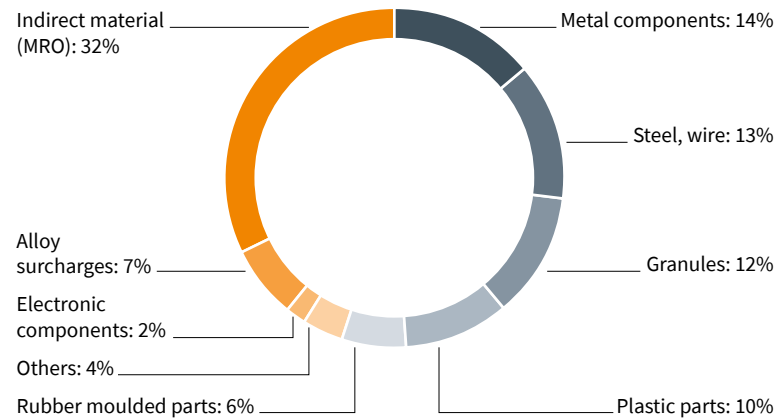

SUPPLIER MANAGEMENT

Constantly optimizing the selection of suppliers is yet another key task of purchasing. This is done not only on the basis of traditional criteria such as quality,

price, delivery times and loyalty, but also takes important aspects of risk management and sustainable development into consideration. A centrally defined, detailed supplier evaluation system is used by all of the production plants each year. ▶ **2018 CR REPORT**

SUPPLIER STRUCTURE

NORMA Group is taking advantage of the complexity and transaction cost-reduction opportunities resulting from the Company's growth and acquisitions, and has been strongly pursuing its goal of consolidating its supplier base. NORMA Group nevertheless pays close attention to a balanced supplier structure and avoids dependencies on individual suppliers. The share of the top 10 suppliers accounted for approximately 33% in the fiscal year. The top 50 suppliers accounted for around 64% of the total purchasing volume of production material, amounting to EUR 336 million.

EMPLOYEES

DECENTRALIZED ORGANIZATION, COMMON CORPORATE CULTURE

The employees of NORMA Group make an important contribution to its success. Human resources management and development therefore play a very important role.

HR management at NORMA Group is organized in a decentralized manner to take the international nature of the business and the rapid growth of NORMA Group into account. Decentralized personnel management allows the individual sites to adapt flexibly to the local conditions and to contribute their regional expertise in personnel development and recruiting.

In order to promote a uniform corporate culture, NORMA Group has formulated key guiding principles that reflect the fundamental convictions of the Company. These guiding principles are taught and lived at all sites. ▶ **2018 CR REPORT**

DEVELOPMENT OF PERSONNEL FIGURES

At the end of December 2018, NORMA Group employed a Group workforce of 8,865 (core workforce including temporary staff), 16% more than in the previous year (2017: 7,667). The number of temporary employees on the reporting date was 1,964 (2017: 1,552). This corresponds to around 22% of the total workforce.

NORMA Group recorded the largest increase in its workforce in 2018 in the growth region Asia-Pacific. In this region, the core workforce increased to 1,315 employees, partly as a result of the acquisition of Kimplas. In the Americas

region, the number of employees increased by 17% year-on-year, while it rose by 6% in the EMEA region.

STABLE SHARE OF EMPLOYEE GROUPS

The total number of employees (permanent and temporary) in the year under review was 4,951 direct employees (2017: 4,243), 1,626 indirect employees (2017: 1,414) and 2,289 salaried employees (2017: 2,009). While direct employees are individuals who are involved in the manufacturing process, indirect employees are employees who work in production-related areas such as the quality department, for example. The group of salaried employees refers mainly to employees who hold administrative positions.

T 024 CORE WORKFORCE BY SEGMENTS

	2018	in %	2017	in %
EMEA	3,744	54	3,545	58
Americas	1,842	27	1,575	26
Asia-Pacific	1,315	19	995	16
Total	6,901		6,115	

G 022 PERSONNEL DEVELOPMENT AT NORMA GROUP

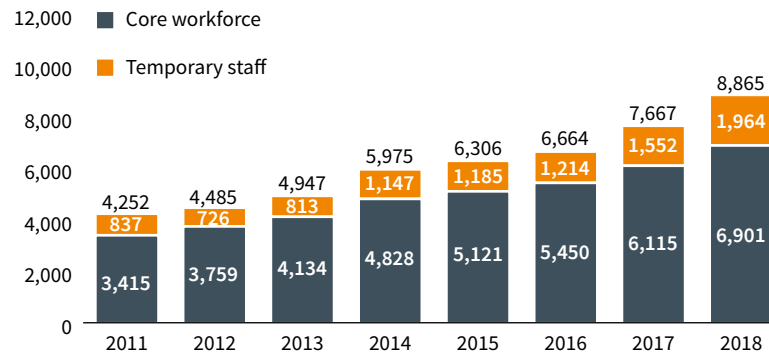

QUALIFIED WORKFORCE

The employees of NORMA Group are well trained and obtain their qualifications by earning school and university degrees and by participating in professional and supplementary training. In order to maintain the high degree of innovative capacity and ensure the successful development of the Group in the future, NORMA Group invests in the training and further education of its employees. The goal is to recruit as many specialized employees as possible from one's own

junior staff, thereby becoming more independent of the external labor market. NORMA Group also cooperates closely with universities.

G 023 BREAKDOWN OF EMPLOYEES BY GROUP

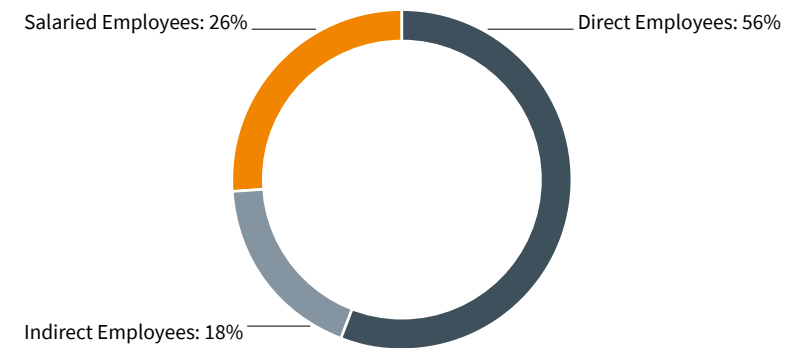

Uniform global talent promotion

In order to identify, retain and develop talents within the Group, NORMA Group set up the 'Learning & Development' competence center a couple of years ago. The competence center acts as an internal consultant to the local HR departments, executives and employees. The focus of the initiative is on the conception and supply of development processes and programs that can be used worldwide, which are aligned with NORMA Group's Company values and growth targets. In order to promote learning at the workplace and the individual development of its employees, direct supervisors as well as internal mentors and coaches are made available. As part of the project, various local and regional human resources development methods have been integrated into a global portfolio. This ensures uniform global talent promotion for all NORMA Group employees.

Numerous training opportunities for career entrants

Besides accompanying courses of studies in the areas of business engineering, mechanical engineering, mechatronics and business administration, NORMA Group also offers internships for students in all departments and regions. Furthermore, young people are trained in various technical and commercial areas.

37 Principles of the Group

51 Economic Report

74 Forecast Report

79 Risk and
Opportunity Report

91 Remuneration Report

98 Other Legally
Required Disclosures

101 Report on Transactions
with Related Parties

EXCHANGES OF PERSONNEL:

MORE COMMUNICATION, BETTER UNDERSTANDING

NORMA Group will continue to grow internationally in the future, both organically and through acquisitions. In order to be able to integrate new parts of the Group, the individual sites need to work together efficiently. Thus communication that functions well is essential. To encourage this, NORMA Group offers several exchange programs for its employees, from one to three-month so-called 'Bubble-Assignments' to 'Long-Term-Assignments.' Expert personnel and managers who participate in this initiative bring special skills and experience to the new sites and, at the same time, benefit from the know-how of their local colleagues. Through these projects, NORMA Group promotes the internal transfer of knowledge, intercultural awareness, the establishment of networks and the individual development of the participants.

REWARDING PERFORMANCE

NORMA Group strives to attract and retain qualified and committed employees. By holding regular benchmarks, NORMA Group ensures that its employees are paid market-oriented salaries and wages based on their responsibilities. The remuneration system also contains variable remuneration elements to encourage employees to take an interest in the further development of the Company and share in its economic success. For tariff and non-tariff employees in Germany, this is based on important financial performance indicators, for example. Moreover, the personal achievements of employees also play a role in remuneration.

FEEDBACK CULTURE – EMPLOYEES EXPRESS THEIR OPINIONS

In the interest of a continuous analysis and improvement process, NORMA Group has been conducting regular employee surveys. The focus of this central feedback tool is on the Company's strengths and weaknesses from an employee perspective, employee satisfaction, as well as the quality of leadership and co-operation. Further information can be found in the ► **2018 CR REPORT**.

HEALTHY TEAM – HEALTHY COMPANY

A productive company like NORMA Group depends on having healthy and satisfied employees. For this reason, NORMA Group supports its employees' health by conducting various activities. For example, the Maintal site offers measures such as skin screening, colorectal cancer screening, travel vaccination advice, movement analysis at work, back training courses and flu vaccinations.

OCCUPATIONAL HEALTH AND SAFETY IS OF THE HIGHEST PRIORITY

NORMA Group puts great focus and emphasis on the topics health, safety and the wellbeing of its employees. The Company complies with the existing legislative and regulatory requirements relating to health and safety, but also goes further with a number of actions and initiatives to proactively manage and minimize potential risks. NORMA Group fully endorses the industry-recognized standard OHSAS 18001 (Occupational Health and Safety Assessment Series).

As part of its value-based safety program, NORMA Group analyzes the actions of its employees in the workplace and identifies potentially dangerous behaviors as part of regular safety reviews. This is also in conjunction with regular scheduled plant and equipment audits with results and action plans being developed and monitored locally and at Group level.

INCIDENT RATE AT A SUSTAINABLE LOW LEVEL

NORMA Group constantly monitors and analyzes its accident statistics. The number of work-related accidents, ranging from near miss incidents to reportable accidents, are recorded and monitored on a Group-wide basis each month and reviews take place at the local, regional and Group levels. All reportable accidents are communicated at Board level with lessons learned systematically shared across the whole Company. The aim of NORMA Group is to ensure an accident-free working environment in the long-term.

The incident rate, which is the number of reportable accidents per 1,000 employees, represents the most important indicator. This figure was 8 for the 2018 reporting year, which is a slight increase from six reported in 2017.

► **G 024: INCIDENT RATE**

G 024 INCIDENT RATE

REPORTABLE INCIDENTS PER 1,000 EMPLOYEES

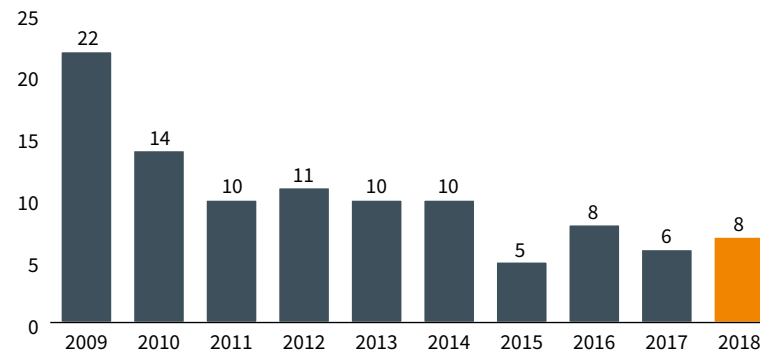
**ENVIRONMENTAL PROTECTION AND
ECOLOGICAL MANAGEMENT**

As a manufacturing Company, NORMA Group is well aware of its environmental, economic, and social responsibility. Environmentally compatible and sustainable economic activity is therefore a central element of its corporate strategy. For this reason, the Company considers it important to systematically include environmental aspects in its business decisions. Therefore, NORMA Group has implemented a Group-wide environmental management system and certifies its production sites in accordance with ISO 14001.

NORMA Group's goal is to increase the efficiency of its production processes, lower its energy consumption over the long term, and reduce waste. The long-term cost savings associated with this contribute to the economic efficiency of the Group.

In 2018, NORMA Group set quantitative targets for the reduction of greenhouse gases, water consumption and waste generated at its production sites. In addition, NORMA Group's environmental strategy includes the environmental impact of the supply chain and the use of its products. Further information on the environmental strategy can be found in the ► **2018 CR REPORT**.

MARKETING

In order to further increase awareness of NORMA Group's products all over the world, boost product sales, strengthen its customer relationships and thus contribute to the Group's growth, NORMA Group's long-term marketing strategy is based on the following objectives:

- ▶ Building a strong NORMA Group image
- ▶ Focusing on marketing activities
- ▶ Optimizing the brand portfolio
- ▶ Optimizing marketing tools
- ▶ Gaining a better understanding of market needs

In order to be able to focus on its end markets and customers as much as possible, NORMA Group aligns all of its marketing activities to address local market conditions and consumer habits in its respective regions and markets. The regional marketing units are responsible for executing the various activities and synchronizing them with NORMA Group's operative objectives.

MARKETING FOCUS IN 2018

Key marketing activities in 2018 included the following:

- ▶ Implementation of the digital marketing roadmap 2021
- ▶ Collection of market intelligence to support key sales initiatives
- ▶ Developing a communication strategy for e-mobility in order to promote the solutions of NORMA Group in the area of thermal management

Furthermore, another focus was on traditional marketing activities such as organizing Tech Days at customer sites and participating in fairs and exhibitions in order to promote NORMA Group's product solutions to their targeted markets.

MARKETING EXPENDITURES 2018

Marketing expenditures amounted to a total of EUR 4.5 million and were thus slightly higher than in the previous year (2017: EUR 4.2 million).

37 Principles of the Group
51 Economic Report
74 Forecast Report
79 Risk and
Opportunity Report
91 Remuneration Report
98 Other Legally
Required Disclosures
101 Report on Transactions
with Related Parties

G 025 MARKETING EXPENSES 2018 BY SEGMENTS ¹

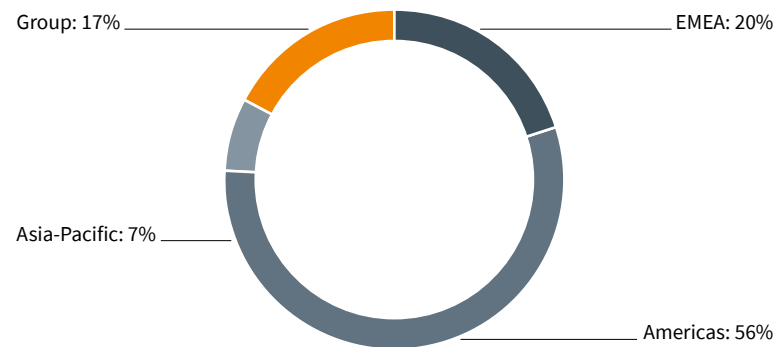

¹ Excluding personnel expenses.

37	Principles of the Group
51	Economic Report
74	Forecast Report
79	Risk and Opportunity Report
91	Remuneration Report
98	Other Legally Required Disclosures
101	Report on Transactions with Related Parties

FORECAST REPORT

GENERAL ECONOMIC AND INDUSTRY-SPECIFIC CONDITIONS

GLOBAL ECONOMIC SLOWDOWN IN 2019 AND HIGHER RISKS, ESPECIALLY FOR EUROPE

The global economy will experience significantly less tailwind in 2019 than in recent years. Leading indicators such as the Ifo Institute's World Economic Survey suggest a weakening of the economy. The International Monetary Fund (IMF) lowered its forecasts once again in January 2019 after revising them last fall. The IMF now expects global growth of 3.5% for 2019 and 3.6% for 2020 (previously 3.7% each). The upswing is slowing down in the three major economic regions of the US, China and Europe in particular. The biggest risk factors are an intensification and expansion of protectionism, an even stronger economic slowdown in China and the Brexit. For Europe, Italy's and France's high national debt also poses a burden, not least for the stability of the monetary union. Furthermore, the real economy could falter due to a flare-up of geopolitical crises or turbulences on the financial markets. In view of the sharp deterioration in the risk profile, uncertainties are more pronounced than in recent years. This makes the global economy particularly susceptible to disruptions, especially in Europe.

According to the IMF, China will grow considerably more slowly in 2019, at only 6.2%, as the previous US restrictions are weighing heavy on industrial activity. An intensification of the trade conflict would dampen growth even further. Due to the high level of private and public debt, the scope for massive economic stimulus programs is limited. Thanks to high infrastructure investments, however, the ASEAN-5 states are likely to grow stably with growth rates of 5.1% (2019) and 5.2% (2020), respectively. The IMF also expects India to continue its strong upswing at rates of more than 7%, even at a slightly accelerated pace. Brazil's economy is also continuing to pick up. With falling oil and gas prices and continued sanctions, Russia remains on only a moderate course. Following a slight slowdown in 2019 (+4.5%), growth in the emerging markets and developing countries is already expected to recover next year (2020: +4.9%).

In the weaker global environment, the economies of the industrialized nations are cooling down noticeably. Above all, industrial production and investments are being adversely affected. The IMF expects growth to slow to 2.0% (2019) and 1.7% (2020) for all industrialized countries combined. There are signs of an economic slowdown in the US, which grew strongly in the previous year. The initial impulses from the tax reform are coming to an end, and losses from the trade conflict are also having a negative impact. According to the IMF, growth in 2019

will still be robust at 2.5%, but is expected to weaken further in 2020. At 1.9%, Canada is expected to expand more moderately than recently in both years. In Japan, the IMF expects weak growth in 2019 and hardly any growth in 2020. The UK economy will remain on a subdued growth course as a result of the Brexit. A disorderly exit from the EU would significantly worsen the outlook.

Europe's economy is caught between a robust domestic economy and considerable political challenges. Besides the Brexit, which is having an increasingly negative impact on the real economy, the high level of debt in the EU countries with structural deficits is slowing growth. Furthermore, a trade conflict with the US cannot be ruled out. In many cases, demographics and a shortage of skilled workers are now limiting growth potential. On the other hand, this bottleneck supports a high level of employment and thus private consumption. Production and employment are likely to rise slightly in the euro zone. The IMF expects only moderate growth for the monetary union (2019: +1.6%, 2020: +1.7%). Dynamic growth is leveling off above all in France, Italy, Spain, Austria and the Netherlands. The pace of growth remains above average in Eastern Europe. Private and government consumption are the economic pillars of the euro zone. Capital spending is also expected to increase significantly in 2019. However, this effect is expected to decrease noticeably the following year. The upswing in Germany is continuing at a moderate pace. Last year's economic dip caused by the decline in production in the automotive industry should be overcome in 2019. The industry is working at full capacity and capacities are growing only slightly despite investments. Private consumption and construction investments remain robust. The IMF is now forecasting growth of 1.3% for 2019.

T 025 FORECASTS FOR GDP GROWTH (REAL)

IN %	2018	2019e	2020e
World ¹	+3.7	+3.5	+3.6
USA ²	+2.9	+2.5	+1.8
China ³	+6.6	+6.2	+6.2
Euro zone ⁴	+1.8	+1.6	+1.7
Germany ⁵	+1.5	+1.3	+1.6

Sources: 1_ IMF; 2_ US Trade Ministry; 3_ National Bureau of Statistics (NBS); 4_ Eurostat, 5_ German Federal Statistical Office (Destatis)

37 Principles of the Group

51 Economic Report

74 Forecast Report79 Risk and
Opportunity Report

91 Remuneration Report

98 Other Legally
Required Disclosures101 Report on Transactions
with Related Parties**VOLATILE ENVIRONMENT FOR NORMA GROUP'S****KEY CUSTOMER INDUSTRIES**

The climate and prospects for NORMA Group's key customer industries will also tend to deteriorate due to the expected weakening of the global economy in 2019 and 2020, albeit with a continuing positive underlying trend.

Mechanical engineering

In the wake of the global economic slowdown, the investment climate will most likely gradually cool down. Nevertheless, industrial capacity utilization is still high, especially in the industrialized countries, and the order situation in the mechanical and plant engineering sector is good. This should stabilize the trend. Automation and digitalization are also key drivers in the industry. In addition, more and more countries are pushing environmental protection investments and the restructuring of the energy industry. The German Engineering Federation (VDMA) expects the upturn in the sector to continue in 2019, with real growth in global machine sales slowing to 2%. For China, the VDMA expects a 3% increase, assuming that there is no escalation in the trade conflict. By contrast, growth in the US is expected to flatten to 2%. Growth in Asia's emerging markets (excluding China) and the Gulf region is robust. Sector sales in Japan (+2%) and South Korea (+1%) are expected to grow moderately. Growth rates of 2% are forecast for the EU and the euro zone. The VDMA also expects sales in Germany to rise by 2% in real terms. Production by German mechanical engineering companies is likewise expected to rise by 2% in real terms in 2019. However, this assumes that no trade conflict breaks out with the US and that the Brexit will not cause incalculable turbulences.

**T026 ENGINEERING: REAL CHANGE
IN INDUSTRY SALES**

IN %	2017	2018	2019e
China	8	2	3
USA	3	5	2
Euro zone	4	4	2
World (excluding China)	6	4	2

Source: Mechanical Engineering Industry Association (VDMA)

Automotive industry

The automotive industry is currently undergoing a major transition. Autonomous driving and electromobility (including hybrid drives) are the driving factors. The development of fuel-efficient and low-consumption combustion engines is vital to reducing emissions. Following last year's stagnation, the global automotive market is expected to grow slightly in 2019. China should be able to overcome the temporary market burdens and Europe should make up for the

losses caused by the introduction of WLTP. Risks include US trade policy and the Brexit. For the narrowly defined passenger car market, the German association VDA expects a global rise in sales of 1% to approximately 85.9 million vehicles in 2019. LMC Automotive (LMCA) expects the global market for light vehicles (LV, up to 6 tons) to grow by 1.0% to 95.6 million LV (+1.1%). Here, LMCA assumes production growth of 1.9% in LV in China and 0.5% in North America. According to LMCA estimates, LV sales in Western Europe are expected to increase by 1.3%, while production is expected to fall by 0.5 % if the export outlook deteriorates. Global LV production is expected to grow more strongly again in 2020. After three years of growth, the truck market is expected to suffer a cyclical setback. Production and sales are projected to drop by 4.5% in 2019 and increase slightly in 2020.

**T027 AUTOMOTIVE INDUSTRY: GLOBAL PRODUCTION AND
DEVELOPMENT OF SALES (LIGHT AND COMMERCIAL VEHICLES)**

IN %	2017	2018	2019e	2020e
Production of light vehicles	2.3	-0.5	1.1	2.9
Sales of light vehicles	2.4	-0.2	1.0	2.2
Sales of commercial vehicles	19.4	3.7	-4.5	0.4

Source: LMC Automotive

Construction industry

In a new analysis of the 19 most important individual markets, the Euroconstruct industry network (including the ifo Institute) forecasts an unbroken upswing for the construction industry in Europe through 2021 due to low interest rates and high demand. The momentum is gradually leveling off, especially in residential construction (2021: below +1%). Steady growth of 1.5% per year is assumed for other types of building construction. Civil engineering is expected to achieve above-average growth rates with high public investments, especially in the transport infrastructure, however these are expected to decline from 5% in 2019 to 2.5% in 2021. Euroconstruct expects real construction output in the core European countries to rise by 2.0% in 2019 (West: +1.5%, East: +9.1%). The German construction industry remains on course for growth. The IfW expects real construction investments to increase by 3.1% in 2019 and 3.7% in 2020. This development will be driven by lively residential construction (2019: +4.0%) and high investments in public construction (2019: +3.8%). Commercial construction is likely to grow only moderately in 2019, posting real growth of 0.8%. Based on the construction volume in 2019, the German Institute for Economic Research (DIW) expects a nominal increase of 7.6% to EUR 247 billion in the residential construction segment, with the volume of new construction growing by 7.4%. Construction work on existing buildings is expected to rise by 7.7%, while



- 37 Principles of the Group
- 51 Economic Report
- 74 Forecast Report**
- 79 Risk and Opportunity Report
- 91 Remuneration Report
- 98 Other Legally Required Disclosures
- 101 Report on Transactions with Related Parties

the DIW expects the construction volume for other building construction (excluding housing) to rise by 6.6% and civil engineering by 8.0%.

T 028 CONSTRUCTION INDUSTRY: DEVELOPMENT OF EUROPEAN CONSTRUCTION OUTPUT

IN %	2017	2018	2019e	2020e
Western Europe	3.9	2.2	1.5	1.4
Eastern Europe	9.3	13.4	9.1	3.9
Europe	4.1	2.8	2.0	1.6

Source: Euroconstruct / ifo Institute (19 core markets in total)

This macroeconomic perspective is the basis for NORMA Group's forecast and outlook for 2019.

Changes in key figures resulting from the first-time application of IFRS 16 are not taken into account in the forecast. The 2019 Annual Report will include a comparison of the calculation based on the old and new standards.

FUTURE DEVELOPMENT OF NORMA GROUP

NORMA Group will continue with its successful international growth strategy and pursue the targets defined in Vision 2025. ► **GOALS AND STRATEGY, P. 42** The diversification of the business with regard to end markets, regions and customers will continue to be a priority in the future. A particular focus here is on the promising areas of water management and electromobility, which also form a focal point of NORMA Group's development activities. ► **RESEARCH AND DEVELOPMENT, P. 48**

In addition, business activities will be selectively expanded through further acquisitions. M&A activities will focus on companies that either contribute to market consolidation or serve to enter new high-margin markets. In addition, internationalization and in particular the expansion of activities in the Asia-Pacific region will continue to be the focus. This is to exploit the opportunities in this important growth market and to transfer the added value to the respective region or country.

In addition, NORMA Group continues to work intensively on implementing the sustainability targets defined in the CR Roadmap 2020. One of the focal points here is the quantification of environmental impacts in the supply chain.

► **2018 CR REPORT**

GENERAL STATEMENT BY THE MANAGEMENT BOARD ON THE PROBABLE DEVELOPMENT

SALES GROWTH IN 2019

Due to the current good order situation in the EJT division and NORMA Group's diversified business across many different end markets, the Management Board expects further Group sales growth in 2019, even though it sees a weakening growth dynamic compared to the previous year. The main reasons for this include the diminishing growth of the global economy, the ongoing uncertainty in the European automobile industry due to the WLTP issues and weaker demand from the Chinese automotive industry.

The Management Board sees risks that could have a negative impact on the sales and earnings situation of NORMA Group primarily in the uncertain outcome of the Brexit, the trade dispute between the US and China and the persistently difficult environment on the global commodity markets.

For the EMEA region, the Management Board expects moderate organic growth in fiscal year 2019 due to the not yet fully solved WLTP issue and less dynamic growth forecasts in the automotive sector. The Management Board sees growth drivers in particular in positive effects from new product ramp-ups as a result of increasingly strict emission regulations and the growing number of application solutions for electric mobility.

For the Americas, the Management Board expects moderate organic growth in sales compared to the previous year that are likely to be driven by continued strong NDS water business and slight growth in the area of commercial vehicles and agricultural machinery. For the US passenger car market, the Management Board expects to see only slight growth this year. The Management Board sees risks for the region in particular in the still unresolved trade conflict between the US and China and in the protectionist customs policy of the US government, which will also have a negative impact on domestic companies.

The dynamic development of NORMA Group's business in the Asia-Pacific region will continue this year despite lower growth prospects for China, therefore the Management Board again expects strong organic growth. The Management Board sees growth in business activities, stricter emissions regulations for passenger cars, increased content per vehicle and further localization measures in that region to be the growth drivers. All in all, moderate growth can be expected for both DS and the EJT business in fiscal year 2019.

Against the backdrop of the described assumptions, the Management Board of NORMA Group expects the Group's moderate organic sales growth to be at

37 Principles of the Group

51 Economic Report

74 Forecast Report79 Risk and
Opportunity Report

91 Remuneration Report

98 Other Legally
Required Disclosures101 Report on Transactions
with Related Parties

around 1% to 3% for fiscal year 2019 compared to 2018. In addition, the acquisitions Kimplas and Statek are expected to generate approximately EUR 13 million in total sales. Currency effects can also have a positive or negative impact on growth, depending on the exchange rates to the euro.

DEVELOPMENT OF KEY COST ITEMS

The Management Board of NORMA Group assumes that material prices will remain at a relatively high level again in fiscal year 2019. Reasons for this include the continuing bottlenecks in the area of engineering plastics triggered by the many cases of force majeure in fiscal year 2018, as well as the protectionist trade policy of the US government, which led in particular to rises in prices in the area of steel. Nevertheless, the steady increase in the degree of professionalization in purchasing and the ongoing individual price negotiations with customers should enable further cost increases to be absorbed and thus maintain the adjusted cost of materials ratio roughly at the level as in previous years.

As a result of the Group's continuous growth and the strengthening of activities in the Asia-Pacific region, the Management Board expects a steady increase in adjusted personnel costs in relation to sales in 2019 and therefore a stable adjusted personnel cost ratio roughly at the level as in previous years.

INVESTMENT IN RESEARCH AND DEVELOPMENT

To sustain its innovation and competitiveness in the long term, NORMA Group aims to achieve an annual investment rate of 5% of EJT sales in its R&D. These activities will continue to focus on its strong future markets and developing innovative products that solve the industrial challenges faced by customers with a focus on developing applications for hybrid and electromobility, but also in the area of water management.

ADJUSTED EBITA MARGIN

An important focus of NORMA Group is on maintaining its high profitability. Therefore, all business activities are strategically aligned to achieve this goal. In February 2019, the Management Board announced a rightsizing program to prepare NORMA Group for further growth as effectively as possible. ► **STRATEGIC OUTLOOK FOR FISCAL YEAR 2019, P. 44** As part of this program, the internal structures that have grown quickly in recent years, due in part to acquisitions, are to be harmonized and optimized. As part of these efforts, several projects are planned that will cover all regions over a period of approximately two years. These optimization measures should result in a positive earnings contribution of around EUR 10 million to EUR 15 million per year from 2021 onwards and will serve to restore NORMA Group to its usual high level of profitability in the medium term. The implementation of these measures, with a planned total cost volume of around EUR 10 million to EUR 15 million, is expected to take place over a

period of around two years, of which around EUR 2.2 million was already incurred in the past fiscal year. These costs are shown on an adjusted basis.

► **ADJUSTMENTS, P. 141**

Due to the above mentioned challenges on the purchasing side, which are likely to improve, but not completely come to an end, over the course of the year, but also the volatile economic and political framework conditions and risks in connection with the Brexit, NORMA Group's Management Board expects the adjusted EBITA margin to be between 15% and 17%.

NORME VALUE ADDED (NOVA)

For fiscal year 2019, the Management Board assumes a NOVA between EUR 50 million and EUR 60 million.

FINANCIAL RESULT OF UP TO EUR – 15 MILLION EXPECTED

The Management Board expects a financial result of up to EUR – 15 million in total for 2019. This includes interest charges on the Group's gross debt with an average interest rate of approx. 2.5% as well as other expenses for currency hedges and transaction costs.

TAX RATE OF BETWEEN 25% AND 27%

Due to the tax cuts in the US that already took place in 2017, the Management Board expects a tax rate of between 25% and 27% for fiscal year 2019.

MODERATE INCREASE IN ADJUSTED EARNINGS PER SHARE

Based on the developments described above, the Management Board of NORMA Group expects to see a moderate increase in adjusted earnings per share in fiscal year 2019.

ADJUSTMENTS TO THE RESULT

In fiscal year 2019, NORMA Group's Management Board expects adjustments in the allocation of purchase prices to depreciable tangible and intangible assets from the acquisitions of the past years in the amount of around EUR 25 million. Furthermore, the one-time expenses incurred as part of the rightsizing project in the amount of approximately EUR 8 million to EUR 13 million are shown on an adjusted basis. In total, the Management Board expects adjustments of between EUR 33 million and EUR 38 million in total.

INVESTMENT RATE OF AROUND 5% THE TARGET

For fiscal year 2019, NORMA Group's Management Board expects investments in the operating business of around 5% of Group sales. This covers both maintenance investments and investments in expanding the business. A particular focus will be on the expansion of activities for future growth, projects for the



37 Principles of the Group

51 Economic Report

74 Forecast Report79 Risk and
Opportunity Report

91 Remuneration Report

98 Other Legally
Required Disclosures101 Report on Transactions
with Related Parties

integration of processes and functions (insourcing) as well as the expansion of capacities for the localization of production.

NET OPERATING CASH FLOW

Due to the fact that sales growth is expected to be less dynamic in fiscal year 2019, but also due to the continuing burdens on the purchasing side, the Management Board expects net operating cash flow to be around EUR 100 million assuming a constant investment ratio.

SUSTAINABLE DIVIDEND POLICY

If the future economic situation permits, NORMA Group will pursue a sustainable dividend policy, which is based on a dividend ratio of approx. 30% to a maximum of 35% of the adjusted Group annual earnings.

MARKET PENETRATION AND INNOVATION CAPABILITY

The degree of market penetration is reflected in medium-term organic growth. Ensuring the ability to innovate is essential for the future competitiveness of NORMA Group. NORMA Group records the number of invention applications per year as an indicator for measuring and managing the Company's innovative strength. More than 20 new invention applications are targeted each year for the Group.

EMPLOYEE PROBLEM-SOLVING BEHAVIOR

NORMA Group measures and manages problem-solving behavior, among other topics, based on the number of customer complaints, by using the following two performance indicators: effective parts (parts per million, PPM) rejected by the customer and the number of quality-related complaints. For the PPM indicator, a value of less than 20 is the target each year until 2020 depending on the product group. Customer complaints are also to be further reduced to fewer than 8 per month on an annual average.

SUSTAINABLE COMPANY DEVELOPMENT

NORMA Group has published its CR Roadmap 2020. The objective of the Group is to continue to achieve the goals and measures stated therein in a consistent manner and lay even more important milestones for managing the Company more sustainably in the current year.

T 029 FORECAST FOR THE FISCAL YEAR 2019¹

Group sales growth	Moderate organic growth of around 1% to 3%, additionally around EUR 13 million from acquisitions
	EMEA: moderate organic growth Americas: moderate organic growth APAC: strong organic growth DS: moderate growth EJT: moderate growth
Adjusted cost of materials ratio	Roughly at the same level as in previous years
Adjusted personnel cost ratio	Roughly at the same level as in previous years
Investments in R&D (in relation to EJT sales)	Around 5% of EJT sales
Adjusted EBITA margin	Between 15% and 17%
NOVA	Between EUR 50 million and EUR 60 million
Financial result	Up to EUR –15 million
Tax rate	Around 25% to 27%
Adjusted earnings per share	Moderate increase
Investment rate (without acquisitions)	Operative investments of around 5% of Group sales
Net operating cash flow	Around EUR 100 million
Dividend/dividend ratio	Approx. 30% to 35% of adjusted net profit for the period
Number of invention applications	More than 20
Number of defective parts (parts per million/PPM)	Below 20 ²
Number of quality-related complaints per month	Below 8 ²

¹ Changes in key figures resulting from the first-time application of IFRS 16 are not taken into account in the forecast.

² Targets until 2020



- 37 Principles of the Group
- 51 Economic Report
- 74 Forecast Report
- 79 Risk and Opportunity Report**
- 91 Remuneration Report
- 98 Other Legally Required Disclosures
- 101 Report on Transactions with Related Parties

RISK AND OPPORTUNITY REPORT

NORMA Group is exposed to a wide variety of risks and opportunities, which can have a positive or negative short-term or long-term impact on its financial, assets and earnings position. For this reason, opportunity and risk management represents an integral component of corporate management for NORMA Group SE, at both the Group management level and at the level of the individual companies and individual functional areas. Due to the fact that all corporate activities are associated with risks and opportunities, NORMA Group considers identifying, assessing, and managing opportunities and risks to be a fundamental component of executing its strategy, securing the short and long-term success of the Company and sustainably increasing shareholder value. In order to achieve this over the long-term, NORMA Group encourages its employees in all areas of the Company to remain conscious of risks and opportunities.

RISK AND OPPORTUNITY MANAGEMENT SYSTEM

NORMA Group defines risks and opportunities as possible future developments, changes, or events that could have a positive or negative impact on the Group's ability to meet its targets and achieve its business objectives. Analogous to the medium-term planning, the management's focus with respect to possible deviations in specific risks and opportunities covers a period of five years. Opportunities and risks that affect the Company's success beyond this period of time are recorded and managed at the Group management level and taken into consideration in the Company's strategy. Analogous to the medium-term planning, the focus with respect to the valuation of specific risks and opportunities covers a period of five years, provided that no other period is specified in the individual categories.

The Management Board of NORMA Group SE is responsible for maintaining an effective risk and opportunity management system. The Supervisory Board is responsible for monitoring the effectiveness of the Group's risk management system. Compliance with the Group's risk management policy in the individual companies and functional areas is subject to the internal audit department's periodic reviews.

RISK MANAGEMENT PROCESS

The risk management process at NORMA Group includes the core elements of risk identification, risk assessment and risk controlling and monitoring. The risk management process has been fully integrated into an integrated software solution. The respective units record the identified and assessed risks. Subsequently, the regional risk officers and, depending on the risk category, the functional

managers at Group level, check and approve the respective risks with the help of the software. The process of identifying, evaluating and controlling risks is accompanied by continuous monitoring and communication of the reported risks by the risk managers.

G 026 RISK MANAGEMENT SYSTEM OF NORMA GROUP



Risk identification is carried out bottom-up by the individual companies as well as top-down by the individuals responsible for functions at the regional and Group level. Various methods that correspond to the structure of the organization are used to identify risks. Such methods include interdisciplinary workshops, interviews and checklists, but also market and competition analyses. In certain cases, analyses of the process workflows as well as results from internal and external audit reports are used. NORMA Group's risk managers are responsible for verifying on a regular basis whether all material risks have been captured.

NORMA Group uses a systematic assessment procedure to evaluate the risks that were identified, both in terms of their financial impact and probability of occurrence. All risks that can be adequately assessed and specified are reported regardless of their expected financial impact. The measurement of the gross expectation value of the risk, i.e. the expected value of the risk before consider-

37	Principles of the Group
51	Economic Report
74	Forecast Report
79	Risk and Opportunity Report
91	Remuneration Report
98	Other Legally Required Disclosures
101	Report on Transactions with Related Parties

ing countermeasures, must be based on the assumption of the most unfavorable outcome of the financial impact for the Company.

As part of the risk controlling, the appropriate risk mitigating measures are developed, implemented and their implementation is monitored. These include, in particular, strategies to avoid, reduce and secure risks, i.e. measures that minimize the financial impact of the risks as well as their probability of occurrence. Risks are managed in accordance with the principles of the risk management system as described in the Group risk management policy.

Risk reporting

Group-wide recording and assessment of risks as well as their reporting to the functional managers and individual companies by functional areas, the management of the segments, the Management Board and the Supervisory Board takes place on a quarterly basis. In addition, risks that are identified within a quarter and whose expected value have a significant impact on the results of subgroups of the Group are reported ad hoc to the Management Board and, if necessary, to the Supervisory Board.

In order to analyze NORMA Group's overall risk situation and initiate suitable countermeasures, individual risks of local business units, segments and Group-wide risks are aggregated in a risk portfolio. All entities, which are included in NORMA Group's Consolidated Financial Statements, are part of the Company's risk reporting and risk management process. In addition, NORMA Group categorizes risks according to type and the functional area they affect. This makes it possible to aggregate individual risks into risk groups in a structured manner. This aggregation enables NORMA Group to identify and manage not only individual risks, but also trends and Company-specific types of risks and thus sustainably influence and reduce the risk factors with certain types of risks. If not indicated otherwise, the risk assessment applies for all regional segments.

OPPORTUNITY MANAGEMENT PROCESS

Operational opportunities are identified during monthly meetings held at the local and regional level, but also by the Management Board, and then documented and analyzed. Measures aimed at capitalizing on strategic and operational opportunities through local and regional projects are approved during these meetings. Regular forecasts are developed as part of periodic reporting to record how successfully potential opportunities are taken advantage of. Strategic opportunities are recorded and evaluated as part of annual planning. NORMA Group uses a systematic assessment procedure to evaluate the opportunities and risks that were identified, both in terms of their financial impact, i.e. gross and net impact on planned financial indicators, and their probability of occurrence.

INTERNAL CONTROL AND RISK MANAGEMENT SYSTEM WITH REGARD TO THE GROUP ACCOUNTING PROCESS

NORMA Group's internal control and risk management system with regard to the Group accounting process can be described using the following main characteristics: The purpose of this system is to identify, analyze, evaluate and manage risks as well as monitor these activities. The Management Board is responsible for ensuring that this system meets the Company's specific requirements. Based on the allocation of responsibilities within the Company, the CFO is responsible for the Finance and Accounting divisions. These functional areas define and review the Group-wide accounting standards within the Group and compile the information used to produce the Consolidated Financial Statements. The need to provide accurate and complete information within predefined timeframes represents a significant risk for the accounting process. Because of this, requirements must be clearly communicated and the affected units must be put in a position to meet these requirements.

Risks that may affect the accounting process arise, for example, from the late or incorrect recording of business transactions or non-compliance with accounting rules. The failure to enter business transactions also represents a potential risk. In order to avoid errors, the accounting process is based on the segregation of duties and functions and plausibility checks for reporting. The preparation of the financial statements of those entities to be included in the Consolidated Financial Statements as well as the consolidation measures based on this consolidated group are characterized by consistent observance of the 'four eyes-principle'. Comprehensive and detailed checklists must be completed before the respective reporting deadlines. The accounting process is fully integrated into NORMA Group's risk management system. This ensures that accounting risks are identified at an early stage, allowing the Company to implement measures for risk prevention and risk mitigation without delay.

The internal control system ensures the accuracy of NORMA Group's financial reporting with respect to its accounting processes. The internal audit department reviews the accounting processes on a regular basis to ensure that the internal control and risk management system is effective. External specialists also support these efforts. Furthermore, the financial statement auditor conducts audit procedures during the audit of the annual financial statements based on the risk-based audit approach, whereby material errors and violations are to be uncovered with reasonable assurance.

The IFRS accounting standards as they are to be applied in the European Union are summarized in an accounting manual that includes an account assignment guideline. All companies in the Group must base their accounting processes on

37 Principles of the Group

51 Economic Report

74 Forecast Report

**79 Risk and
Opportunity Report**

91 Remuneration Report

98 Other Legally
Required Disclosures101 Report on Transactions
with Related Parties

the standards described in the accounting manual. Important accounting and valuation standards, such as the recognition and measurement of fixed assets, inventories and receivables, as well as provisions and liabilities, are defined as binding. The Group also has system-supported reporting mechanisms to ensure that identical situations are handled in a standardized way across the Group.

The Consolidated Financial Statements and Group Management Report are prepared according to a uniform time schedule for all companies. Each company in the Group prepares its separate financial statements in accordance with the applicable local accounting guidelines and IFRS. Intra-Group deliveries and services are recorded in separately designated accounts by the Group companies. The net balances of Intra-Group offsetting accounts are reconciled on the basis of defined guidelines and schedules by means of balance confirmations. The companies in the Group use the COGNOS reporting system for financial reporting. In accordance with NORMA Group's regional segmentation, technical responsibility for the financial area is shared by both the financial officers in the Group companies as well as by the regional CFO for the respective segment. They are responsible for the quality assurance of the financial statements of the respective Group companies. The comprehensive quality assurance of the financial statements of the Group companies included in the Consolidated Financial Statements is carried out by Group Accounting, Finance & Reporting, which is responsible for preparing the Consolidated Financial Statements. In addition, the data and disclosures of the Group companies as well as the consolidation measures necessary for the preparation of the Consolidated Financial Statements are verified through audit procedures conducted by external auditors under consideration of the associated risks.

The various IT systems that individual NORMA Group companies use to perform financial accounting are gradually standardized. Tiered user access rights are defined for all systems. The type and design of these access authorizations and authorization policies are decided on by local management in coordination with NORMA Group's central IT department.

RISK AND OPPORTUNITY PROFILE OF NORMA GROUP

As part of the preparation and monitoring of its risk and opportunities profile, NORMA Group assesses risks and opportunities based on their financial impact and their probability of occurrence. The financial impact of risks and opportunities are assessed based on their relation to EBITA. The following five categories are used here:

- ▶ Insignificant: up to 1% of current EBITA
- ▶ Minor: more than 1% and up to 5% of current EBITA
- ▶ Moderate: more than 5% and up to 10% of current EBITA
- ▶ Significant: more than 10% and up to 25% of current EBITA
- ▶ High: more than 25% of current EBITA

The interval of the risk's or the opportunity's impact generally relates to the EBITA of the Group. Provided that an individual assessment relates solely to a specific segment, the EBITA of the respective segment is used instead. The assessment of opportunities and risks whose financial impact has an effect on line items in the Statement of Comprehensive Income below EBITA is also performed in relation to EBITA. The presented impact always reflects the effects of countermeasures initiated.

The probability of individual risks and opportunities occurring is quantified based on the following five categories:

- ▶ Very unlikely: up to 3% probability of occurrence
- ▶ Unlikely: more than 3% and up to 10% probability of occurrence
- ▶ Possible: more than 10% and up to 40% probability of occurrence
- ▶ Likely: more than 40% and up to 80% probability of occurrence
- ▶ Very likely: more than 80% probability of occurrence

FINANCIAL OPPORTUNITIES AND RISKS

NORMA Group is exposed to several financial risks, including default, liquidity and market risks. The Group's financial risk management strategy concentrates on the identification, evaluation and mitigation of risks, focusing on minimizing the potential negative impact on the Company's financial, asset and earnings position. Derivative financial instruments are used to hedge particular risk items. The financial risk management is carried out by Group Treasury. The management defines the areas of responsibility and necessary controls related to the risk management strategy. Group Treasury is responsible for defining, evaluating and hedging financial risks in close consultation with the Group's operating units. In this context, various processes and organizational structures work together to measure and evaluate opportunities and risks on a regular basis, and

37	Principles of the Group
51	Economic Report
74	Forecast Report
79	Risk and Opportunity Report
91	Remuneration Report
98	Other Legally Required Disclosures
101	Report on Transactions with Related Parties

to initiate appropriate measures if necessary. Group Treasury regularly conducts analyses of default risks, interest rate risks, currency risks and liquidity risks. The results are then discussed internally and actions are defined. Group Treasury also advises the management of relevant departments in monthly committee meetings and discusses how to handle these risks and the potential impact on NORMA Group. ► **NOTES, P. 136**

Capital risk management

NORMA Group's objective when it comes to managing its capital is primarily the long-term servicing of its debts and remaining financially stable. In connection with its financing agreements, the Company is obliged to maintain the financial covenant total net debt cover (debt divided by adjusted consolidated EBITDA). This key figure and its maintenance, but also net debt and the maturity structure of financial debt, are continually monitored. Changes in the value of the amounts included in this financial indicator are limited by employing long-term hedging strategies.

Default risks

Default risks are risks of contractual partners not meeting their obligations arising from business and financial transactions. Due to the nature of the respective assets and business relationships, as well as the soundness of its current banking partners, default risks with respect to deposits and other transactions concluded with credit and financial institutions currently do not represent a major risk category for NORMA Group. Nevertheless, the creditworthiness of contract partners is continuously monitored and discussed at regular senior management meetings.

Relevant default risks can arise, however, with respect to business relationships with customers and relate to outstanding receivables and committed transactions. NORMA Group reviews the creditworthiness of new customers to minimize the risk of default on trade receivables. Customers whose credit ratings are below Group standards or who have defaulted on payment are only supplied if they pay in advance. Additionally, a diversified customer portfolio reduces the financial repercussions of default risks. Default risks are still considered to be unlikely due to the measures referred to above. The potential financial effects of default risks are judged to be insignificant considering the relevant factors, such as bad debt losses experienced in the past, and due to the countermeasures taken.

Liquidity opportunities and risks

Prudent liquidity risk management requires NORMA Group to hold sufficient cash funds and marketable securities, have sufficient financing from committed lines of credit and be able to close out market positions. Due to the dynamic nature of the underlying business, Group Treasury aims to maintain flexibility in financing by keeping committed credit lines available. Therefore, NORMA Group's primary objective is to ensure the uninterrupted solvency of all Group companies. Group Treasury is responsible for liquidity management and therefore for minimizing liquidity risks. As of December 31, 2018, NORMA Group's liquid assets (cash and cash equivalents) amounted to EUR 190.4 million (2017: EUR 155.3 million). Furthermore, NORMA Group has a high level of financial flexibility thanks to a committed revolving credit line with national and international credit institutions in the amount of EUR 50 million. This line was not drawn down at all as of December 31, 2018. In addition, NORMA Group has a so-called accordion facility of up to EUR 148 million at its disposal, as well as a credit line of EUR 15 million that has not been formally approved but negotiated, that offer additional financial scope.

Financial opportunities are seen, among other areas, in NORMA Group's high creditworthiness as well as its solid financial, assets and earnings position, which enable the Company to gradually reduce its capital costs. Against this backdrop, NORMA Group repaid part of the promissory note issued in 2014 and the loan negotiated in 2015 in the past fiscal year on schedule without raising new or additional funds for this purpose. In addition, two subsidiaries were acquired in the past fiscal year by using the negotiated accordion facility – without increasing the margin requirements of the financing banks. The liquidity-related opportunities are considered likely, in particular due to the positive assessment by the banking partners and the resulting reputation on the capital market. In light of the refinancing measures carried out in the recent past, by which the borrowing costs have already been reduced quite considerably, the potential financial effects of liquidity-related opportunities on NORMA Group's earnings are considered to be only minor. ► **FINANCIAL POSITION, P. 62**

Most of the Group's financing agreements contain typical terms for credit lines (financial covenants). If NORMA Group does not adhere to these terms, the banks would be entitled to re-evaluate the agreements and demand early repayment. Failure to comply with these loan covenants would have high potential financial repercussions. For this reason, NORMA Group continuously monitors its compliance with the financial covenants in order to implement suitable measures in advance and prevent the terms from being violated. In order to hedge balance positions in foreign currencies whose valuation leads to fluctuations in the profit and loss account, NORMA Group partly uses rolling hedging transactions. Group Treasury ensures that sufficient liquidity or granted credit lines are

37	Principles of the Group
51	Economic Report
74	Forecast Report
79	Risk and Opportunity Report
91	Remuneration Report
98	Other Legally Required Disclosures
101	Report on Transactions with Related Parties

available at all times to cover possible cash outflows related to these hedging measures. This is continuously monitored by means of risk simulation and discussed in senior management meetings. The probability of liquidity risks having a negative impact on NORMA Group's activities is very unlikely given the high level of financial flexibility provided by committed and unused bank credit lines. The risk of non-compliance with financial covenants is still considered very unlikely due to high profitability and a strong operating cash flow. In the event of (short-term) increased liquidity requirements that exceed currently negotiated lines, the possibilities of raising funds at market conditions are considered to be very good.

Foreign currency trends

As an internationally operating Company, NORMA Group is active in more than 100 countries and is thus exposed to foreign currency risks. The US dollar, British pound, Swiss franc, Chinese renminbi, Polish zloty, Swedish krona, Czech koruna, Singapore dollar, Indian rupee and Serbian dinar are regarded to be the main risk-prone currency positions.

Foreign currency risks that cannot be offset against each other are hedged using futures and options whenever reasonable. The high volatility of many major currencies and the particular influence of the US dollar on the Group's financial, assets and earnings position represent a considerable risk that can only be partially hedged for a short-term period. In the medium term, NORMA Group reduces foreign currency risks by increasing regional production. ► **PRODUCTION AND LOGISTICS, P. 65**

Because the Group's subsidiaries operate in the most important countries with currencies other than the euro, it has sufficient cash-in and cash-out capabilities to absorb short-term exchange rate fluctuations via targeted income and expenditure management. The optimization of the bank loans renegotiated in 2015, which now also offers the possibility of utilizing credit lines in US dollars, but also the promissory note tranches issued in US dollars in 2016, results in more congruent payment profiles in US dollars. In addition, currency risk is monitored in the Group and transferred to the euro over time on a rolling basis by means of derivative hedging instruments if the risk becomes too excessive. Translation risks are continuously monitored by Group Treasury. Translation effects from items in the Statement of Financial Position and income statement of subsidiaries in foreign currency areas on the Consolidated Statement of Financial Position prepared in euros are unavoidable, however.

The potential financial effects of opportunities and risks related to exchange rate changes are considered to be moderate based on the sensitivity analyses that have been performed. The probability of the incidence of these risks and opportunities is assessed to be possible in light of recent exchange rate fluctuations and the uncertainties with regard to the further development of relevant exchange rates.

Changes in interest rates

Changes in global market interest rates affect future interest payments for variable interest liabilities and can therefore have an adverse effect on the Group's financial position, financial performance and cash flows. NORMA Group's interest change risk arises in particular from long-term loans.

Many of the current loans have fixed interest rates and are therefore not subject to interest rate risk. ► **GOALS REGARDING FINANCE AND LIQUIDITY MANAGEMENT, P. 47**

Loans that initially had variable interest rates were partly synthetically converted into fixed interest rate positions using derivative instruments. NORMA Group has hedged over 90% of its variable interest rate loans in USD valued at USD 160 million in total. On the other hand, variable rate loans denominated in euros in the amount of EUR 177 million are for the most part unhedged.

Due to the fact that there are currently no signs of a more restrictive monetary policy in the euro region, NORMA Group regards the risk of interest rate hikes in the short term to be rather unlikely; however, the risk of higher interest rates is considered to be possible in the medium term. This would only have a minor financial impact due to NORMA Group's financing structure, however. Due to the currently low interest rate level, the potential for opportunities that can arise from a falling interest rate level is considered to be unlikely. In light of the measures already implemented on optimizing financing, the financial effects associated with these opportunities are considered to be insignificant.

37	Principles of the Group
51	Economic Report
74	Forecast Report
79	Risk and Opportunity Report
91	Remuneration Report
98	Other Legally Required Disclosures
101	Report on Transactions with Related Parties

ECONOMIC AND CYCLICAL OPPORTUNITIES AND RISKS

The success of NORMA Group depends significantly on macroeconomic trends on its sales markets and its customers' sales markets. Therefore, indicators for economic development worldwide are taken into account both in planning as well as in risk and opportunities management. In order to gauge the macroeconomic trend, NORMA Group mainly uses the forecasts of widely regarded institutions such as the IMF, the Bundesbank and reputable economic research institutes. Accordingly, global growth of 3.5 % can be expected in 2019.

In the previous year, the uncertain outcome of the Brexit process and rising bond yields due to increasing protectionism were identified as key risk factors with regard to the economic development. In addition, a flattening of the pace of expansion of the Chinese market and turbulences on the global currency and capital markets were seen as additional possible risks. For the current fiscal year, a disorderly Brexit process, an even stronger economic downturn in China, the intensification and expansion of protectionism and other geopolitical crises can be considered relevant risk factors. Furthermore, the high national debt in Italy and France could have a negative impact on the economic development in Europe.

In light of the possible overall economic impact of these developments, NORMA Group is of the opinion that a negative development of the global economy compared to the planning assumptions is currently classified as possible taking these risks into account. Should these factors lead to a deterioration in global demand, the financial deviations from planning are considered to be moderate. A positive development of the global economy that goes beyond the planning assumptions represents an opportunity for NORMA Group. Thanks to its flexible production structures, NORMA Group is able to expand capacities in the short term and thus respond to a generally increased demand. The Company believes it is unlikely (previous year: possible) that the global economic situation and thus NORMA Group's earnings will improve beyond the planning assumptions. In the overall view of the current macroeconomic climate and the prospects based thereon, the potential financial impact of these opportunities is considered minor as in the previous year.

**INDUSTRY-SPECIFIC AND TECHNOLOGICAL
RISKS AND OPPORTUNITIES**

Industry-specific and technological opportunities and risks for NORMA Group are closely linked to the conditions and developments in the respective customer industries. ► **PRODUCTS AND END MARKETS, P. 40** It should be borne in mind that the customer industries in the regions relevant to NORMA Group, EMEA, the Americas and Asia-Pacific, have partly specific characteristics and challenges.

Business activities with OEMs for passenger cars and commercial vehicles as well as customers in the aftermarket segment still represent the most important end markets for NORMA Group. In this area, the ever-stricter emission standards as well as the increasing use of more environmentally friendly drive technologies represent a development that is associated with various opportunities and risks for NORMA Group. NORMA Group's current product portfolio includes a variety of solutions that help reduce emissions in passenger cars and commercial vehicles equipped with an internal combustion engine, including hybrid vehicles, and thus help customers meet ever-stricter emission requirements. The Company's current solutions are constantly being developed further and supplemented by sustainable innovations as required. NORMA Group is also in a good position to meet the challenges of ever more relevant electromobility through its future-proof product portfolio. For example, solutions from NORMA Group's current product portfolio are already being used in purely battery-powered electric vehicles. Regulatory measures such as stricter exhaust gas standards and the resulting increased demand for environmentally friendly technologies and products are thus an opportunity for NORMA Group. Should the proportion of purely battery-powered electric vehicles increase further in the future, it will be important for NORMA Group to be able to continue offering suitable, innovative product solutions in this dynamic environment. Accordingly, the ongoing discussion about compliance with emission standards in vehicles with an internal combustion engine may also pose risks for NORMA Group. NORMA Group counteracts these risks with its ongoing initiatives to secure and expand its technology and innovation leadership, as well as by focusing on customers and markets. ► **RESEARCH AND DEVELOPMENT, P. 48**

The water management segment, which has been consistently strengthened by the acquisitions carried out in past years, represents another strategically important customer industry for NORMA Group. The increasing scarcity of water and the responsible handling of this important resource in this context are leading to business opportunities.

NORMA Group's strong diversification in terms of customers in different industries is another element of the Company's risk and opportunity management.

INTRODUCTION

OUR VISION

TO OUR SHAREHOLDERS

**CONSOLIDATED
MANAGEMENT REPORT**

CONSOLIDATED
FINANCIAL STATEMENTS

FURTHER INFORMATION

37 Principles of the Group

51 Economic Report

74 Forecast Report

**79 Risk and
Opportunity Report**

91 Remuneration Report

98 Other Legally
Required Disclosures

101 Report on Transactions
with Related Parties

NORMA Group counters long-term, industry-specific risks and opportunities through a consistent innovation policy and regular market analyses.

In summary, the industry-specific and technological opportunities and risks are assessed to be possible with a moderate financial impact.

RISKS AND OPPORTUNITIES ASSOCIATED WITH CORPORATE STRATEGY

The strategic goal of NORMA Group is to achieve a sustained increase in the Company's value. In view of this goal, NORMA Group is pursuing the strategy of profitably expanding its business activities through organic growth as well as selective value-enhancing acquisitions and achieving broad diversification with respect to its products, regions and end markets, thus becoming less dependent on individual products, regions and end markets. NORMA Group's aim is to grow with innovations, superior product quality and strong brands in existing end markets, to open up new end markets and to continuously improve the efficiency of its business processes in all functional areas and regions. ► **GOALS AND STRATEGY, P. 42**

Besides the Company's strategic activities aimed at continuing to develop the business organically, NORMA Group sees considerable opportunities to increase the Group's financial result beyond planning, particularly in its strategy of profitably expanding its business activities through selective, value-adding acquisitions. NORMA Group has been able to demonstrate the success of this strategy several times in the past by completing its acquisitions. If, however, in individual cases, the development of the acquired companies falls behind the expectations at the time of acquisition or if integration progresses more difficultly than assumed, risks could also arise from acquisitions for NORMA Group. However, NORMA Group believes that the Company's goals for the profitability of potential acquisitions, careful due diligence measures in the run-up to the acquisition, and agreed integration plans form the basis for mitigating these risks accordingly.

In addition, opportunities to achieve its financial targets arise for NORMA Group from the broad diversification with respect to its products, regions and end markets. Should the demand in individual regions and end markets or the demand for individual products temporarily lag behind planning, NORMA Group will have the chance to compensate for this via other regions, end markets or products. Nevertheless, the broad diversification with respect to products, regions and end markets also implies a certain complexity, which can be associated with risks for NORMA Group. Because NORMA Group's diversification efforts are being carried out step by step with regard to the regions and end markets as well as its products, these risks can be adequately limited by means of an appropriate adaptation of the organization to the changed circumstances.

With respect to the efficiency of its business processes, NORMA Group is able to settle production processes that require a higher degree of manual assembly effort in countries with lower labor costs, thus securing and further increasing its profitability. However, there are inevitably risks associated with the appropriate location decisions and related investments if significant assumptions made in the investment decision are not fulfilled. NORMA Group addresses these risks by conducting careful analyses in the run-up to investment decisions and uses graded approval procedures.

When the corporate strategy initiatives of NORMA Group are combined, the financial impact of the opportunities associated with NORMA Group's Company strategy is assessed as moderate and a positive deviation from planning as possible. Based on the measures taken to limit the risks associated with NORMA Group's corporate strategy, the probability of the occurrence of strategic risks is considered unlikely, while the potential financial impact of corporate strategy risks is considered moderate.

The Company strategy is adapted to the individual market conditions in the individual segments. For instance, acquisitions are made particularly in those countries and regions that offer attractive growth opportunities for NORMA Group. Nevertheless, the general assessment of corporate strategy opportunities and risks in the regions is identical.



37	Principles of the Group
51	Economic Report
74	Forecast Report
79	Risk and Opportunity Report
91	Remuneration Report
98	Other Legally Required Disclosures
101	Report on Transactions with Related Parties

OPERATIONAL RISKS AND OPPORTUNITIES**Commodity prices**

The materials that NORMA Group uses, in particular the raw materials steel and plastics, are subject to the risk of price fluctuations. The price trend is also influenced indirectly by the further development of the world economic situation as well as by institutional investors. NORMA Group limits the risk of rising purchase prices through systematic material and supplier risk management. Thanks to a powerful global Group purchasing structure, economies of scale are being used to purchase the most important product materials steel, metal components, polyamides and rubber as competitively as possible. This Group purchasing structure also enables NORMA Group to balance out the risks of individual segments with each other. NORMA Group also constantly strives to secure permanently competitive procurement prices by continuously optimizing its selection of suppliers and applying the best-landed-cost-approach. The Company also tries to reduce dependency on individual materials through constant technological advances and tests of alternative materials. Protection against commodity price volatility is done by forming procurement contracts with a term of up to 24 months, whereby material supply risks are minimized and price fluctuations can be better calculated.

With regard to the procurement of steel and metal components, the increasing protectionism that is particularly noticeable in North America is leading to a sharp rise in procurement prices. Potential economic policy responses in Europe and Asia, especially in China, could lead to a further increase in procurement prices. The price component of alloy surcharges relevant to the purchasing of stainless steel is still seen as volatile, whereby an increase can be expected in the medium and long term. In the area of engineering plastics, NORMA Group was faced with rising purchasing prices in the past fiscal year. Several incidents that can be classified as force majeure occurred in the past fiscal year and led to significant shortages on the market for PA 6.6. Due to the expected continued high demand for this product group, NORMA Group considers the probability of rising prices to be likely. Overall, the rise in commodity prices is estimated to be likely. Due to the countermeasures initiated, however, only minor financial effects are expected, as a share of the commodity price increases can be passed on to the customer by renegotiating contracts.

Similarly, the opportunities arising from declining raw material prices are also considered to be minor in terms of their financial impact. Especially in light of the continuing protectionist tendencies in trade policy, as was the case last year, it can be considered unlikely that global commodity prices will fall short of the planned levels, due to the currently rising prices for steel, metal components and polyamides/engineering plastics.

Suppliers and dependencies on key suppliers

The loss of suppliers and dependencies on single suppliers can lead to material shortages and thus to negative impacts on the Group's activities. In order to minimize this risk, NORMA Group only works with reliable and innovative suppliers who meet its high quality requirements. In the area of production material, the ten most important suppliers are responsible for approximately 33% of the purchasing volume. ► **PURCHASING AND SUPPLIER MANAGEMENT, P. 67** These and other key suppliers are regularly observed and assessed as part of quality management. If the loss of a supplier appears imminent, NORMA Group evaluates alternatives immediately. As a result, the loss of suppliers is considered possible, but the potential financial impact is regarded as minor. However, NORMA Group also sees opportunities in this area as a result of its proactive approach both in terms of existing supplier relationships as well as identification of new suppliers and raw materials. But since an optimization in the area of purchasing is anticipated in the medium term, NORMA Group estimates the potential of the implemented measures for a positive deviation from planning to be possible with a minor impact.

Quality and processes

NORMA Group's products are often mission-critical with respect to the quality, performance and reliability of the final product. Quality defects can lead to legal disputes, liability for damages or the loss of a customer. Therefore, the reliable guarantee of product quality is a key factor to ensuring NORMA Group's long-term success, so that its products provide crucial added value for its customers. ► **QUALITY MANAGEMENT, P. 66** Maintaining the right balance between cost leadership and quality assurance is a constant challenge. To reduce this risk, far-reaching quality assurance measures and uniform Group-wide quality standards are used. Furthermore, NORMA Group focuses on innovative and value added joining solutions tailored to meet customer requirements. For this reason, the Company believes that it is possible for quality risks to occur, while the potential financial repercussions would be minor due to the existing insurance coverage.

37	Principles of the Group
51	Economic Report
74	Forecast Report
79	Risk and Opportunity Report
91	Remuneration Report
98	Other Legally Required Disclosures
101	Report on Transactions with Related Parties

NORMA Group takes every opportunity to realize cost advantages to improve its competitive position. The Company develops and implements initiatives focused on cost discipline, the continuous improvement of processes in all functions and regions and the optimization of supply chain management and production processes. These initiatives are expected to have a positive impact on NORMA Group's business. ► **PRODUCTION AND LOGISTICS, P. 65** Since NORMA Group pursues a continuous process of improvement, there are opportunities over and above planning for positive deviations in the area of these processes. This applies for all regions in which NORMA Group is active. The Company estimates the likelihood of cost savings to be possible. Since planning already allows for continuous optimization of production processes and NORMA Group's processes are already extremely efficient, the short-term financial impact of a deviation from the plan as a result of improved production processes is minor.

Customers

Customer risks result from a company being dependent on important buyers for a significant proportion of its sales. They could take advantage of their bargaining power, which can lead to increased pressure on the Company's margins. Decreases in demand from these customers or the loss of these customers can have a negative impact on the Company's earnings. For this reason, NORMA Group continuously monitors incoming orders and customer behavior so as to identify customer risks early. Due to its diversified customer portfolio, financial repercussions of customer risks are reduced. Accordingly, no single customer accounted for more than 5% of sales in fiscal year. Therefore, it is possible that customer risks could have a negative impact on NORMA Group's business, but the financial effects would be minor due to the diversified customer structure.

Based on NORMA Group's strategy and the goal of further expanding its markets, the Company managed to expand its customer portfolio compared to the previous year. Innovative solutions were used to gain new customers for NORMA Group products throughout all regions. Therefore, NORMA Group estimates the opportunities for positive deviations from planning to be possible with a minor impact on earnings based on a growing number of customers.

RISKS AND OPPORTUNITIES OF PERSONNEL MANAGEMENT

NORMA Group's success is largely dependent on its employees' enthusiasm, commitment to innovation, expertise and integrity. The Group's personnel management serves to retain and expand this core expertise. The resignation of employees with crucial skills as well as a shortage of suitable workers can have a negative impact on operations. The competition for the most talented employees as a result of demographic developments and the shortage of skilled labor in Western industrial nations is becoming more and more intense.

NORMA Group counters these risks with far-reaching basic and advanced training as well as employee development programs. NORMA Group also encourages its employees to focus on the Company's success through variable remuneration systems. In return, the employees contribute to the continuous further development of the Company in connection with employee surveys and improvement initiatives. Comprehensive representation rules and a division of responsibilities that promote mutual exchange secure the Group from risks that can arise due to the departure of employees. When identifying potential new employees who can make a crucial contribution to performance, NORMA Group seeks the advice of external human relations advisors.

Thus, the Company regards the probability of personnel risks occurring as possible, whereas the potential financial impact is insignificant due to the sustainable personnel policy.

In addition, there are opportunities from the consistent further development of employees. NORMA Group fosters its employees and offers them incentives to further develop their personal expertise through educational and training opportunities as well as the targeted search for talent within the Group. Furthermore, NORMA Group offers its employees flexible and family-friendly working time models. Through the above-mentioned measures, NORMA Group actively supports the preservation and collection of knowledge within the Company, which will thus offer opportunities for the future development of NORMA Group. The occurrence of these opportunities is considered likely, whereby the associated financial success is considered to be minor.



37 Principles of the Group

51 Economic Report

74 Forecast Report

**79 Risk and
Opportunity Report**

91 Remuneration Report

98 Other Legally
Required Disclosures

101 Report on Transactions
with Related Parties

IT-RELATED RISKS AND OPPORTUNITIES

The use of functional and high-performance IT systems is of central importance for an innovative and global Company such as NORMA Group with regard to the efficiency of its business processes. In this context, it is critical for the Company's success to support the business processes of NORMA Group, which are partly organized across corporate and national boundaries along the value chain with stable and powerful IT systems that provide the management at all levels with the necessary information in a timely manner and allow for efficient organization of workflows. For the exchange of information with customers and suppliers of NORMA Group, tailor-made IT solutions connected to the respective ERP systems are of great importance, too. With regard to this business-critical IT infrastructure, there is a risk that an extensive computer system failure, e.g. due to technical-related mal- functions of the systems or attacks by hackers, could seriously disrupt the Company's operations.

In addition, NORMA Group sees the risk that external users could gain unauthorized access to sensitive Company information and misuse it. In this context, unauthorized access to information about production processes, financial, customer and employee data could have a negative impact on the Company.

Therefore, NORMA Group has implemented appropriate measures to avoid and reduce this type of risk. These measures are collectively embedded in the IT risk management process and are adjusted in this context to changing conditions. For example, NORMA Group manages the IT risks it identifies by arranging for redundant provision of business-critical applications and databases via physically separated data center areas, using decentralized data storage and outsourced data archiving to a certified external provider, and by using up-to-date firewalls and e-mail filters, including permanent network monitoring. The access of employees to sensitive information is ensured by means of authorization systems customized for the respective positions, taking into account the principle of segregation of duties. Finally, employees are trained to be more aware of data security aspects.

NORMA Group estimates the probability of IT-related risks occurring in all regions despite the implemented countermeasures to be possible and the potential financial impact to be minor.

Opportunities in the area of IT arise in particular from the potential of process standardization and optimization across all companies of NORMA Group. For instance, the gradual migration from the old ERP systems to uniform new systems for the entire Group was further advanced in 2018. The opportunities that arise from this streamlining measure are considered to be likely. The related financial effects are expected to be minor.

LEGAL RISKS AND OPPORTUNITIES

Risks related to standards and contracts

Future changes to legislation and requirements, especially commercial law, liability law, environmental law, tax law, customs law and labor law, as well as changes in related standards, could have a negative impact on NORMA Group's development. Violations of laws and regulations, but also of contractual agreements, can lead to penalties, regulatory requirements or claims from injured parties. Conversely, NORMA Group can be adversely affected by legal or contractual breaches by third parties. In addition, defective products may result in legal disputes and liability for damages. Likewise, the results of tax audits can lead to tax payments, including penalties and interest.

In 2018, litigations against NORMA Group (passive), mainly involved labor disputes such as dismissal protection suits and product defects claimed by customers or their insurance companies. In Malaysia, the local subsidiary of NORMA Group won a lawsuit in connection with a plant that the opposing party insisted on buying and a claim for repayment of a deposit on the purchase price after the purchase was not carried out. Active proceedings mainly pertained to claims against suppliers. In addition, NORMA Group identified possible violations of its own IP rights or IP rights of third parties. Most of the proceedings were conducted in Germany and the US.

NORMA Group uses its current compliance and risk management systems to ensure that it complies with constantly changing laws and regulations and meets its contractual obligations. NORMA Group counters the risk of product defects through its Group-wide quality assurance program. In addition, NORMA Group is also insured against claims arising from certain defective products.

Due to the current significant changes in international tax law (e.g. the OECD BEPS Initiative), in particular, that can lead to unanswered legal questions, as well as due to the increased auditing intensity of tax audits that can be seen in many countries, the likelihood of risks related to standards and contracts is considered possible. However, due to the existing risk management measures, the potential financial impact of risks in connection with standards and contracts is still considered to be moderate.

Known legal risks to which NORMA Group is exposed and whose occurrence is sufficiently specified are adequately taken into account by provisions in the Consolidated Financial Statements.

37	Principles of the Group
51	Economic Report
74	Forecast Report
79	Risk and Opportunity Report
91	Remuneration Report
98	Other Legally Required Disclosures
101	Report on Transactions with Related Parties

Social and environmental standards

Violating social and environmental standards could damage the reputation of NORMA Group and result in restrictions, claims for damages or disposal obligations. NORMA Group has therefore implemented Corporate Responsibility as an integral part of the Group strategy. In this context, a systematic Environmental Management System was introduced at NORMA Group so that corporate decisions can always be evaluated also considering the goal of avoiding emissions and conserving resources. The Company also invests in the area of occupational health and safety for its continuous improvement. ► **EMPLOYEES, P. 69**

In 2018, a lawsuit was still filed in China due to the violation of local environmental standards because Fengfan Fastener released contaminated wastewater into the sewer system while manufacturing cable ties. As a result, the authorities imposed a penalty of CNY 805,000. Meanwhile, the wastewater contamination in question has been eliminated by installing new filter systems and using environmentally friendly cleaning agents. Consequently, the probabilities of occurrence of negative developments as a result of social and environmental risks are now assumed to be possible, however the potential financial impact is still considered to be moderate.

However, the investments in the area of Corporate Responsibility serve not only to ward off risks. The measures and initiatives are also seen as having the potential to positively impact both the business environment as well as NORMA Group and its stakeholders. Therefore, NORMA Group estimates the opportunities in this area to be possible and assumes that the measures and initiatives will have a minor impact on its planning.

Intellectual property

NORMA Group's position as a technology and innovation leader means that violations of its intellectual property rights could lead to lost sales and reputation. For this reason, the Company ensures that its technologies and innovations are legally protected. NORMA Group also minimizes the potential impact by developing customer-specific solutions and through its speed of innovation. At the same time, it is also possible for NORMA Group to violate the intellectual property of third parties. For this reason, developments for potential patent violations are reviewed at an early stage. Therefore, it is considered possible for the intellectual property to be violated. Due to the measures that NORMA Group has implemented, the potential impact of an intellectual property violation is regarded to be minor. In addition, NORMA Group also sees opportunities as possible that can lead to a minor deviation from the medium term plan as a result of the consistent defense of the intellectual property and the expansion of legal unique selling points.

**ASSESSMENT OF THE OVERALL PROFILE OF RISKS AND
OPPORTUNITIES BY THE MANAGEMENT BOARD**

The Group's overall situation results from the aggregation of individual risks and opportunities from all categories of the business units and functions. After assessing the likelihood of risks occurring and their potential financial impact as well as in light of the current business outlook, NORMA Group's Management Board does not believe that there is any individual risk or group of risks with the potential to jeopardize the continued existence of the Group or individual Group companies as a going concern. Taking the aggregated opportunities into account, NORMA Group is in a very good position with respect to both the medium and long terms to further expand its market position and grow globally. This assessment is reinforced by the good opportunities to cover the financing requirements. Therefore, NORMA Group has not made any effort to obtain an official rating from a leading rating agency.

General economic risks remain for NORMA Group in all areas, which is why setbacks on the way towards long-term realization of the growth and profitability targets cannot be ruled out. In contrast, there are clear opportunities that NORMA Group is taking advantage of through its strategy and consistent opportunity management, so that it is possible to even exceed its profitability targets.

The changes in the individual opportunities and risks shown in the overview have no significant impact on NORMA Group's overall risk profile. NORMA Group has therefore concluded that the Group's overall profile has not changed significantly compared to the previous year.

T030 RISK AND OPPORTUNITY PORTFOLIO OF NORMA GROUP¹

		Probability of occurrence					Financial impact						
		very unlikely	unlikely	possible	likely	very likely	change comp. to 2017	insignificant	minor	moderate	significant	high	change comp. to 2017
Financial risk and opportunities													
Default risk			■				▶	■					▶
Liquidity	Risks	■					▶					■	▶
	Opportunities				■		▶		■				▶
Currency	Risks			■			▶			■			▶
	Opportunities			■			▶			■			▶
Change in interest rates	Risks			■			▶		■				▶
	Opportunities		■				▶	■					▶
Economic and cyclical risks and opportunities													
	Risks			■			▶			■			▶
	Opportunities		■				▼		■				▶
Industry-specific and technological risks and opportunities													
	Risks			■			▶			■			▶
	Opportunities			■			▶			■			▶
Risks and opportunities associated with corporate strategy													
	Risks		■				▶			■			▶
	Opportunities			■			▶			■			▶
Operational risks and opportunities													
Commodity pricing	Risks				■		▶		■				▶
	Opportunities		■				▶		■				▶
Suppliers	Risks			■			▶		■				▶
	Opportunities			■			▶		■				▶
Quality and processes	Risks			■			▶		■				▶
	Opportunities			■			▶		■				▶
Customers	Risks			■			▶		■				▶
	Opportunities			■			▶		■				▶
Risks and opportunities of personnel management													
	Risks			■			▶	■					▶
	Opportunities				■		▶		■				▶
IT-related risks and opportunities													
	Risks			■			▶		■				▶
	Opportunities				■		▶		■				▶
Legal risks and opportunities													
Risks related to standards and contracts	Risks			■			▶			■			▶
Social and environmental standards	Risks			■			▶			■			▶
	Opportunities			■			▶		■				▶
Property rights	Risks			■			▶		■				▶
	Opportunities			■			▶		■				▶

¹_If not indicated differently, the risk assessment applies for all regional segments.



37	Principles of the Group
51	Economic Report
74	Forecast Report
79	Risk and Opportunity Report
91	Remuneration Report
98	Other Legally Required Disclosures
101	Report on Transactions with Related Parties

REMUNERATION REPORT

REMUNERATION OF THE MANAGEMENT BOARD

BASIC PRINCIPLES OF THE REMUNERATION SYSTEMS

The purpose of NORMA Group's remuneration system is to provide the members of the Management Board with adequate remuneration for their activities and areas of responsibility as well as their personal performance in accordance with applicable legislation and to provide them with a long-term incentive to commit themselves to the success of the Company. In addition to the criteria of the Company's performance and future prospects, the decision as to what level of remuneration is appropriate is also based on the general levels of remuneration paid by comparable companies and NORMA Group's remuneration structure.

In accordance with the recommendations of the German Corporate Governance Code in the version dated February 7, 2017, the remuneration comprises a fixed element and variable elements.

The basic remuneration is a fixed cash payment for the entire year based on the respective Management Board member's area of responsibility. This basic remuneration is paid in the form of a monthly salary.

The variable remuneration varies depending on the date on which the members of the Management Board take up their duties or sign their contracts. For members of the Board of Management who joined before 2015 – this applies to Mr. Deggim, Mr. Stephenson and Mr. Kleinhens (for the latter only the remuneration until 2017) – the variable remuneration generally consists of the following components:

1. The annual bonus is a variable cash payment calculated on the basis of the quantifiable performance of the Company in the previous fiscal year. The parameters taken into consideration are whether or not the Company reaches its target for an earnings component (adjusted EBITA) and a liquidity component (operating free cash flow before external use). Each of the two indicators is calculated for a fiscal year based on figures taken from the Company's Consolidated Financial Statements and compared to the target set in advance by the Supervisory Board. The annual salary of the Management Board member is multiplied by a percentage between 0% and 200%, depending on the extent to which the targets for the components were met. The range limits the annual bonus to 50% of the member's annual salary. In case of negative performance, it can be reduced to EUR 0.

2. The Company's Long-Term Incentive (LTI) Plan is a component of a variable remuneration element designed to support the Company's long-term performance. The LTI plan also comprises an EBITA component and an operating free cash flow before external use (FCF) component, each of which are observed over a period of three years (performance period). A new three-year performance period begins for every year. Both components are calculated by multiplying the average annual (adjusted) EBITA and FCF values actually achieved in the performance period by the (adjusted) EBITA and FCF bonus percentages specified in the employment contract. In a second step, the actual value of a component is compared to the medium-term plan approved by the Supervisory Board to evaluate the Company's performance and adjustments are made to the LTI plan. The LTI plan is limited to two and a half times the amount that would be arrived at on the basis of the figures in the Company's medium-term plan. If the actual value is lower than the planned value, the LTI plan is reduced on a straight-line basis down to a minimum of EUR 0 if the three-year targets are missed by a significant amount.
3. The Matching Stock Program (MSP) provides a share price-based long-term incentive to commit to the success of the Company. The MSP is a share-based option right.

To this end, the Supervisory Board specifies a number of stock options to be allotted each fiscal year with the proviso that the Management Board member makes a corresponding personal investment in the Company.

The MSP is split into different tranches. The first tranche was allotted on the day of the initial public offering (April 8, 2011). The other tranches were allotted on March 31 each following year, the last allotment took place on March 31, 2017 (no allotment in fiscal year 2018). The stock options relate to those shares allotted or acquired and qualified under the MSP as specified in the Management Board contract. The number of stock options is calculated by multiplying the qualified shares (for 2015, 2016 and 2017 85,952 shares per year) held at the allotment date by the option factor specified by the Supervisory Board. The option factor is re-determined for each tranche and amounts to 1.5 for each of the tranches in 2015, 2016 and 2017. In the fiscal years 2015, 2016 and 2017, 128,928 shares are to be considered. Every tranche will be recalculated taking changes in the influencing factors into consideration and balanced pro rata temporis over the vesting period.

37	Principles of the Group
51	Economic Report
74	Forecast Report
79	Risk and Opportunity Report
91	Remuneration Report
98	Other Legally Required Disclosures
101	Report on Transactions with Related Parties

The vesting period is four years and ends on March 31 2019, 2020 and 2021 respectively for the 2014, 2015, 2016 and 2017 tranches. The options in a tranche can only be exercised within a period of two years after the vesting period expires. As a precondition for exercising the options, the share price must exceed the exercise threshold when the options are exercised (basis: weighted average of the last ten exchange trading days before exercising the option). The exercise threshold is set by the Supervisory Board when the respective tranche is allocated and equals at least 120% of the exercise price. The exercise threshold was set at 120% of the strike price for the 2015, 2016 and 2017 tranches. In determining the exercise price of the tranches, the weighted average of the closing prices of the Company's share on the last 60 trading days that immediately preceded allocation of each tranche is to be applied. Dividend payments by the Company during the vesting period are to be deducted from the exercise price of each tranche.

The value of the stock options is calculated by an external assessor based on generally accepted business valuation models.

The Company is generally free to decide at the time of exercise whether compensation for the option is to be offered in the form of shares or a cash settlement. Due to the history of NORMA Group, a settlement in the form of a cash payment is expected for the future. For further information, please refer to the Notes. ► **NOTES, P. 174**

T 031 OVERVIEW OF THE MATCHING STOCK PROGRAM (MSP) AT THE TIME OF ALLOTMENT

Tranches	Option factor	Number of options	Exercise price in EUR	End of vesting period
2017	1.5	128,928	41.60	2021
2016	1.5	128,928	46.62	2020
2015	1.5	128,928	44.09	2019

On commencement of service from 2015 or in the case of new service contracts for the Management Board from 2015 on, this applies to Mr. Kleinhens (remuneration from 2018 on), Dr. Schneider and Dr. Klein, the variable remuneration of the Management Board consists of the following components:

1. The annual bonus is a variable compensation component, which refers to the average adjusted Group EBITA (earnings before interest, taxes and amortization) of the last three fiscal years. The Management Board receives a percentage of the amount of the three-year average. The annual bonus is limited to a maximum of two and a half times or two times the fixed annual

salary. The annual bonus for the previous fiscal year is to be paid after approval of the Consolidated Financial Statements by the Supervisory Board the following year. If the Management Board member has not worked for the Company for a full twelve months in a fiscal year, the annual bonus is reduced accordingly.

The following table gives an overview of the annual bonus:

T 032 ANNUAL BONUS

	Assessment basis	% rate	Cap
Bernd Kleinhens	Adj. EBITA of last three years (arithmetic mean)	0.60	Two and a half times the fixed salary
Dr. Michael Schneider	Adj. EBITA of last three years (arithmetic mean)	0.35	Two and a half times the fixed salary
Dr. Friedrich Klein	Adj. EBITA of last three years (arithmetic mean)	0.25	Two times the fixed salary

2. The Long-Term Incentive Plan is designed as a so-called NORMA Value Added Bonus and represents a part of the variable remuneration of the Management Board aligned toward sustained positive business development. This LTI provides a long-term incentive for the Management Board to work hard to make the Company successful. The LTI is an appreciation bonus that is based on the Group's performance. The Board member receives a percentage of the calculated increase in value. The NORMA Value Added Bonus corresponds to the percentage of the average increase in value from the current and the two previous fiscal years. The annual increase in value is calculated using the following formula:

$$\text{NORMA Value Added} = (\text{adjusted EBIT} \times (1 - t)) - (\text{WACC} \times \text{capital employed})$$

The calculation of the first component is based on the consolidated earnings before interest and taxes (Group EBIT) for the fiscal year and the average corporate tax rate. The second component is calculated from the Group WACC multiplied by the capital invested. The NORMA Value Added Bonus is limited to a maximum of one and a half times or one time the fixed annual salary. 75% or 90% of the amount attributable to the LTI is to be paid to the respective member of the Management Board the following year. The Company then uses the remaining 25%, resp. 10% attributable to the LTI to

37 Principles of the Group
 51 Economic Report
 74 Forecast Report
 79 Risk and
 Opportunity Report
91 Remuneration Report
 98 Other Legally
 Required Disclosures
 101 Report on Transactions
 with Related Parties

purchase shares of NORMA Group SE in the name and on behalf of the individual Board members. Alternatively, the Company may pay out this balance to the Board member. In this case, the Management Board member obligates himself to purchase shares of NORMA Group SE with the balance of this amount within 120 days after the Annual Financial Statements are approved at the Supervisory Board meeting. The Management Board member may not dispose of the shares for four years. Dividends and subscription rights are to be made freely available to the Management Board member. If a Board member takes office in the current fiscal year or does not work for the Company for a full twelve months in a fiscal year, the LTI is to be reduced proportionally (pro rata). Upon termination of the employment contract, a Management Board member may dispose of his shares only after 12 months of leaving the Company. Upon termination of his appointment to a body at the request of the Management Board or for another important reason, no future rights to variable components of the LTI shall be granted.

The following table provides an overview of the NORMA Value Added Bonus:

T 033 NORMA VALUE ADDED BONUS/LTI

	Assessment basis	% rate	Cap	Payment/ acquisition of shares
Bernd Kleinhens	NOVA of the last three years (arithm. mean)	1.00	One and a half times the fixed annual salary	90%/10%
Dr. Michael Schneider	NOVA of the last three years (arithm. mean)	1.00	One and a half times the fixed annual salary	75%/25%
Dr. Friedrich Klein	NOVA of the last three years (arithm. mean)	0.50	One annual salary	75%/25%

In addition, there is an entitlement to a pension upon commencement of service or signing of the contract as of 2015, which is measured as a percentage of the pensionable income. The pension entitlement arises when the contract has expired, but not before reaching the age of 65, or if that individual is unable to work. The percentage depends on the number of years of service as a Management Board member. The percentage amounts to 4% of the last yearly fixed salary prior to leaving for each completed year of service. The percentage can increase to a maximum of 55%. Furthermore, a survivor's pension is to be provided as well.

In the event of premature termination of the employment contract without an important reason, any payments to the Management Board are not to exceed the value of two annual remunerations and correspond at most to the value of the remuneration for the remaining term of the employment contract (see Section 4.2.3 of the GCGC). If a special right of termination is exercised in the event of a change of control, the Management Board receives compensation of three years' remuneration, but no more than the value of the remuneration for the remaining term of the employment contract (see Section 4.2.3 of the GCGC). The annual remuneration includes the current annual fixed salary as well as short- and long-term variable remuneration components from the past fiscal year.

The members of the Management Board are additionally compensated with a company car, which they can also use for personal purposes. Furthermore, Management Board members are reimbursed for any expenses and travel costs incurred while performing their duties for the Company in accordance with the Company's respectively applicable guidelines. Inventor's bonuses are also granted. The members of the Management Board arrange private insurance or are personally responsible for the statutory deductible of 10% of the loss for the D&O insurance policy carried for the Managing Directors of NORMA Group.

REMUNERATION OF THE MANAGEMENT BOARD IN FISCAL YEAR 2018

The Management Board's remuneration for fiscal year 2018 is reported in accordance with the applicable accounting principles (DRS 17) and the recommendations of the German Corporate Governance Code.

T 034 MANAGEMENT BOARD REMUNERATION IN 2018

IN EUR THOUSANDS	Bernd Kleinhens		Dr. Michael Schneider		Dr. Friedrich Klein (since Oct 1, 2018)		Werner Deggim (until Dec 31, 2017)		John Stephenson (until Jan 31, 2018)		Total	
	2018	2017	2018	2017	2018	2017	2018	2017	2018	2017	2018	2017
Fixed components	524	320	387	341	83	0	234	471	24	294	1,252	1,426
Performance-related components	1,011	90	590	0	106	0	0	135	0	84	1,707	309
Long-term incentive effect	591	1,256	591	861	74	0	64	1,462	8	629	1,330	4,208
Total remuneration	2,126	1,666	1,568	1,202	263	0	298	2,068	32	1,007	4,289	5,943

Management Board remuneration in 2018 according to the accounting standard DRS 17

The total remuneration of the Management Board pursuant to Section 315e in connection with Section 315a (2) and Section 314 (1) no. 6a sentence 5 of the German Commercial Code (HGB) is distributed among the individual members of the Management Board as shown in ► **TABLE 034**.

The performance-related components include only the short-term annual bonuses. The MSP and all other bonuses are listed under long-term incentives.

A provision was recognized for the variable compensation elements. The stock options associated with the MSP are assessed on an ongoing basis and included in other provisions in the income statement.

The benefits promised to the members of the Management Board in the event of the regular termination of their employment (cf. Section 315e in connection with Section 315a (2) and Section 314 (1) no. 6a sentence 6 HGB) are distributed among the individual members of the Management Board as shown in ► **TABLE 035**.

T 035 OVERVIEW OF THE PROMISED PENSIONS OF THE BOARD MEMBERS

IN EUR THOUSANDS	Bernd Kleinhens		Dr. Michael Schneider		Dr. Friedrich Klein (since Oct 1, 2018)		Total	
	2018	2017	2018	2017	2018	2017	2018	2017
Present value of pension	371	0	1,005	479	53	0	1,429	479
Expended/accrued amount	371	0	526	248	53	0	950	248

**Remuneration of the Management Board in 2018 in accordance
with the German Corporate Governance Code**

In accordance with the German Corporate Governance Code in its version dated February 7, 2017, which draws a distinction between remuneration that is being

granted for the year under review and inflow in or for the year under review, the remuneration of the Management Board is shown as follows (models recommended in the Code are being used):

T 036 REMUNERATION GRANTED TO THE MANAGEMENT BOARD

IN EUR THOUSANDS	Bernd Kleinhens				Dr. Michael Schneider				Dr. Friedrich Klein (since Oct 1, 2018)			
	2018	2018 (Min)	2018 (Max)	2017	2018	2018 (Min)	2018 (Max)	2017	2018	2018 (Min)	2018 (Max)	2017
Fixed remuneration	504	504	504	300	360	360	360	314	81	81	81	0
Benefits	20	20	20	20	27	27	27	27	2	2	2	0
Total	524	524	524	320	387	387	387	341	83	83	83	0
One-year variable remuneration	1,011	0	1,260	75	590	0	990	547	106	0	162	0
Multi-year variable remuneration												
LTI tranche 2017 – 2019	0	0	0	267	0	0	0	0	0	0	0	0
MSP 2017 – 2021	0	0	0	464	0	0	0	0	0	0	0	0
Other perennial remuneration	591	0	756	0	591	0	594	314	74	0	81	0
Sum	1,602	0	2,016	806	1,181	0	1,584	861	180	0	243	0
Pension expenses	473	473	473	0	225	225	225	197	65	65	65	0
Total remuneration	2,599	997	3,013	1,126	1,793	612	2,196	1,399	328	148	391	0

IN EUR THOUSANDS	Werner Deggim (until Dec 31, 2017)				John Stephenson (until Jan 31, 2018)				Total			
	2018	2018 (Min)	2018 (Max)	2017	2018	2018 (Min)	2018 (Max)	2017	2018	2018 (Min)	2018 (Max)	2017
Fixed remuneration	230	230	230	450	23	23	23	280	1,198	1,198	1,198	1,334
Benefits	4	4	4	21	1	1	1	14	54	54	54	82
Total	234	234	234	471	24	24	24	294	1,252	1,252	1,252	1,426
One-year variable remuneration	0	0	0	113	0	0	0	70	1,707	0	2,250	805
Multi-year variable remuneration												
LTI tranche 2017 – 2019	0	0	0	0	0	0	0	0	0	0	0	267
MSP 2017 – 2021	0	0	0	242	0	0	0	0	0	0	0	706
Other perennial remuneration	0	0	0	0	0	0	0	0	1,256	0	1,350	314
Sum	0	0	0	355	0	0	0	70	2,963	0	3,600	2,092
Pension expenses	0	0	0	0	0	0	0	0	763	763	763	197
Total remuneration	234	234	234	826	24	24	24	364	4,978	2,015	5,615	3,715

INTRODUCTION

OUR VISION

TO OUR SHAREHOLDERS

**CONSOLIDATED
MANAGEMENT REPORT**

CONSOLIDATED
FINANCIAL STATEMENTS

FURTHER INFORMATION

37 Principles of the Group

51 Economic Report

74 Forecast Report

79 Risk and
Opportunity Report

91 Remuneration Report

98 Other Legally
Required Disclosures

101 Report on Transactions
with Related Parties

T 037 INFLOW FROM MANAGEMENT BOARD MEMBER REMUNERATION

IN EUR THOUSANDS	Bernd Kleinhens		Dr. Michael Schneider		Dr. Friedrich Klein (since Oct 1, 2018)		Werner Deggim (until Dec 31, 2017)		John Stephenson (until Jan 31, 2018)		Total	
	2018	2017	2018	2017	2018	2017	2018	2017	2018	2017	2018	2017
Fixed remuneration	504	300	360	314	81	0	230	450	23	280	1,198	1,344
Benefits	20	20	27	27	2	0	4	21	1	14	54	82
Total	524	320	387	341	83	0	234	471	24	294	1,252	1,426
One-year variable remuneration	1,011	90	590	547	106	0	0	135	0	84	1,707	856
Multi-year variable remuneration												
LTI tranche 2015 – 2017	230	0	0	0	0	0	348	0	217	0	795	0
LTI tranche 2014 – 2016	0	186	0	0	0	0	0	281	0	175	0	642
MSP 2014 – 2018	718	0	0	0	0	0	1,080	0	670	0	2,468	0
MSP 2013 – 2017	0	741	0	0	0	0	0	1,116	0	692	0	2,549
Other perennial remuneration	591	0	591	300	74	0	0	0	0	0	1,256	300
Sum	2,550	1,017	1,181	847	180	0	1,428	1,532	887	951	6,226	4,347
Pension expenses	473	0	225	197	65	0	0	0	0	0	763	197
Total remuneration	3,547	1,337	1,793	1,385	328	0	1,662	2,003	911	1,245	8,241	5,970



37 Principles of the Group

51 Economic Report

74 Forecast Report

79 Risk and
Opportunity Report**91 Remuneration Report**98 Other Legally
Required Disclosures101 Report on Transactions
with Related Parties**REMUNERATION OF THE SUPERVISORY BOARD**

The remuneration for the Chairman and the Vice Chairman of the Supervisory Board was calculated separately in accordance with the recommendations of the German Corporate Governance Code in the version dated February 7, 2017. The Chairman is paid double the remuneration of the other members of the Supervisory Board, and the Vice Chairman is paid one and a half times this amount. In addition, the Chairman and members of the Supervisory Board's committees are remunerated separately.

The Supervisory Board members will be remunerated for their activities on the day after the 2019 Annual General Meeting as follows:

T 038 REMUNERATION OF THE SUPERVISORY BOARD 2018

Supervisory Board member	Membership/Chairman of a committee	Remuneration in EUR
Lars M. Berg	Chairman of the Supervisory Board (since May 17, 2018)	
	Chairman of the General and Nomination Committee (since May 17, 2018)	
	Vice Chairman of the Supervisory Board (until May 17, 2018)	
	Member of the Audit Committee (until May 17, 2018)	
	Member of the General and Nomination Committee (until May 17, 2018)	104,410.96
Erika Schulte	Vice Chairwoman of the Supervisory Board (since May 17, 2018)	
	Member of the Audit Committee	75,684.93
Rita Forst (since May 17, 2018)	Member of the Audit Committee	37,643.84
Günter Hauptmann	Member of the General and Nomination Committee (since May 17, 2018)	56,273.97
Dr. Knut J. Michelberger	Chairman of the Audit Committee	
	Member of the General and Nomination Committee (since May 17, 2018)	91,273.97
Mark Wilhelms (since August 29, 2018)	Not a member of a Committee	17,123.29
Dr. Christoph Schug (until May 17, 2018)	Member of the General and Nomination Committee	22,520.55
Dr. Stefan Wolf (until May 17, 2018)	Chairman of the Supervisory Board	
	Member of the General and Nomination Committee	41,287.67
Total		446,219.18

No remuneration was paid to Supervisory Board members in fiscal year 2018 for services personally rendered (in particular advisory and brokerage services).

Furthermore, the Supervisory Board members are reimbursed for any expenses and travel costs incurred while performing their duties for the Company in accordance with the Company's respectively applicable guidelines. The members of the Supervisory Board arrange private insurance or are personally responsible for the statutory deductible of 10% of the loss for the D&O insurance policy carried for the Management Board and the Supervisory Board of NORMA Group.

37	Principles of the Group
51	Economic Report
74	Forecast Report
79	Risk and Opportunity Report
91	Remuneration Report
98	Other Legally Required Disclosures
101	Report on Transactions with Related Parties

OTHER LEGALLY REQUIRED DISCLOSURES

An overview of the information required under Section 315a paragraph 1 of the German Commercial Code (Handelsgesetzbuch, HGB) is presented below:

SECTION 315A (1) NO. 1 HGB

NORMA Group SE's share capital totalled EUR 31,862,400.00 on December 31, 2018. This is divided into 31,862,400 registered shares with no par value. Each share entitles the bearer to one vote. There are no other classes of shares. NORMA Group SE holds no treasury shares.

SECTION 315A (1) NO. 2 HGB

The Management Board of NORMA Group SE is not aware of any restrictions affecting voting rights or the transfer of shares or any agreements between shareholders which could result in such restrictions.

SECTION 315A (1) NO. 3 HGB

There are no direct or indirect capital holdings exceeding one tenth of the voting rights other than those voting rights listed in the Notes to the Consolidated Financial Statements.

SECTION 315A (1) NO. 4 HGB

There are no shares in NORMA Group SE that confer special control rights to the holder.

SECTION 315A (1) NO. 5 HGB

There are no employee share schemes through which employees can acquire shares of NORMA Group SE. Employees with shareholdings in NORMA Group SE exercise control rights in the same way as other shareholders in accordance with applicable legislation and the Articles of Association.

SECTION 315A (1) NO. 6 HGB

Management Board members are appointed and dismissed in accordance with Section 84 et seq. of the German Stock Corporation Act (Aktiengesetz, AktG). The Articles of Association of NORMA Group SE do not contain any provisions related to this issue that contradict the applicable legislation. The Supervisory Board is responsible for determining the concrete number of members on the Management Board. It can nominate a Chairman and Vice Chairman of the Management Board or a Management Board spokesperson and a deputy spokesperson.

Changes to the Articles of Association are to be decided on by the Annual General Meeting in accordance with Section 179 (1) AktG. In accordance with Section 179 (1) sentence 2 AktG, the Annual General Meeting can authorize the

Supervisory Board to make changes which affect only the wording of the Articles of Association. The Annual General Meeting of NORMA Group SE has chosen to do so: According to Article 14 (2) of the Articles of Association, the Supervisory Board is authorized to make changes to the Articles of Association which only affect their wording. In accordance with article 20 sentence 3 of the Articles of Association, a simple majority of votes submitted is sufficient for a resolution on changing the Articles of Association if at least half of the share capital is represented when the resolution is adopted and a different majority is not required under the law.

The Supervisory Board is authorized to amend the wording of article 6 of the Articles of Association to reflect the issue of the new shares from the Conditional Capital 2015. The same will apply insofar as the authorization to issue convertible bonds, bonds with warrants, and / or participation rights with or without conversion or option rights or conversion or option obligations in accordance with the Annual General Meeting's resolution of May 20, 2015, is not exercised during the term of the authorization or the corresponding option or conversion rights or option or conversion obligations have lapsed because the exercise periods have expired or for another reason.

The Supervisory Board is authorized to amend the wording of article 5 of the Articles of Association in accordance with the issuance of new shares from the Authorized Capital 2015 and, provided that the Authorized Capital 2015 has not been utilized or not been fully utilized by May 19, 2020, adjust the authorization after that deadline has expired.

The Management Board may determine that the share capital is to remain unchanged in the event that shares are to be withdrawn and, instead, be increased by withdrawing a percentage of the remaining shares in the share capital pursuant to Section 8 (3) German Stock Corporation Act. In this case, the Management Board is authorized to adjust the number of shares in the Articles of Association.

SECTION 315A (1) NO. 7 HGB

Authorized Capital

In accordance with the resolution passed at the Annual General Meeting on May 20, 2015, the Management Board is authorized, with the Supervisory Board's consent, to increase the Company's share capital once or repeatedly by up to a total of EUR 12,744,960 on or before May 19, 2020, by issuing up to 12,744,960 new registered shares against cash and / or non-cash contributions (Authorized Capital 2015).

37 Principles of the Group

51 Economic Report

74 Forecast Report

79 Risk and
Opportunity Report

91 Remuneration Report

**98 Other Legally
Required Disclosures**101 Report on Transactions
with Related Parties

The Management Board is authorized, with the Supervisory Board's consent, to exclude the shareholders' subscription rights wholly or in part, once or repeatedly, in accordance with the following provisions:

- ▶ to exclude the shareholders' subscription rights for fractional amounts;
- ▶ if and to the extent that it is necessary to grant the bearers or creditors of conversion or option rights and/or the bearers or creditors of financing instruments carrying conversion or option obligations which were or are issued by NORMA Group SE, or by a domestic or foreign Company in which NORMA Group SE holds directly or indirectly the majority of the votes and capital;
- ▶ in the case of a capital increase against cash contributions pursuant to and according to Section 186 (3), sentence 4 German Stock Corporation Act, if the par value of the new shares is not substantially lower than the stock exchange price of the already listed shares in the Company and if the new shares which were issued under exclusion of the subscription right do not exceed a proportional amount of 10% of the share capital in total;
- ▶ in case of capital increases against non-cash contributions, in particular for the purpose of acquiring enterprises, parts of enterprises or interests in enterprises.

The Authorized Capital 2011/II which was resolved by the Annual General Meeting on April 6, 2011, has thus been cancelled by resolution of the Annual General Meeting on May 20, 2015. Article 5 of the Articles of Association of NORMA Group SE has been changed accordingly.

Conditional Capital

The Management Board is authorized to issue, with the Supervisory Board's consent, once or repeatedly on or before May 19, 2020, bearer or registered convertible bonds and/or bonds with warrants and/or participation rights carrying a conversion or option right and/or conversion or option obligation (or a combination of these instruments) in a total nominal amount of up to EUR 200,000,000 with or without a limited maturity term (hereinafter referred to collectively as 'bonds') and to grant the creditors of bonds conversion/option rights and/or lay down for the creditors of bonds conversion/option obligations to subscribe to a total of up to 3,186,240 new registered shares of the Company with a pro rata amount of the share capital of a total of up to EUR 3,186,240 in accordance with the terms and conditions of the bonds.

The share capital of the Company is conditionally increased by up to EUR 3,186,240 through an issuance of up to 3,186,240 new registered shares (Conditional Capital 2015).

The purpose of the Conditional Capital is to issue shares to the creditors of convertible bonds and/or bonds with warrants and/or participation rights carrying an option/conversion right and/or a conversion/option obligation (or a combination of such instruments), which will be issued based on the authorizations granted by the Annual General Meeting of NORMA Group SE on May 20, 2015, or domestic or foreign companies in which NORMA Group SE directly or indirectly holds the majority of the votes and the capital.

New shares are issued at the conversion or option price to be determined in each case in accordance with the respective authorization. The conditional increase in capital will be performed only insofar as the bearers of conversion or option rights based on the aforementioned bonds or participation rights exercise their conversion or option rights or conversion or option obligations that are based on such bonds are fulfilled, and insofar as the conversion or option rights and/or conversion or option obligations are not satisfied through own shares, shares from authorized capital or other consideration.

The new shares will participate in the profit as of the beginning of the fiscal year in which they are issued; notwithstanding the above, the Management Board may, if permitted by law, resolve with the consent of the Supervisory Board that the new shares be able to participate in the profit as of the beginning of an earlier fiscal year for which, at the time of their issue, the Annual General Meeting has not yet resolved on the appropriation of the net retained profit.

The authorization of the Management Board to issue warrants and convertible bonds and participation rights with warrants and convertible rights and the Conditional Capital 2011 resolved by the Annual General Meeting on April 6, 2011, were cancelled by shareholder resolution on May 20, 2015. Article 6 of the Articles of Association of NORMA Group SE has been amended accordingly.

Authorization to acquire own shares

Pursuant to the resolution of the Annual General Meeting on May 20, 2015, NORMA Group SE is authorized to acquire up to a total of 10% of its own share capital at the time at which the resolution was adopted or – in the event that this value is lower – at the time that the authorization is exercised via the stock exchange or via a public purchase offer on or before May 19, 2020, for any permissible purpose. This authorization may be exercised by NORMA Group SE in whole or in partial amounts, once or repeatedly, in pursuit of one or more purposes, but also be carried out by companies that are dependent on NORMA Group SE or in which NORMA Group SE holds a majority of the shares, or on its or their account. If the shares are acquired on the stock exchange, the equivalent value per share that is paid (without ancillary acquisition costs) may not exceed the price of the share in NORMA Group SE in the Xetra trading system (or a com-



37 Principles of the Group

51 Economic Report

74 Forecast Report

79 Risk and
Opportunity Report

91 Remuneration Report

**98 Other Legally
Required Disclosures**101 Report on Transactions
with Related Parties

parable successor system), as determined on the trading day in Frankfurt/Main by the opening auction, by more than 10% and not fall below it by more than 20%. If the acquisition is effected by way of a public purchase offer, the purchase price offered or the threshold values of the purchase price margin (excluding ancillary acquisition costs) may not exceed the closing price of the NORMA Group SE share in the Xetra trading system (or a comparable successor system) on the third trading day in Frankfurt/Main prior to the day of the public announcement of the offer by more than 10% and not fall below it by more than 20%. Should the relevant price vary by a not inconsiderable extent following the publication of the public purchase offer, the offer may be adjusted. In this case, the closing price on the third trading day in Frankfurt/Main prior to the public announcement will be based on any adjustment that has been made.

The Management Board is authorized to use shares of the Company for any legal purpose, once or repeatedly, in whole or in part, and also through dependent or majority-owned NORMA Group SE related companies or through third parties acting on their behalf or on behalf of NORMA Group SE. In particular, the shares acquired may be redeemed without such redemption or its implementation requiring a shareholder resolution. The cancellation leads in principle to a capital reduction. The Management Board may alternatively determine that the share capital is to remain unchanged upon redemption. In addition, the Management Board is expressly authorized to use the shares acquired under this authorization on one or more occasions, in whole or in part, individually or jointly, and also by dependent or majority-owned NORMA Group SE related companies or, on their account or third parties acting on the account of NORMA Group SE as follows:

- ▶ for sale against cash, provided that the price is not significantly below the stock market price of shares of the Company at the time of sale (simplified exclusion of subscription rights in accordance with Sections 186 para. 3 sentence 4, 71 para. 1 no. 8 sentence 5 half-sentence 2, German Stock Corporation Act, is limited to a maximum of 10% of the share capital),
- ▶ for sale against payment in kind, particularly for the acquisition of companies, parts of companies or participations in companies,
- ▶ to meet obligations under conversion or option rights or obligations to act or option,
- ▶ to issue in connection with share-based payments and employee share participation programs. The purchase right of shareholders to these own shares is excluded in the event of an appropriate use.

NORMA Group SE is authorized to acquire its own shares within the framework of the aforementioned, related to the share capital limits, and by using derivatives such as put options, call options, forward purchases or a combination of

these instruments and to take out derivative transactions. The acquisition of shares by using derivatives is limited to a number of shares that does not exceed a proportionate amount of 5% of the existing share capital at the time.

SECTION 315A (1) NO. 8 HGB

NORMA Group's financing agreements including the contracts for the promissory notes include the typical Change of Control Clause. In the event of a takeover by a third party, the possibility that NORMA Group would not be able to finance itself at similarly favorable terms and conditions cannot be ruled out.

SECTION 315A (1) NO. 9 HGB

NORMA Group SE has no agreements in place that provide compensation for members of the Management Board or employees in the event of a takeover bid. Please see the Remuneration Report for further details. ▶ **REMUNERATION REPORT, P. 91**

INTRODUCTION

OUR VISION

TO OUR SHAREHOLDERS

**CONSOLIDATED
MANAGEMENT REPORT**

CONSOLIDATED
FINANCIAL STATEMENTS

FURTHER INFORMATION

REPORT ON TRANSACTIONS WITH RELATED PARTIES

In fiscal year 2018, there were no significant transactions with related companies or persons besides the minority activities of members of the Management Board described in the Corporate Governance Report.

37 Principles of the Group

51 Economic Report

74 Forecast Report

79 Risk and
Opportunity Report

91 Remuneration Report

98 Other Legally
Required Disclosures

**101 Report on Transactions
with Related Parties**



1 __ Safe and durable: Compression fittings allow polyethylene hoses to be connected quickly and reliably.



2 __ Versatile: e.g. for compressed air in industry, irrigation in agriculture or for use in the private sector.

3 __ Durable under all circumstances: The component is particularly UV-, temperature- and pressure-resistant.

PERFORMANCE

LIVING PERFORMANCE

Our customers' industry requirements are changing rapidly. We cannot afford to stagnate and have to think ahead. Exact knowledge of our customers' needs, innovative thinking and technological know-how are therefore among our core competencies.



**Production of
Quick Connectors**
for exhaust
aftertreatment

POTENTIAL BECOMES REALITY

We operate in an innovation-driven environment that places the highest demands on our products and processes. We gladly accept this challenge and bring our understanding of performance and the demands of our customers into balance. Our success is expressed in strong operational growth.

The growing legal requirements placed on the reduction of emissions from motor vehicles and water management rank among the important drivers of our growth. Our broad diversification with regard to products, regions and end markets, as well as our international presence, creates optimal conditions, not only to further expand our business activities: We are striving to develop the

application solutions to continuously expand our current customer base, identify and acquire new customers and develop new markets with attractive growth potential.

GROWTH AND ACQUISITIONS

In fiscal year 2018, we achieved organic growth of 7.7%. The most recent acquisitions then contributed another 1.6% to growth: With the integration of the Chinese joining company Fengfan Fastener (Shaoxing) Co., Ltd. in May 2017, we not only expanded our portfolio, but also our position in the Chinese market.

The Indian company Kimplas Piping Systems Ltd. develops and produces solutions for water management and has been part of NORMA Group since July 2018. This acquisition strengthens our expertise in the booming industry and our presence in Southeast Asia.

With Statek Stanzertechnik GmbH, we acquired a long-standing supplier in August 2018. By doing so, we strategically extended our value chain and at the same time strengthened our flexibility in important product areas.



Constance von Struensee
Executive Vice President
Human Resources

“PEOPLE MAKE SUCCESS.”

A QUESTION OF INNOVATIVENESS

Innovation is not only limited to our products. Internal processes are also regularly evaluated and improved. One of the most important projects at present is the implementation of a globally uniform software solution for resource planning. We are thus standardizing our business processes across all locations and can use machines, personnel, capital and supplied parts optimally. This project is a Company-wide feat of strength, but the effort is worth it: when processes are globally aligned and we all speak the same language, we can grow together even closer and gain strength.

BRIEF INTERVIEW WITH CONSTANCE VON STRUENSEE

Executive Vice President Human Resources

What makes up the company culture at NORMA Group?

At NORMA Group, we are united by inspiring, very collegial interaction. Across sites and beyond borders and continents, we learn from each other. This culture will continue to apply in the years to come, while NORMA Group will once again grow strongly. In addition, the will to perform our tasks with a pioneering spirit unites us. Through the appropriate freedom and short decision paths, every employee can make his individual contribution and drive things forward. ‘Adapt fast. Enjoy speed. Don’t hesitate – take action!’ are also our culture drivers.

What does NORMA Group do to promote and appreciate the commitment and personal performance of its employees?

We promote the development of our employees and empower our top performers at all sites in a targeted manner – through annual talent reviews, for example. These start at the plant level based on a regional selection process and are then discussed over a period of several days with the Group Management Board. Short-term foreign

assignments, so-called bubble assignments, at other locations of the Group are also quite popular. Our employees are open to new cultures, learn a lot professionally as well as personally and can use their valuable experience when they return home. Besides the various bonus systems, the incentive on the individual level also includes innovation management: employees who have ideas and suggestions for improvements can earn the status of an Innovation Scout. With internal awards, NORMA Group also honors employees who stand out with outstanding performances in the areas of innovation and sales each year.

What are the main performance indicators?

High and consistent customer satisfaction is how we measure the success of our employees. We ensure that every employee can make his or her contribution to the success of the Company by way of transparent target agreements.

INTRODUCTION

OUR VISION

TO OUR SHAREHOLDERS

CONSOLIDATED
MANAGEMENT REPORT

**CONSOLIDATED
FINANCIAL STATEMENTS**

FURTHER INFORMATION

CONSOLIDATED FINANCIAL STATEMENTS

- 106 Consolidated Statement of Comprehensive Income
- 107 Consolidated Statement of Financial Position
- 108 Consolidated Statement of Cash Flows
- 109 Consolidated Statement of Changes in Equity
- 110 Notes to the Consolidated Financial Statements
- 197 Appendix to the Notes to the Consolidated Financial Statements
- 200 Responsibility Statement
- 201 Independent Auditor's Report

CONSOLIDATED STATEMENT OF COMPREHENSIVE INCOME
CONSOLIDATED STATEMENT OF FINANCIAL POSITION
CONSOLIDATED STATEMENT OF CASH FLOWS
CONSOLIDATED STATEMENT OF CHANGES IN EQUITY
NOTES TO THE CONSOLIDATED FINANCIAL STATEMENTS
APPENDIX TO THE NOTES TO THE CONSOLIDATED FINANCIAL STATEMENTS
RESPONSIBILITY STATEMENT
INDEPENDENT AUDITOR'S REPORT

CONSOLIDATED STATEMENT OF COMPREHENSIVE INCOME

T 039 CONSOLIDATED STATEMENT OF COMPREHENSIVE INCOME

IN EUR THOUSANDS

	Note	2018	2017
Revenue	(8)	1,084,140	1,017,084
Changes in inventories of finished goods and work in progress		10,383	-1,072
Other own work capitalized		5,197	3,911
Raw materials and consumables used	(9)	-473,551	-419,748
Gross profit		626,169	600,175
Other operating income	(10)	15,589	19,475
Other operating expenses	(11)	-162,016	-153,159
Employee benefits expense	(12)	-282,768	-270,237
Depreciation and amortization	(18, 19)	-63,429	-58,467
Operating profit		133,545	137,787
Financial income		2,703	924
Financial costs		-14,371	-16,979
Financial costs – net	(13)	-11,668	-16,055
Profit before income tax		121,877	121,732
Income taxes	(16)	-30,089	-1,916
Profit for the period		91,788	119,816
Other comprehensive income for the period, net of tax			
Other comprehensive income that can be reclassified to profit or loss, net of tax		10,749	-35,423
Exchange differences on translation of foreign operations	(23)	10,068	-35,812
Cash flow hedges, net of tax	(20, 23)	748	389
Costs of hedging, net of tax	(20, 23)	-67	0
Other comprehensive income that cannot be reclassified to profit or loss, net of tax		-214	-321
Remeasurements of post-employment benefit obligations, net of tax	(23, 25)	-214	-321
Other comprehensive income for the period, net of tax		10,535	-35,744
Total comprehensive income for the period		102,323	84,072
Profit attributable to			
Shareholders of the parent		91,873	119,664
Non-controlling interests		-85	152
		91,788	119,816
Total comprehensive income attributable to			
Shareholders of the parent		102,540	83,902
Non-controlling interests		-217	170
		102,323	84,072
(Un)diluted earnings per share (in EUR)	(15)	2.88	3.76

106	Consolidated Statement of Comprehensive Income
107	Consolidated Statement of Financial Position
108	Consolidated Statement of Cash Flows
109	Consolidated Statement of Changes in Equity
110	Notes to the Consolidated Financial Statements
197	Appendix to the Notes to the Consolidated Financial Statements
200	Responsibility Statement
201	Independent Auditor's Report

CONSOLIDATED STATEMENT OF FINANCIAL POSITION

T 040 CONSOLIDATED STATEMENT OF FINANCIAL POSITION

ASSETS

IN EUR THOUSANDS	Note	Dec 31, 2018	Dec 31, 2017
Non-current assets			
Goodwill	(18)	389,505	356,717
Other intangible assets	(18)	283,394	255,729
Property, plant and equipment	(19)	243,326	205,153
Other non-financial assets	(22)	2,404	1,048
Derivative financial assets	(20)	2,180	1,885
Income tax assets		878	76
Deferred income tax assets	(17)	6,571	4,845
		928,258	825,453
Current assets			
Inventories	(21)	178,107	151,229
Other non-financial assets	(22)	17,984	15,754
Other financial assets	(20)	5,231	1,001
Derivative financial assets	(20)	584	640
Income tax assets		6,807	9,884
Trade and other receivables	(20)	143,138	152,746
Contract assets	(8)	1,185	0
Cash and cash equivalents	(28)	190,392	155,323
		543,428	486,577
Total assets		1,471,686	1,312,030

LIABILITIES

IN EUR THOUSANDS	Note	Dec 31, 2018	Dec 31, 2017
Equity attributable to equity holders of the parent			
Subscribed capital		31,862	31,862
Capital reserve		210,323	210,323
Other reserves		2,517	-8,364
Retained earnings		356,022	298,077
Equity attributable to shareholders		600,724	531,898
Non-controlling interests		1,717	2,423
Total equity	(23)	602,441	534,321
Liabilities			
Non-current liabilities			
Retirement benefit obligations	(25)	12,804	12,127
Provisions	(26)	7,260	10,239
Borrowings	(20)	455,759	455,111
Other non-financial liabilities	(27)	431	489
Contract liabilities	(8)	149	0
Other financial liabilities	(20)	1,992	4,224
Derivative financial liabilities	(20)	605	1,226
Deferred income tax liabilities	(17)	73,099	60,543
		552,099	543,959
Current liabilities			
Provisions	(26)	8,750	8,545
Borrowings	(20)	113,332	33,136
Other non-financial liabilities	(27)	26,984	31,860
Contract liabilities	(8)	453	0
Other financial liabilities	(20)	18,866	6,307
Derivative financial liabilities	(20)	153	193
Income tax liabilities		6,580	7,960
Trade and other payables	(20)	142,028	145,749
		317,146	233,750
Total liabilities		869,245	777,709
Total equity and liabilities		1,471,686	1,312,030

106 Consolidated
Statement of
Comprehensive
Income107 Consolidated
Statement of
Financial Position**108 Consolidated
Statement of
Cash Flows**109 Consolidated
Statement of
Changes in Equity110 Notes to the
Consolidated Financial
Statements197 Appendix to the Notes to
the Consolidated
Financial Statements200 Responsibility
Statement201 Independent
Auditor's Report

CONSOLIDATED STATEMENT OF CASH FLOWS

T041 CONSOLIDATED STATEMENT OF CASH FLOWS

IN EUR THOUSANDS

	Note	2018	2017
Operating activities			
Profit for the period		91,788	119,816
Depreciation and amortization	(18, 19)	63,429	58,467
Gain (-)/loss (+) on disposal of property, plant and equipment		184	113
Change in provisions	(25, 26)	777	3,744
Change in deferred taxes	(17)	-5,401	-32,400
Change in inventories, trade account receivables and other receivables, which are not attributable to investing or financing activities	(20, 21, 22)	-2,651	-47,336
Change in trade and other payables, which are not attributable to investing or financing activities	(20, 27)	-20,960	30,048
Change in reverse factoring liabilities		-6,198	2,010
Payments for share-based payments		-3,513	-3,981
Interest expenses in the period		13,218	13,609
Income (-)/expenses (+) due to measurement of derivatives		436	-4,552
Other non-cash expenses (+)/income (-)	(28)	-266	6,458
Cash flow from operating activities		130,843	145,996
thereof interest received		484	396
thereof income taxes		-33,072	-37,012
Investing activities			
Payments for acquisitions of subsidiaries, net	(28, 32)	-69,797	-23,746
Investments in property, plant and equipment and intangible assets	(18, 19)	-60,842	-47,870
Proceeds from the sale of property, plant and equipment		1,131	854
Cash flow from investing activities		-129,508	-70,762
Financing activities			
Proceeds from outstanding capital contributions to a newly acquired subsidiary by former owner		0	3,924
Payments for the acquisition of non-controlling interests		-1,121	0
Interest paid		-13,676	-13,672
Dividends paid to shareholders	(23)	-33,456	-30,269
Dividends paid to non-controlling interests		-134	-159
Proceeds from borrowings	(20)	117,467	498
Repayment of borrowings	(20)	-37,266	-42,753
Proceeds from/ repayment of derivatives		-409	4,941
Repayment of lease liabilities		-123	-201
Cash flow from financing activities	(28)	31,282	-77,691
Net change in cash and cash equivalents		32,617	-2,457
Cash and cash equivalents at the beginning of the year		155,323	165,596
Effect of foreign exchange rates on cash and cash equivalents		2,452	-7,816
Cash and cash equivalents at the end of the period		190,392	155,323

CONSOLIDATED STATEMENT OF CHANGES IN EQUITY

T 042 CONSOLIDATED STATEMENT OF CHANGES IN EQUITY

106 Consolidated Statement of Comprehensive Income

107 Consolidated Statement of Financial Position

108 Consolidated Statement of Cash Flows

109 Consolidated Statement of Changes in Equity

110 Notes to the Consolidated Financial Statements

197 Appendix to the Notes to the Consolidated Financial Statements

200 Responsibility Statement

201 Independent Auditor's Report

IN EUR THOUSANDS	Note	Attributable to equity holders of the parent				Total	Non-controlling interests	Total equity
		Subscribed capital	Capital reserve	Other reserves	Retained earnings			
Balance as of December 31, 2016		31,862	210,323	27,077	213,504	482,766	819	483,585
Changes in equity for the period								
Result for the period					119,664	119,664	152	119,816
Exchange differences on translation of foreign operations				-35,830		-35,830	18	-35,812
Cash flow hedges, net of tax	(20)			389		389		389
Remeasurements of post-employment benefit obligations, net of tax	(23, 25)				-321	-321		-321
Total comprehensive income for the period		0	0	-35,441	119,343	83,902	170	84,072
Dividends paid	(23)				-30,269	-30,269		-30,269
Dividends paid to non-controlling interests						0	-159	-159
Non-controlling interest acquired in a business combination	(23)				-4,501	-4,501	1,593	-2,908
Total transactions with owners for the period		0	0	0	-34,770	-34,770	1,434	-33,336
Balance as of Dec 31, 2017 (as reported)		31,862	210,323	-8,364	298,077	531,898	2,423	534,321
Effects of IFRS 9					-600	-600	-13	-613
Balance as of Jan 1, 2018		31,862	210,323	-8,364	297,477	531,298	2,410	533,708
Changes in equity for the period								
Result for the period					91,873	91,873	-85	91,788
Exchange differences on translation of foreign operations				10,200		10,200	-132	10,068
Cash flow hedges, net of tax	(20)			681		681		681
Remeasurements of post-employment benefit obligations, net of tax	(23, 25)				-214	-214		-214
Total comprehensive income for the period		0	0	10,881	91,659	102,540	-217	102,323
Dividends paid	(23)				-33,456	-33,456		-33,456
Dividends paid to non-controlling interests						0	-134	-134
Acquisition of non-controlling interests	(23)				342	342	-342	0
Total transactions with owners for the period		0	0	0	-33,114	-33,114	-476	-33,590
Balance as of December 31, 2018		31,862	210,323	2,517	356,022	600,724	1,717	602,441

NOTES TO THE CONSOLIDATED FINANCIAL STATEMENTS

GENERAL INFORMATION

1. GROUP INFORMATION

NORMA Group SE is the ultimate parent Company of NORMA Group. Its headquarters are located at 63477 Maintal, Edisonstrasse 4, in the vicinity of Frankfurt, Germany, and the Company is registered in the commercial register of Hanau under the number HRB 94473. NORMA Group SE and its affiliated Group subsidiaries operate in the market as 'NORMA Group.'

NORMA Group has been listed in the Prime Standard of Frankfurt Stock Exchange's Regulated Market since April 8, 2011. For a detailed overview of NORMA Group's shareholdings, please refer to the ► **APPENDIX TO THE NOTES: 'VOTING RIGHTS.'**

NORMA Group SE was established in 2006 as a result of the merger of Rasmussen GmbH and the ABA Group. Rasmussen was founded in 1949 as Rasmussen GmbH in Germany. It manufactured connecting and retaining elements as well as fluid conveying conduits such as monolayer and multilayer tubes and corrugated tubes. All products were marketed globally under the NORMA brand. ABA Group was founded in 1896 in Sweden. The Group has since developed into a leading multinational company specializing in the design and production of hose and pipe clamps, as well as connectors for many worldwide applications.

In past decades, NORMA Group has, driven by its successful acquisitions and continuous technological innovation with products and operations, developed into a Group of companies of global importance.

In fiscal year 2018, NORMA Group acquired Kimplas Piping Systems Ltd. and Kimplas Ltd. ('Kimplas'), based in Nashik, Maharashtra, India and Essex, Great Britain and STATEK Stanzertechnik GmbH ('Statek'), based in Maintal, Germany.

NORMA Group markets its products to its customers via two different market channels: Engineered Joining Technology (EJT) and Distribution Services (DS).

For Engineered Joining Technology (EJT) customers, NORMA Group offers tailor-made solutions and special engineered joining systems. To effectively fulfill

special requirements, NORMA Group builds on extensive industry and application knowledge, a successful track record of innovation and long-standing relationships with all its key customers. As a result, many joining systems and fluid conveying conduits have been developed in close cooperation with global OEMs and NORMA Group.

For Distribution Services (DS) customers, NORMA Group offers a wide range of standard fastening and fixing products. Furthermore, NORMA Group offers a broad technological and innovative product portfolio which includes brands like ABA®, Breeze®, Clamp-All®, CONNECTORS®, FISH®, Five Star®, Gemi®, NDS®, NORMA®, Raindrip®, R.G.RAY®, Serflex® and TORCA®.

2. BASIS OF PREPARATION

The principal accounting policies applied in the preparation of these Consolidated Financial Statements are set out below. These policies have been consistently applied to all the years presented, unless otherwise stated.

The Consolidated Financial Statements of NORMA Group have been prepared in accordance with International Financial Reporting Standards and the relevant interpretations as adopted by the EU (IFRS) as well as with the regulations under commercial law as set forth in section 315e of the German Commercial Code (HGB) for the year ended December 31, 2018.

The Consolidated Statement of Comprehensive Income has been prepared in accordance with the total cost method.

The Consolidated Financial Statements of NORMA Group SE were prepared by the Management Board on March 8, 2019, and are scheduled to be released for publication after they were approved by the Supervisory Board on March 18, 2019.

The Consolidated Financial Statements of NORMA Group are being filed with and published in the German Federal Gazette (Bundesanzeiger).

106	Consolidated Statement of Comprehensive Income
107	Consolidated Statement of Financial Position
108	Consolidated Statement of Cash Flows
109	Consolidated Statement of Changes in Equity
110	Notes to the Consolidated Financial Statements
197	Appendix to the Notes to the Consolidated Financial Statements
200	Responsibility Statement
201	Independent Auditor's Report

The preparation of financial statements in conformity with IFRS requires the use of certain accounting estimates. It also requires management to exercise its judgment in the process of applying the Group's accounting policies. The areas involving a higher degree of judgment or complexity or areas where assumptions and estimates are significant to the Consolidated Financial Statements are disclosed in ► **NOTE 6 'CRITICAL ACCOUNTING ESTIMATES AND JUDGMENTS.'**

ACCOUNTING STANDARDS APPLIED FOR THE FIRST TIME IN THE CURRENT FISCAL YEAR

Due to the first-time adoption of IFRS 9 and IFRS 15 since January 1, 2018, the Group's Consolidated Financial Statements have undergone transition effects in the following areas, which led to a change in the accounting method. NORMA Group has applied the modified retrospective approach for the transition to IFRS 9 and IFRS 15. Conversion effects at the date of first-time adoption were cumulatively recognized in equity and the comparative period is presented in accordance with the previous rules.

The effects of the first-time application of IFRS 9 and IFRS 15 on retained earnings are shown below:

T 043 RETAINED EARNINGS RECONCILIATION: IFRS 9 AND IFRS 15

IN EUR THOUSANDS	Retained earnings
Retained earnings as of December 31, 2017	298,077
Effects of IFRS 9	- 600
of which loss allowances established for trade accounts receivable	- 800
of which deferred taxes	200
Effects of IFRS 15	0
Retained earnings as of January 1, 2018	297,477

The effects of the first-time application of IFRS 9 and IFRS 15 on the Consolidated Statement of Financial Position as well as the impact on the Consolidated Statement of Comprehensive Income as of December 31, 2018, are shown below:

T 044 RECONCILIATION CONSOLIDATED STATEMENT OF FINANCIAL POSITION IFRS 9 AND IFRS 15

IN EUR THOUSANDS	Dec 31, 2017 as originally presented	IFRS 9	IFRS 15	Jan 1, 2018 restated
Non-current assets				
Deferred income tax assets	4,845	200		5,045
Other non-current assets	820,608			820,608
	825,453	200	0	825,653
Current assets				
Inventories	151,229			151,229
Trade and other receivables	152,746	- 813	- 1,051	150,882
Contract assets	0		1,051	1,051
Cash and cash equivalents	155,323			155,323
Other current assets	27,279			27,279
	486,577	- 813	0	485,764
Total assets	1,312,030	- 613	0	1,311,417
Equity				
Retained earnings	298,077	- 600		297,477
Other equity	236,244	- 13		236,231
	534,321	- 613	0	533,708
Liabilities				
Non-current liabilities				
Deferred income tax liabilities	60,543			60,543
Other non-current liabilities	483,416			483,416
	543,959	0	0	543,959
Current liabilities				
Other non-financial liabilities	31,860		- 193	31,667
Contract liabilities	0		193	193
Other current liabilities	201,890			201,890
	233,750	0	0	233,750
Total liabilities	777,709	0	0	777,709
Total equity and liabilities	1,312,030	- 613	0	1,311,417

T 045 RECONCILIATION CONSOLIDATED STATEMENT OF COMPREHENSIVE INCOME IFRS 9 AND IFRS 15

IN EUR THOUSANDS	2018	Effects of IFRS 15			2018 without IFRS 15/ IFRS 9
		Change of presentation	Changes in timing of recognition	Effects of IFRS 9	
Revenue	1,084,140	2,719			1,081,421
Changes in inventories of finished goods and work in progress	10,383				10,383
Other own work capitalized	5,197				5,197
Raw materials and consumables used	- 473,551				- 473,551
Gross profit	626,169	2,719	0	0	623,450
Other operating income	15,589	- 2,719			18,308
Other operating expenses	- 162,016			- 62	- 161,954
Employee benefits expense	- 282,768				- 282,768
Depreciation and amortization	- 63,429				- 63,429
Operating profit	133,545	0	0	- 62	133,607
Financial income	2,703				2,703
Financial costs	- 14,371				- 14,371
Financial costs – net	- 11,668	0	0	0	- 11,668
Profit before income tax	121,877	0	0	- 62	121,939
Income taxes	- 30,089			19	- 30,108
Profit for the period	91,788	0	0	- 43	91,831
Other comprehensive income for the period, net of tax					
Other comprehensive income that can be reclassified to profit or loss, net of tax	10,749	0	0	0	10,749
Exchange differences on translation of foreign operations	10,068				10,068
Cash flow hedges, net of tax	681				681
Other comprehensive income that cannot be reclassified to profit or loss, net of tax	- 214	0	0	0	- 214
Remeasurements of post-employment benefit obligations, net of tax	- 214				- 214
Other comprehensive income for the period, net of tax	10,535	0	0	0	10,535
Total comprehensive income for the period	102,323	0	0	- 43	102,366
Profit attributable to					
Shareholders of the parent	91,873	0	0	- 43	91,916
Non-controlling interests	- 85	0	0	0	- 85
	91,788	0	0	- 43	91,831
Total comprehensive income attributable to					
Shareholders of the parent	102,540	0	0	- 43	102,583
Non-controlling interests	- 217	0	0	0	- 217
	102,323	0	0	- 43	102,366
(Un)diluted earnings per share (in EUR)	2.88	0	0	0	2.88

106 Consolidated
Statement of
Comprehensive
Income107 Consolidated
Statement of
Financial Position108 Consolidated
Statement of
Cash Flows109 Consolidated
Statement of
Changes in Equity**110 Notes to the
Consolidated Financial
Statements**197 Appendix to the Notes
to the Consolidated
Financial Statements200 Responsibility
Statement201 Independent
Auditor's Report**IFRS 9****Classification and valuation of financial assets**

The classification and measurement of part of the portfolio of trade receivables available for sale under the ABS and factoring program has changed from the previous valuation at amortized cost (AC) to fair value through profit or loss (FVTPL).

Impairment model for financial assets

IFRS 9 also introduces a new impairment model for financial assets measured at amortized cost. This replaces the previous model based on incurred losses (incurred loss model) with a model based on expected losses (expected loss model). For trade receivables, the simplified procedure is based on the expected credit losses over the respective terms. Loss rates are calculated on the basis of historical and forecast data, taking into account the business model, the respective customer and the economic environment of the geographical region. Receivables with significant overdue dates, which due to the customer structure can also exceed 180 days, or those over whose debtors' insolvency or comparable proceedings have been opened, are individually examined for impairment. If it cannot be reasonably assumed that these are realizable, they are written off immediately.

For bank balances and other financial receivables that are not classified as at fair value through profit or loss, the general impairment rules of IFRS 9 are applied, however the identified impairment loss was insignificant.

Contract assets relating to work in progress not yet invoiced have essentially the same risk characteristics as trade receivables for the same customer.

Hedge accounting

With regard to hedge accounting, IFRS 9 provides for the elimination of the thresholds to be applied in the retrospective effectiveness test. Instead, proof of the economic connection between the underlying transaction and the hedging instrument must be provided. The scope of possible underlying transactions and the notes on hedge accounting have also been extended. The new regulations on hedge accounting are applied prospectively. All current hedging relationships meet the requirements for hedge accounting in accordance with IFRS 9 and can be continued as before.

The following table contains a reconciliation of the carrying amounts of financial instruments, broken down by the classes of the Consolidated Statement of Financial Position and categories in accordance with IFRS 9 to the previous categories in accordance with IAS 39.

T046 FINANCIAL ASSETS RECONCILIATION FROM IAS 39 TO IFRS 9

IN EUR THOUSANDS	Category IFRS 7.8 in accordance with IFRS 9	Carrying amount Dec 31, 2018	Carrying amount Jan 1, 2018	Category IFRS 7.8 in accordance with IAS 39	Carrying amount Dec 31, 2017
Financial assets					
Derivative financial instruments - hedge accounting					
Interest rate swaps – cash flow hedges	n/a	2,571	1,885	n/a	1,885
Foreign exchange derivatives – cash flow hedges	n/a	151	458	n/a	458
Foreign exchange derivatives – fair value hedges	n/a	42	182	n/a	182
Trade and other receivables ¹	Amortized Cost	128,485	147,854	LaR	152,746
Trade receivable – ABS/Factoring program ^{1,2}	FVTPL	14,653	4,079		
Other financial assets	Amortized Cost	5,231	1,001	LaR	1,001
Cash and cash equivalents	Amortized Cost	190,392	155,323	LaR	155,323
Financial liabilities					
Borrowings	FLAC	569,091	488,247	FLAC	488,247
Derivative financial instruments - hedge accounting					
Interest rate swaps – cash flow hedges	n/a	675	1,226	n/a	1,226
Foreign exchange derivatives – cash flow hedges	n/a	45	43	n/a	43
Foreign exchange derivatives – fair value hedges	n/a	38	150	n/a	150
Trade and other payables	FLAC	142,028	145,749	FLAC	145,749
Other financial liabilities					
Other liabilities	FLAC	20,826	10,375	FLAC	10,375
Finance lease liabilities	n/a	32	156	n/a	156
Totals per category					
Financial assets at amortized cost		324,108	304,178	LaR	309,070
Financial assets at fair value through profit or loss (FVTPL)		14,653	4,079		
Financial liabilities at amortized cost (FLAC)		731,945	644,371	FLAC	644,371

1_The change in measurement basis as a result of IFRS 9 affects trade receivables.

2_The reclassification under IFRS 9 relates to trade receivables that are available for sale under the ABS and Factoring programs.

The allowance for trade receivables as of December 31, 2017, is reconciled to the opening balance sheet value of the allowance as of January 1, 2018, as follows:

T 047 IMPAIRMENT RECONCILIATION FROM IAS 39 TO IFRS 9

IN EUR THOUSANDS	Impairments on trade receivables
Impairment allowance as of Dec 31, 2017 – based on IAS 39	2,551
Reclassification of write-offs based on IFRS 9.5.4.4	-1,793
Amounts adjusted retroactively through the opening balance of retained earnings	813
Impairment allowance as of Jan 1, 2018 – based on IFRS 9	1,571

IFRS 15

The adoption of IFRS 15 has resulted in the following effects:

Disclosure changes

In order to comply with the methodology of IFRS 15, NORMA Group has adjusted the presentation of certain items in the Consolidated Statement of Financial Position and the Consolidated Statement of Comprehensive Income.

- ▶ Amounts already received (or to be received) that are expected to be reimbursed to the customer are reported as refund liabilities in accordance with IFRS 15. These liabilities are included in the Consolidated Statement of Financial Position item 'Trade and other payables.' These amounts generally relate to expected volume discounts and were also previously reported under this item and other provisions.
- ▶ Advance payments received (or to be received) in connection with product deliveries were previously reported under other non-financial liabilities. Advance payments received (or to be received) from service contracts that are recognized over a period of time were previously reported as deferred items under other non-financial liabilities. With the introduction of IFRS 15, both are reported as contract liabilities. In the Consolidated Statement of Cash Flows, the reduction in other non-financial liabilities resulting from the change in presentation is offset by a corresponding change in other net assets.
- ▶ The receivables from the application of the percentage of completion method reported under trade and other receivables meet the requirements for period related revenue recognition in accordance with IFRS 15 and are reported as contract assets with the introduction of IFRS 15.

Besides the first time adoption of IFRS 9 and IFRS 15, the following new standards or amendments to standards were applied for the first time for the fiscal year 2018. These had no material impact on NORMA Group's financial position, cash flows or financial performance.

Amendments to IFRS 2: Clarification on: Valuation, Classification and Modification

On June 20, 2016, the IASB issued amendments to IFRS 2, Share-based Payment, clarifying how to account for certain types of share-based payment transactions.

The amendments provide requirements on the accounting for the following areas:

Consideration of conditions of performance (terms of service, market conditions and other performance conditions) within the framework of the valuation of cash settled share-based payments

Under the new regulations, market conditions and non-exercisable conditions must be taken into account when estimating the fair value. Service conditions and other performance conditions must be considered when estimating the number of awards expected to vest.

Classification of share-based payment transactions with a net settlement feature for withholding tax obligations

If a company reduces the number of equity instruments to be delivered otherwise because it is obliged to withhold the number of equity instruments equal to the monetary value of the employee's tax obligation, and if this net compensation is provided for in the contract, the remuneration is – in spite of this partial payment – classified in its entirety as an equity-settled share-based payment transaction.

Accounting for a modification in the terms and conditions of a share-based payment that changes the transaction from cash-settled to equity-settled

The equity settled share-based payment is recognized at the modification date fair value of the equity instrument granted to the extent that services have been rendered up to the modification date. The cash-settled award is remeasured, with any difference recognized in the income statement before the remeasured liability is reclassified into equity.

Entities are required to apply the amendments for annual periods beginning on or after January 1, 2018. Early application is permitted. The Group is currently examining the effects of applying IFRS 2 to its Consolidated Financial Statements.

106	Consolidated Statement of Comprehensive Income
107	Consolidated Statement of Financial Position
108	Consolidated Statement of Cash Flows
109	Consolidated Statement of Changes in Equity
110	Notes to the Consolidated Financial Statements
197	Appendix to the Notes to the Consolidated Financial Statements
200	Responsibility Statement
201	Independent Auditor's Report

Annual Improvement Project to IFRS Cycle: 2014 – 2016

In December 2016, the IASB conducted the cycle as part of the Annual Improvement Project 2014 – 2016, which provides various amendments to existing standards. The cycle: 2014 – 2016 contains clarifications for three standards, IFRS 1, IFRS 12 and IAS 28. The amendments are intended for clarification purposes and not for any fundamental changes in accounting practice. As a result, the Group does not expect any material effects on its Consolidated Financial Statements.

STANDARDS, AMENDMENTS AND INTERPRETATIONS OF EXISTING STANDARDS THAT ARE NOT YET EFFECTIVE AND HAVE NOT BEEN ADOPTED EARLY BY THE GROUP

The following standards and amendments to existing standards have been published and application is mandatory for all accounting periods beginning on or after January 1, 2019. The Group has decided against early adoption.

1) STANDARDS, AMENDMENTS AND INTERPRETATIONS TO EXISTING STANDARDS THAT HAVE ALREADY BEEN ENDORSED BY THE EU (WITH REFERENCE TO EACH RESPECTIVE EU EFFECTIVE DATE):**IFRS 16: Leases (EU endorsement date Oct 31, 2017)**

On January 13, 2016, the IASB issued IFRS 16, Leases. The new standard is to be applied for annual periods beginning on or after January 1, 2019. In contrast to IAS 17, the lessee must present all leases in the balance sheet in the future, with only a few exceptions. For lessors, on the other hand, the previous provisions of IAS 17 will be continued. In other words, they still have to differentiate between finance leases and operating leases. NORMA Group will apply IFRS 16 for the first time in the fiscal year beginning on January 1, 2019, according to the modified retrospective method. Hence, the cumulative effect of initially applying IFRS 16 is recognized as an adjustment in equity against retained earnings on the date of initial application and the comparative figures for the previous reporting period are not changed. For previous operating leases that do not end in 2019, the Group recognizes a lease liability as of January 1, 2019, in the amount of the present value of the future lease payments (taking into account any extension options). The corresponding right of use assets are calculated as if IFRS 16 had been applied from the inception of the lease. Both the right of use assets and the future lease payments are discounted at the lessee's incremental borrowing rate at the date of initial application.

For the majority of leases, the Group as lessee recognizes a right of use asset under IFRS 16 and a corresponding lease liability. The lease liability has to be compounded in the subsequent valuation and the right of use asset has to be depreciated. In addition to the resulting balance sheet extension, under IFRS 16 there

is a reclassification within the Statement of Comprehensive Income of the leasing instalments previously recognized as operating expenses to depreciation and interest expense and thus an increase in EBITDA (by the full reclassification effect) as well as EBITA and EBIT (by the reclassification effect attributable to interest). Under IFRS 16, the principal payments on the lease liability are presented within financing activities in the cash flow statement. As a result, cash flow from operating activities will increase accordingly and cash flow from financing activities will decrease accordingly.

Exceptions in the form of accounting options exist for short-term leases (minimum term of a maximum of twelve months if no purchase option has been agreed) and for low-value assets. The lease payments resulting from these leases will therefore remain part of operating expenses in the future. NORMA Group will make use of these application simplifications as lessee, with the exception of leased assets which are allocated to the asset class 'Right of use assets - land and buildings.' In addition, lessees are given the option of not having to separate leasing and non-leasing components, which NORMA Group will make use of except for the asset classes 'Right of use assets - land and buildings' and 'Right of use assets – company cars.'

On the date of initial application, lease liabilities totaling around EUR 33 million will be recognized in the consolidated balance sheet. These exceed the future minimum lease payments of EUR 21,905 thousand reported as of December 31, 2018, from non-cancellable operating leases. ► **NOTE 31. 'COMMITMENTS'** The reason for this is higher balance sheet leasing liabilities, which arise mainly in the area of real estate leasing due to the consideration of rental extension options. Retained earnings will decrease by around EUR 3 million at the time of first-time application (without taking deferred taxes into account), as the total of the rights of use to be capitalized at the time of first-time application is lower than the leasing liabilities carried as liabilities. The equity ratio will decrease slightly due to the balance sheet extension. Based on the leases existing as of January 1, 2019, Group EBITA for fiscal year 2019 is expected to increase by EUR 1 million.

106 Consolidated
Statement of
Comprehensive
Income107 Consolidated
Statement of
Financial Position108 Consolidated
Statement of
Cash Flows109 Consolidated
Statement of
Changes in Equity**110 Notes to the
Consolidated Financial
Statements**197 Appendix to the Notes
to the Consolidated
Financial Statements200 Responsibility
Statement201 Independent
Auditor's Report**IFRIC 23: Uncertainty over Income Tax Treatments**

In June 2017, the IASB issued IFRIC 23, Uncertainty over Income Tax Treatments. The interpretation clarifies the recognition and measurement requirements when there is uncertainty over income tax treatments. In assessing the uncertainty, an entity shall consider whether it is probable that a taxation authority will accept the uncertain tax treatment. IFRIC 23 is effective for annual reporting periods beginning on or after January 1, 2019, while earlier application is permitted. The Company does not expect a material impact on NORMA Group's financial position, cash flows or financial performance.

2) STANDARDS, AMENDMENTS AND INTERPRETATIONS TO EXISTING STANDARDS THAT HAVE NOT BEEN ENDORSED BY THE EU:**Amendments to IAS 19: Plan amendment, curtailment or settlement**

On February 7, 2018, the IASB issued amendments to IAS 19 - plan amendment, curtailment or settlement. The amendments to IAS 19 Employee Benefits now explicitly state that after an amendment, curtailment or settlement of a pension plan during the year, the current service cost and the net interest for the remaining period must be recalculated. The actuarial assumptions valid at the time of the planned event must be used for this recalculation.

The amendments should be applied prospectively to plan amendments, curtailments or settlements that occur on or after January 1, 2019, with earlier application permitted. However, before the first application, the outstanding endorsement still has to be permitted by the EU.

Amendments to IFRS 3: Definition of a business

On October 22, 2018, the IASB issued amendments to the guidance in IFRS 3, 'Business Combinations' that revises the definition of a business.

With this amendment, the IASB clarifies that a business comprises a group of activities and assets that include at least one resource, input, and one substantive process, which together significantly contribute to the ability to create outputs. Furthermore, in terms of outputs, now the focus is on goods and services provided to customers; the reference to cost reductions is omitted. The new regulations also include an optional 'concentration test,' which should enable a simplified identification of a business operation.

These amendments shall be applied for acquisitions occurring during annual periods beginning on or after January 1, 2020, while earlier application is permitted. However, first-time adoption within the EU prior to endorsement is not permitted.

In December 2017, the IASB conducted the cycle as part of the Annual Improvement Project 2015–2017, which provides various amendments to existing standards. The cycle: 2015–2017 contains clarifications for three standards, IFRS 3 and IFRS 11, IAS 12 and IAS 23. The amendments and IAS are effective for annual periods beginning on or after January 1, 2019.

The amendments are intended for clarification purposes and not for any fundamental changes in accounting practice. As a result, the Group does not expect any material effects on its Consolidated Financial Statements.

The IASB has published a number of other pronouncements. These recently translated accounting pronouncements as well as the pronouncements which have not yet been implemented have no material effect on the Consolidated Financial Statements of NORMA Group.

106	Consolidated Statement of Comprehensive Income
107	Consolidated Statement of Financial Position
108	Consolidated Statement of Cash Flows
109	Consolidated Statement of Changes in Equity
110	Notes to the Consolidated Financial Statements
197	Appendix to the Notes to the Consolidated Financial Statements
200	Responsibility Statement
201	Independent Auditor's Report

3. SUMMARY OF SIGNIFICANT ACCOUNTING PRINCIPLES

CONSOLIDATION

(a) Subsidiaries

Subsidiaries are all entities (including structured entities) over which the Group has control. The Group controls an entity when the Group is exposed to, or has rights to, variable returns from its involvement with the entity and has the ability to affect those returns through its power over the entity. Consolidation of an investee begins from the date the Group obtains control of the investee and ceases when the Group loses control of the investee.

The Group uses the acquisition method of accounting to account for business combinations. The initial value for the acquisition of a subsidiary is recognized at fair value of the assets transferred, the liabilities incurred and the equity interests issued by the Group. The initial value recognized includes the fair value of any asset or liability resulting from a contingent consideration arrangement. On the acquisition date, the fair value of the contingent consideration is recognized as part of the consideration transferred in exchange for the acquiree. Acquisition-related costs are expensed as incurred. Identifiable assets acquired and liabilities and contingent liabilities assumed in a business combination are measured initially at their fair value on the acquisition date. According to IFRS 3, for each business combination, the acquirer shall measure any non-controlling interest in the acquiree either at fair value (full goodwill method) or at the non-controlling interest's proportionate share of the acquiree's net assets. The Group measures the non-controlling interest in the acquiree at the non-controlling interest's proportionate share of the acquiree's net assets.

The excess of the consideration transferred, the amount of any non-controlling interest in the acquiree and the acquisition date fair value of any previous equity interest in the acquiree over the fair value of the Group's share of the identifiable net assets acquired, is recorded as goodwill. If this is less than the fair value of the net assets of the subsidiary acquired in the case of a bargain purchase, the difference is recognized immediately in the Consolidated Statement of Comprehensive Income.

In a business combination achieved in stages, the Group remeasures its previously held equity interest in the acquiree at its acquisition date fair value and recognizes the resulting gain or loss, if any, in profit or loss.

Intercompany transactions, balances and unrealized gains or losses on transactions between Group companies are eliminated. Accounting policies of subsidiaries have been changed where necessary to ensure consistency with the policies adopted by the Group.

(b) Non-controlling interests

Non-controlling interests have a share in the earnings of the reporting period. Their interests in the shareholders' equity of subsidiaries are reported separately from the equity of the Group.

The Group treats transactions with non-controlling interests that do not result in a loss of control as transactions with equity owners of the Group. For purchases from non-controlling interests, the difference between any consideration paid and the relevant share acquired of the carrying value of net assets of the subsidiary is recorded in equity.

(c) Disposal of subsidiaries

When the Group ceases to have control, any retained interest in the subsidiary is remeasured at its fair value, with the change in the carrying amount recognized in profit or loss. The initial carrying amount is the fair value for the purposes of subsequently accounting for the retained interest as an associate, joint venture or financial asset. In addition, any amounts previously recognized in other comprehensive income in respect of that entity are accounted for as if the Group had directly disposed of the related assets or liabilities. This may mean that amounts previously recognized in other comprehensive income are reclassified to profit or loss.

106 Consolidated Statement of Comprehensive Income

107 Consolidated Statement of Financial Position

108 Consolidated Statement of Cash Flows

109 Consolidated Statement of Changes in Equity

110 Notes to the Consolidated Financial Statements

197 Appendix to the Notes to the Consolidated Financial Statements

200 Responsibility Statement

201 Independent Auditor's Report

VALUATION METHODS

The following table shows the most important valuation methods:

T 048 VALUATION METHODS

Position	Valuation method
Assets	
Goodwill	Acquisition costs less potential impairment
Other intangible assets (except goodwill) – finite useful lives	Amortized costs
Other intangible assets (except goodwill) – indefinite useful lives	Acquisition costs less potential impairment
Property, plant and equipment	Amortized costs
Derivative financial assets:	
Classified as cash flow hedge	At fair value in other comprehensive income
Classified as fair value hedge	At fair value through profit or loss
Without hedge accounting	At fair value through profit or loss
Inventories	Lower of cost or net realizable value
Other non-financial assets	Amortized costs
Other financial assets	Amortized costs
Trade and other receivables	Amortized costs
Trade receivables available for transfer	At fair value through profit or loss
Contract assets	Percentage of completion method less potential impairment
Cash and cash equivalents	Nominal amount
Liabilities	
Pensions	Projected unit credit method
Other provisions	Present value of future settlement amount
Borrowings	Amortized costs
Other non-financial liabilities	Amortized costs
Other financial liabilities:	
Financial liabilities at cost (FLAC)	Amortized costs
Derivative financial liabilities:	
Classified as cash flow hedge	At fair value in other comprehensive income
Classified as fair value hedge	At fair value through profit or loss
Without hedge accounting	At fair value through profit or loss
Contingent consideration	At fair value through profit or loss
Trade and other payables	Amortized costs

106 Consolidated
Statement of
Comprehensive
Income107 Consolidated
Statement of
Financial Position108 Consolidated
Statement of
Cash Flows109 Consolidated
Statement of
Changes in Equity**110 Notes to the
Consolidated Financial
Statements**197 Appendix to the Notes
to the Consolidated
Financial Statements200 Responsibility
Statement201 Independent
Auditor's Report**FAIR VALUE ESTIMATION**

IFRS 7 requires for financial instruments that are measured in the Statement of Financial Position at fair value in accordance with IFRS 13 a disclosure of fair value measurements by level using the following fair value measurement hierarchy:

Level 1: Quoted prices (unadjusted) in active markets for identical assets or liabilities,

Level 2: Inputs other than quoted prices included within Level 1 that are observable for the asset or liability, either directly (that is as prices) or indirectly (that is derived from prices), and

Level 3: Inputs for the asset or liability that are not based on observable market data (that is unobservable inputs).

The level in the fair value hierarchy within which the fair value measurement is categorized in total is determined on the basis of the lowest level input that is significant to the fair value measurement in total. The different hierarchy levels demand different amounts of disclosure.

On December 31, 2018, and 2017, the Group's derivative financial instruments carried in the Statement of Financial Position at fair value (e. g. derivatives used for hedging) are categorized in total within Level 2 of the fair value hierarchy. The fair value of interest rate swaps is calculated as the present value of the estimated future cash flows. The fair value of forward foreign exchange contracts is determined using a present value model based on forward exchange rates.

FOREIGN CURRENCY TRANSLATION**(a) Functional and presentation currency**

Items included in the financial statements of each of the Group's entities are measured using the currency of the primary economic environment in which the entity operates ('the functional currency'). The Consolidated Financial Statements are prepared in 'euros' (EUR), which is NORMA Group SE's functional and the Group's presentation currency.

(b) Transactions and balances

Foreign currency transactions are translated into the functional currency using the actual exchange rates on the dates of the transactions or valuation where items are remeasured. Foreign exchange gains and losses resulting from the settlement of such transactions and from the translation at year-end exchange rates of monetary assets and liabilities denominated in foreign currencies are recognized in profit or loss.

Foreign exchange gains and losses that relate to borrowings and cash and cash equivalents are presented in profit or loss within 'financial income/costs.' All other foreign exchange gains and losses are presented in profit or loss within 'other operating income/expenses.'

(c) Group companies

The results and financial position of all the Group entities (none of which has the currency of a hyper-inflationary economy) that have a functional currency different from the presentation currency are translated into the presentation currency as follows:

- ▶ Assets and liabilities for each Consolidated Statement of Financial Position presented are translated at the closing rate on the date of that Consolidated Statement of Financial Position;
- ▶ Income and expenses are translated at average exchange rates (unless this average is not a reasonable approximation of the cumulative effect of the rates prevailing on the transaction dates, in which case income and expenses are translated at the actual rate on the dates of the transactions); and
- ▶ All resulting exchange differences are recognized as a separate component of equity.

Goodwill and fair value adjustments arising through the acquisition of a foreign entity are treated as assets and liabilities of the foreign entity and translated at the closing rate.

The exchange rates of the currencies affecting foreign currency translation are as follows:

T049 EXCHANGE RATES

PER EUR	Spot rate		Average rate	
	Dec 31, 2018	Dec 31, 2017	2018	2017
Australian dollar	1.6220	1.5346	1.5803	1.4734
Brazilian real	4.4440	3.9729	4.3071	3.6079
Chinese renminbi yuan	7.8751	7.8044	7.8065	7.6286
Swiss franc	1.1269	1.1702	1.1550	1.1119
Czech koruna	25.7240	25.5350	25.6468	26.3239
British pound sterling	0.8945	0.8872	0.8847	0.8765
Indian rupee	79.7298	76.6055	80.6760	73.5079
Japanese yen	125.8500	135.0100	130.3588	126.7032
South Korean won	1,277.9300	1,279.6100	1,298.7919	1,276.3595
Malaysian ringgit	4.7317	4.8536	4.7630	4.8514
Mexican peso	22.4921	23.6612	22.7001	21.3372
Polish zloty	4.3014	4.1770	4.2612	4.2563
Serbian dinar	118.2690	118.3430	118.2359	121.3254
Russian ruble	79.7153	69.3920	74.0428	65.9190
Swedish krona	10.2548	9.8438	10.2611	9.6378
Singapore dollar	1.5591	1.6024	1.5924	1.5586
Thai baht	37.0520	39.1210	38.1559	38.2903
Turkish lira	6.0588	4.5464	5.6960	4.1226
US dollar	1.1450	1.1993	1.1810	1.1297

INTANGIBLE ASSETS

(a) Goodwill

Goodwill represents the excess of the cost of an acquisition over the fair value of the Group's share of the net identifiable assets of the acquired subsidiary on the date of acquisition. Goodwill on acquisitions of subsidiaries is included in 'intangible assets.' Goodwill is tested annually for impairment and carried at cost less accumulated impairment losses. Impairment losses on goodwill are not reversed. Gains and losses on the disposal of an entity include the carrying amount of goodwill relating to the entity sold.

Goodwill is allocated to cash-generating units for the purpose of impairment testing. The allocation is made to those cash-generating units or groups of cash-generating units that are expected to benefit from the business combination in which the goodwill arose.

(b) Development costs

Costs of research activities undertaken with the prospect of gaining new scientific or technical knowledge and understanding are expensed as incurred.

Costs for development activities, whereby research findings are applied to a plan or design for the production of new or substantially improved products and processes, are capitalized if development costs can be measured reliably, the product or process is technically and commercially feasible and future economic benefits are probable.

Furthermore, NORMA Group intends, and has sufficient resources, to complete development and use or sell the asset. The costs capitalized include the cost of materials, direct labor and other directly attributable expenditure that serves to prepare the asset for use. Such capitalized costs are included in profit or loss in line 'own work capitalized.' Capitalized development costs are stated at cost less accumulated amortization and impairment losses with an amortization period of generally three to five years. Development costs which did not meet the requirements are expensed as incurred.

(c) Other intangible assets

Separately acquired other intangible assets are shown at historical cost less accumulated amortization. Intangible assets acquired in a business combination are recognized at fair value on the acquisition date. Other intangible assets which have a finite useful life will be amortized over their estimated useful life. Amortization is calculated using the straight-line method to allocate their cost. Other intangible assets which are determined to have indefinite useful lives as well as intangible assets not yet available for use are not amortized, but instead tested for impairment at least annually. Furthermore, other intangible assets which are determined to have indefinite useful lives and therefore are not amortized, will be reviewed each period to determine whether events and circumstances continue to support an indefinite useful life assessment for these assets.

106 Consolidated Statement of Comprehensive Income

107 Consolidated Statement of Financial Position

108 Consolidated Statement of Cash Flows

109 Consolidated Statement of Changes in Equity

110 Notes to the Consolidated Financial Statements

197 Appendix to the Notes to the Consolidated Financial Statements

200 Responsibility Statement

201 Independent Auditor's Report

In general, the Group's other intangibles are not qualifying assets in accordance with IAS 23 and borrowing costs eligible for capitalization therefore do not exist.

The useful lives of other intangible assets acquired in a business combination are estimates based on the economics of each specific asset which were determined in the process of the purchase price allocation. The major part of these assets are brand names and customer lists.

The estimated useful lives for other intangible assets are as follows:

- ▶ Patents: 5 to 10 years
- ▶ Customer lists: 4 to 20 years
- ▶ Technology: 10 to 20 years
- ▶ Licenses, rights: 3 to 5 years
- ▶ Trademarks: indefinite or 20 years
- ▶ Software: 3 to 5 years
- ▶ Development costs: 3 to 5 years

Other intangible assets with indefinite useful lives are essentially brand names, for which the end of usability is not foreseeable and therefore indeterminable. These brand names result from acquisitions. For these brand names, an indefinite useful life is assumed. Based on a market perspective, there are no clear indications for a definite useful life of these brand names as they have been well-established in the market for many years.

PROPERTY, PLANT AND EQUIPMENT

All property, plant and equipment are stated at historical cost less depreciation and impairment loss, if substantial. Historical cost includes expenditure that is directly attributable to the acquisition of the items and, if any, the present value of estimated costs for dismantling and removing the assets, restoring the site on which it is allocated. Borrowing costs eligible for capitalization in the sense of IAS 23 were not available.

Subsequent costs are included in the asset's carrying amount or recognized as a separate asset, as appropriate, only when it is foreseeable that future economic benefits associated with the item will flow to the Group and the cost of the item can be measured reliably. The carrying amount of the replaced part is derecognized. All other repairs and maintenance expenses are charged to profit or loss during the financial period in which they are incurred.

Land is not depreciated. Depreciation on other assets is calculated using the straight-line method to allocate their cost to their residual values over their estimated useful lives.

The assets' residual values and useful lives are reviewed and adjusted, if appropriate, on each balance sheet date.

An asset's carrying amount is written down to its recoverable amount if the asset's carrying amount is greater than its estimated recoverable amount.

Gains and losses on disposals are determined by comparing the proceeds with the carrying amount and are recognized within 'other operating income/expenses.'

The estimated useful lives for property, plant and equipment are as follows:

- ▶ Buildings: 8 to 40 years
- ▶ Machinery and technical equipment: 3 to 18 years
- ▶ Tools: 3 to 10 years
- ▶ Other equipment: 2 to 20 years

106 Consolidated
Statement of
Comprehensive
Income107 Consolidated
Statement of
Financial Position108 Consolidated
Statement of
Cash Flows109 Consolidated
Statement of
Changes in Equity**110 Notes to the
Consolidated Financial
Statements**197 Appendix to the Notes
to the Consolidated
Financial Statements200 Responsibility
Statement201 Independent
Auditor's Report**IMPAIRMENT OF NON-FINANCIAL ASSETS****(a) Assets with a finite useful life**

For assets with a finite useful life, an impairment test is needed if there are indications that those assets may be impaired. If such indications exist, the amortized carrying value of the asset is compared to the recoverable amount, which is the higher of an asset's fair value less costs to sell and its value in use. The value in use is the discounted present value of future cash flows expected to arise from the continuing use of the asset. In the case of an impairment, the difference between the amortized carrying amount and the lower recoverable amount is recognized as an expense in profit or loss. If evidence exists that the reasons for the impairment no longer exist, the impairment loss is reversed. The reversal cannot result in an amount exceeding amortized cost.

(b) Goodwill and other assets with an indefinite useful life

Moreover, other intangible assets with an indefinite useful life, other intangible assets not yet ready for use or advance payments on such assets as well as goodwill must be tested for impairment annually. A test is also performed whenever there is any indication that an asset might be impaired. Where the reasons for an impairment no longer exist, the impairment loss is reversed, except in the case of goodwill.

The recoverable amount is determined for each individual asset, unless an asset generates cash inflows that are not largely independent of those from other assets or other groups of assets or cash-generating units. In these cases, the impairment test is performed at the relevant level of cash-generating units to which the asset is attributable.

Goodwill acquired in a business combination is allocated at the acquisition date to the cash-generating unit or group of cash-generating units that are expected to profit from the synergies deriving from the business combination. This also represents the lowest level at which goodwill is monitored for internal management purposes. These are the operating and reportable segments EMEA, Americas and Asia-Pacific.

There is currently no goodwill in the Group that can be directly allocated to an individual entity because this reflects the enterprise value of the acquired entity regardless of the transaction.

The Company normally determines the recoverable amount using measurement methods based on discounted cash flows.

Brand names with indefinite useful lives acquired in business combinations are tested for impairment at the level at which a recoverable amount, which is based on the fair value less costs to sell, can be determined.

For cash-generating units, NORMA Group first determines the relevant recoverable amount as fair value less costs to sell, which it compares with the respective carrying amounts, including allocated goodwill in the case of impairment tests on goodwill. For further details regarding the determination of the fair value less costs to sell and the underlying assumptions, we refer to ► **NOTE 18 'GOODWILL AND OTHER INTANGIBLE ASSETS.'**

INVENTORIES

Inventories are stated at the lower of cost or net realizable value. Net realizable value is the estimated selling price in the ordinary course of business, less the estimated costs of completion and the estimated variable selling costs. Cost is determined using the weighted average method. The cost of finished goods and work in progress comprises design costs, raw materials, direct labor, other direct costs and related production overheads (based on normal operating capacity). Inventories of the Group are not qualifying assets in accordance with IAS 23, so that the acquisition or production costs do not include capitalized borrowing costs.



106 Consolidated
Statement of
Comprehensive
Income107 Consolidated
Statement of
Financial Position108 Consolidated
Statement of
Cash Flows109 Consolidated
Statement of
Changes in Equity**110 Notes to the
Consolidated Financial
Statements**197 Appendix to the Notes
to the Consolidated
Financial Statements200 Responsibility
Statement201 Independent
Auditor's Report**FINANCIAL INSTRUMENTS****(a) Financial assets****Classification**

From January 1, 2018, on, the Group classifies its financial assets in the following measurement categories:

- ▶ Debt instruments measured at amortized cost (AC);
- ▶ Debt instruments measured at fair value through equity (FVOCI), with cumulative gains and losses reclassified to the income statement when the financial asset is derecognized;
- ▶ Debt, derivative and equity instruments at fair value through profit or loss (FVTPL);
- ▶ Equity instruments classified as FVOCI, with gains and losses remaining in other comprehensive income (OCI) (without reclassification).

The classification depends on the business model according to which NORMA Group manages its financial assets and the characteristics of the contractual cash flows of these financial assets.

NORMA Group reclassifies debt instruments only when the business model for managing such financial assets changes.

Recognition and derecognition

Regular purchases and sales of financial assets are recognized on the trade date – the date on which the Group commits to purchase or sell the asset. Financial assets are derecognized when the rights to receive cash flows have expired or been transferred and the Group has transferred substantially all risks and rewards of ownership.

Measurement

Financial assets are initially recognized at fair value plus transaction costs for all financial assets not carried at fair value through profit or loss.

Debt instruments

The subsequent measurement of debt instruments depends on the Group's business model for managing the financial asset and the cash flow characteristics of the financial asset.

A debt instrument is measured at amortized cost if the objective of the business model is to hold the financial asset in order to collect the contractual cash flows and the contractual cash flows from the financial asset represent only principal and interest payments and the fair value option is not exercised at inception. Interest income from these financial assets is reported under financial income using the effective interest method. Gains and losses from derecognition, impairment and currency translation are recognized directly in the Consolidated Statement of Comprehensive Income and reported in other operating income/expenses.

A debt instrument that is held in a business model in which both the contractual cash flows of financial assets are received and financial assets are sold, and in which the contractual cash flows include only principal and interest payments, is measured at fair value with no effect on income, unless the fair value option is exercised upon initial recognition. Changes in the carrying amount are recognized in other comprehensive income, except for impairment gains or losses, interest income and gains and losses on currency translation, which are recognized directly in the Consolidated Statement of Comprehensive Income. When the financial asset is derecognized, the cumulative gain or loss recognized in other comprehensive income is reclassified from equity to the Consolidated Statement of Comprehensive Income. Interest income from these financial assets is recognized in financial income using the effective interest method. Gains and losses from currency translation are recognized directly in the Consolidated Statement of Comprehensive Income and reported in other operating income/expenses.

The impairment losses recognized in the Consolidated Statement of Comprehensive Income are disclosed separately in the section "Notes to the Statement of Comprehensive Income."

All other debt instruments that do not meet these two conditions must be measured at fair value through profit or loss (FVTPL).

106 Consolidated Statement of Comprehensive Income

107 Consolidated Statement of Financial Position

108 Consolidated Statement of Cash Flows

109 Consolidated Statement of Changes in Equity

110 Notes to the Consolidated Financial Statements

197 Appendix to the Notes to the Consolidated Financial Statements

200 Responsibility Statement

201 Independent Auditor's Report

Equity instruments

All equity instruments are subsequently measured at fair value. If an equity instrument is not held for trading purposes, NORMA Group may, at the time of initial recognition, make the irrevocable decision to measure it at fair value with recognition of changes in value in other comprehensive income (FVTOCI), whereby only income from dividends is recognized in profit or loss for the period unless it represents a capital repayment.

Changes in the fair value of financial assets at fair value through profit or loss are recognized in the Consolidated Statement of Comprehensive Income under other operating income/expenses.

Impairments

As of January 1, 2018, NORMA Group assesses on a forward-looking basis the expected credit losses associated with its debt instruments, which are measured at amortized cost or at fair value with no effect on income.

The Group has three types of financial assets subject to this new model:

- ▶ Trade receivables from the sale of goods and the rendering of services,
- ▶ Contract assets from research and development activities; and
- ▶ Other debt instruments measured at amortized cost

In the case of trade receivables, NORMA Group applies the simplified approach provided for in IFRS 9, which requires the recognition of expected credit losses over the term of the receivables from their initial recognition; further details can be found in ▶ **NOTE 20 (A) 'TRADE AND OTHER RECEIVABLES.'**

Receivables which are significantly overdue, which can be more than 180 days due to the customer structure, or those whose debtors were subject to insolvency or similar proceedings, are individually tested for impairment.

The criteria that the Group uses to determine if there is objective evidence of an impairment loss include:

- ▶ A breach of contract, such as a default or delinquency in interest or principal payments;
- ▶ The Group, for economic or legal reasons relating to the borrower's financial difficulty, granting to the borrower a concession that the lender would not otherwise consider;
- ▶ It becomes probable that the borrower will enter bankruptcy or other financial reorganization.

For cash and cash equivalents, receivables from the ABS program and factoring (both from purchase price retentions), and other receivables, mainly from banker's acceptance bills for trade receivables, NORMA Group applies the general impairment approach. As it is our policy to only invest in high-quality assets of issuers with a minimum rating of at least investment grade so as to minimize the risk of credit losses, we use the low credit risk exception. Thus, these assets are always allocated to stage 1 of the three-stage credit loss model and, if material, a loss allowance for an amount equal to 12-month expected credit losses will be recorded. This loss allowance is calculated based on our exposure as of the respective reporting date, the loss given default for this exposure, and the credit default swap spread as a measure of the probability of default. To ensure that during their lifetime, our investments always fulfill the requirement of being investment-grade, we monitor changes in credit risk by tracking published external credit ratings.

Accounting policies applied until December 31, 2017 Classification

The Group classified its financial assets into the following categories: financial assets at fair value through profit or loss, loans and receivables, available for sale financial assets and financial investments held to maturity. The classification was based on the purpose for which the financial assets were acquired. Management determines the classification of financial assets at initial recognition.

Loans and receivables are non-derivative financial assets with fixed or determinable payments that are not quoted in an active market. With the exception of assets with a remaining term of more than twelve months after the reporting date, these are reported under current assets. Assets with a remaining term of more than twelve months are classified as non-current assets. The Group's loans and receivables in the balance sheet include trade and other receivables as well as cash and cash equivalents

106 Consolidated
Statement of
Comprehensive
Income107 Consolidated
Statement of
Financial Position108 Consolidated
Statement of
Cash Flows109 Consolidated
Statement of
Changes in Equity**110 Notes to the
Consolidated Financial
Statements**197 Appendix to the Notes
to the Consolidated
Financial Statements200 Responsibility
Statement201 Independent
Auditor's Report**Impairment of financial assets carried at amortized cost**

The Group assesses at the end of each reporting period whether there is objective evidence that a financial asset or group of financial assets is impaired. A financial asset or a group of financial assets is impaired and impairment losses are incurred only if there is objective evidence of impairment as a result of one or more events that occurred after the initial recognition of the asset (a 'loss event') and that loss event (or events) has (have) an impact on the estimated future cash flows of the financial asset or group of financial assets that can be reliably estimated.

The criteria that the Group uses to determine if there is objective evidence of an impairment loss include:

Financial difficulty of the issuer or obligor;

- ▶ A breach of contract, such as a default or delinquency in interest or principal payments;
- ▶ The Group, for economic or legal reasons relating to the borrower's financial difficulty, granting to the borrower a concession that the lender would not otherwise consider;
- ▶ It becomes probable that the borrower will enter bankruptcy or other financial reorganization;
- ▶ Observable data indicating that there is a measurable decrease in the estimated future cash flows from a portfolio of financial assets since the initial recognition of those assets, although the decrease cannot yet be identified with the individual financial assets in the portfolio, including
 - i. Adverse changes in the payment status of borrowers in the portfolio; and
 - ii. National or local economic conditions that correlate with defaults on the assets in the portfolio.

The Group first assesses whether objective evidence of impairment exists.

The amount of the loss is measured as the difference between the asset's carrying amount and the present value of estimated future cash flows (excluding future credit losses that have not been incurred) discounted at the financial asset's original effective interest rate. The asset's carrying amount is reduced and the amount of the loss is recognized in profit or loss. If a loan has a variable interest rate, the discount rate for measuring any impairment loss is the current effective interest rate determined under the contract.

(b) Financial liabilities

Financial liabilities primarily include trade payables, liabilities to banks, derivative financial liabilities and other liabilities.

Financial liabilities that are measured at amortized cost

After initial recognition, financial liabilities are carried at amortized cost using the effective interest method. Trade payables, liabilities to banks and other financial liabilities, in particular, are classified to this category.

106 Consolidated
Statement of
Comprehensive
Income107 Consolidated
Statement of
Financial Position108 Consolidated
Statement of
Cash Flows109 Consolidated
Statement of
Changes in Equity**110 Notes to the
Consolidated Financial
Statements**197 Appendix to the Notes
to the Consolidated
Financial Statements200 Responsibility
Statement201 Independent
Auditor's Report**Financial liabilities at fair value through profit or loss**

Financial liabilities at fair value through profit or loss include derivative financial instruments and contingent purchase price liabilities. Gains or losses on financial liabilities that are measured at fair value through profit or loss are included in profit or loss.

(c) Derivative financial instruments and hedging activities

Derivatives are initially recognized at fair value on the date a derivative contract is entered into and are subsequently remeasured at their fair value. The method of recognizing the resulting gain or loss depends on whether the derivative is designated as a hedging instrument, and if so, the nature of the item being hedged.

Derivative financial instruments not designated as hedges

Gains and losses from derivatives that are not designated as hedges (trading derivatives) are recognized in profit or loss. Trading derivatives are classified as non-current assets or liabilities in accordance with IAS 1.68 and IAS 1.71 if they have a remaining term of more than one year; otherwise they are classified as current.

Derivative financial instruments designated as hedges

Derivatives included in hedge accounting are generally designated as either:

- ▶ Hedges of the fair value of recognized assets or liabilities or firm commitments (fair value hedge);
- ▶ Hedges of a particular risk associated with a recognized asset or liability or a highly probable forecast transaction (cash flow hedge); or
- ▶ Hedges of a net investment in a foreign operation (net investment hedge).

At the inception of the transaction, NORMA documents the relationship between the hedging instruments and the hedged item, including whether changes in the cash flows of the hedging instruments offset changes in the cash flows of the hedged item. The Group documents the risk management objectives and strategies for undertaking the hedging transaction.

Further information on the instruments used by the Group and the hedging can be found in ▶ **NOTE 5 'FINANCIAL RISK MANAGEMENT'** and ▶ **20. (F) 'DERIVATIVE FINANCIAL INSTRUMENTS.'**

The development of the hedging reserve in equity can be found in ▶ **NOTE 20. (F) 'DERIVATIVE FINANCIAL INSTRUMENTS.'**

OFFSETTING FINANCIAL INSTRUMENTS

Financial assets and liabilities are offset and the net amount is reported in the Consolidated Statement of Financial Position when there is a legally enforceable right to offset the recognized amounts and an intention to settle on a net basis, or realize the asset and settle the liability simultaneously. At NORMA Group, arrangements exist which do not meet the criteria for netting in the Consolidated Statement of Financial Position according to IAS 32.42, as they allow netting only in the case of future events such as default or insolvency on the part of the Group or the counterparty.

The following tables present the recognized financial instruments that are offset, or subject to enforceable master netting arrangements and other similar agreements but not offset, as of December 31, 2018, and 2017:

T 050 OFFSETTING OF FINANCIAL INSTRUMENTS

IN EUR THOUSANDS

	Gross amounts of financial assets/ financial liabilities	Gross amounts of financial assets/ financial liabilities offset in the statement of financial position	Net amounts recognized in the statement of financial position	Amounts that are not offset in the statement of financial position Financial instruments	Net amount
Dec 31, 2018					
Financial assets					
Derivative financial instruments (b)	2,764	0	2,764	335	2,429
Trade and other receivables (a)	143,604	466	143,138	0	143,138
Other financial assets	5,231	0	5,231	0	5,231
Cash and cash equivalents	190,392	0	190,392	0	190,392
Total	341,991	466	341,525	335	341,190
Financial liabilities					
Borrowings	569,091	0	569,091	0	569,091
Derivative financial instruments (b)	758	0	758	335	423
Trade and other payables (a)	142,494	466	142,028	0	142,028
Other financial liabilities	20,858	0	20,858	0	20,858
Total	733,201	466	732,735	335	732,400
Dec 31, 2017					
Financial assets					
Derivative financial instruments (b)	2,525	0	2,525	811	1,714
Trade and other receivables (a)	153,237	491	152,746	0	152,746
Other financial assets	1,001	0	1,001	0	1,001
Cash and cash equivalents	155,323	0	155,323	0	155,323
Total	312,086	491	311,595	811	310,784
Financial liabilities					
Borrowings	488,247	0	488,247	0	488,247
Derivative financial instruments (b)	1,419	0	1,419	811	608
Trade and other payables (a)	146,240	491	145,749	0	145,749
Other financial liabilities	10,531	0	10,531	0	10,531
Total	646,437	491	645,946	811	645,135

106 Consolidated
Statement of
Comprehensive
Income107 Consolidated
Statement of
Financial Position108 Consolidated
Statement of
Cash Flows109 Consolidated
Statement of
Changes in Equity**110 Notes to the
Consolidated Financial
Statements**197 Appendix to the Notes
to the Consolidated
Financial Statements200 Responsibility
Statement201 Independent
Auditor's Report**(a) Offsetting arrangements**

NORMA Group gives volume-based rebates to selected customers. Under the terms of the supply agreements, the amounts payable by NORMA Group are offset against receivables from the customers and only the net amounts are settled. The relevant amounts have therefore been presented net in the balance sheet.

(b) Master netting arrangements – not currently enforceable

Agreements with derivative counterparties are based on an ISDA Master Agreement and other corresponding national master agreements, such as the corresponding German Framework Agreement. These arrangements do not meet the offsetting criteria because they allow netting only in the case of future events such as default or insolvency on the part of the Group or the counterparty. The table above shows the impact on the Group's balance sheet if all set-off rights were exercised.

CURRENT AND DEFERRED INCOME TAX

The tax expenses for the period are comprised of current and deferred tax. Tax is recognized in profit or loss, except to the extent that it relates to items recognized in other comprehensive income or directly in equity. In this case, the tax is also recognized in other comprehensive income or directly in equity, respectively.

The current income tax charge is calculated on the basis of the tax laws enacted on the balance sheet date in the countries where the Group's subsidiaries operate. Management periodically evaluates positions taken in tax returns with respect to situations in which applicable tax regulation is subject to interpretation. It establishes provisions where appropriate on the basis of amounts expected to be paid to the tax authorities.

Deferred income tax is recognized using the liability method on temporary differences arising between the tax bases of assets and liabilities and their carrying amounts in the Consolidated Financial Statements and on tax losses carried forward and not yet used tax credits. Deferred income tax is determined using tax rates (and laws) that have been enacted or substantially enacted by the balance sheet date and are expected to apply when the related deferred income tax asset is realized or the deferred income tax liability is settled.

Deferred income tax assets and liabilities are offset when there is a legally enforceable right to offset current tax assets against current tax liabilities and when the deferred income tax assets and liabilities relate to income taxes levied by the same taxation authority on either the taxable entity or different taxable entities where there is an intention to settle the balances on a net basis.

A surplus of deferred income tax assets is recognized only to the extent that it is probable that future taxable profit will be available against which the temporary differences can be utilized.

For taxable temporary differences arising on investments in subsidiaries and associates, deferred tax liabilities are recognized, except where the timing of the reversal of the temporary difference is controlled by the Group and it is probable that the temporary difference will not reverse in the foreseeable future.

EMPLOYEE BENEFITS**(a) Pension obligations**

Group companies operate different pension schemes. NORMA Group has both defined benefit and defined contribution plans. A defined contribution plan is a pension plan under which the Group pays fixed contributions to a separate entity. The Group has no legal or constructive obligations to pay further contributions if the fund does not hold sufficient assets to pay all employees the benefits relating to employee service in the current and prior periods. A defined benefit plan is a pension plan that is not a defined contribution plan. The major defined benefit plan is the German benefit plan which defines the amount of pension benefit that an employee will receive on retirement to depend on years of service and compensation.

The liability recognized in the Consolidated Statement of Financial Position with respect to defined benefit pension plans is the present value of the defined benefit obligation on the balance sheet date less the fair value of plan assets. The defined benefit obligation is calculated annually by independent actuaries using the projected unit credit method. The present value of the defined benefit obligation is determined by discounting the estimated future cash outflows using interest rates of high-quality corporate bonds that are denominated in the currency in which the benefits will be paid and that have terms to maturity approximating the terms of the related pension liability.

Remeasurement gains and losses arising from experience adjustments and changes in actuarial assumptions, as well as returns on plan assets, which are not included within the net interest on the defined benefit liability, are recognized within retained earnings in other comprehensive income (OCI).

Past service costs are recognized fully in the period of the related plan amendment.

For defined contribution plans, the Group pays contributions to publicly or privately administered pension insurance plans on a mandatory, contractual or voluntary basis. The Group has no further payment obligations once the contri-

106 Consolidated Statement of Comprehensive Income

107 Consolidated Statement of Financial Position

108 Consolidated Statement of Cash Flows

109 Consolidated Statement of Changes in Equity

110 Notes to the Consolidated Financial Statements

197 Appendix to the Notes to the Consolidated Financial Statements

200 Responsibility Statement

201 Independent Auditor's Report

Contributions have been paid. The contributions are recognized as employee benefits expense when they are due. Prepaid contributions are recognized as an asset to the extent that a cash refund or a reduction in the future payments is available.

(b) Termination benefits

Termination benefits are payable when employment is terminated by the Group before the normal retirement date, or whenever an employee accepts voluntary redundancy in exchange for these benefits. The Group recognizes termination benefits as a liability and expense on the earlier date of: (a) when the entity can no longer withdraw the offer of those benefits; or (b) when the entity recognizes costs for a restructuring that is within the scope of IAS 37 and involves the payment of termination benefits. Benefits falling due more than 12 months after the balance sheet date are discounted to their present value.

(c) Short-term employee benefits

Employee benefits with short-term payment dates include wages and salaries, social security contributions, vacation pay and sickness benefits and are recognized as liabilities at the repayment amount as soon as the associated job has been performed.

(d) Provisions for other long-term employee benefits

Provisions for obligations similar to pensions (such as anniversary allowances and death benefits) are comprised of the present value of future payment obligations to the employee less any associated assets measured at fair value. The amount of provisions is determined on the basis of actuarial opinions in line with IAS 19. Gains and losses from the remeasurement are recognized in profit or loss in the period in which they are incurred.

SHARE-BASED PAYMENT

Share-based payment plans issued at NORMA Group are accounted for in accordance with IFRS 2 'Share-based Payment.' In accordance with IFRS 2, NORMA Group in principle distinguishes between equity-settled and cash-settled plans. The financial interest from equity-settled plans granted on the grant date is generally allocated over the expected vesting period against equity until the exit event occurs. Expenses from cash-settled plans are generally also allocated over the expected vesting period until the exit event occurs, but against accruals. A description of the plans existing within NORMA Group can be found in ► **NOTE 24 'SHARE-BASED PAYMENTS.'**

PROVISIONS

Provisions are recognized when the Group has a present legal or constructive obligation to third parties as a result of past events; it is probable that an outflow of resources will be required to settle the obligation; and the amount has been reliably estimated.

Where there are a number of similar obligations, the likelihood that an outflow will be required in settlement is determined by considering the class of obligations as a whole. A provision is recognized even if the likelihood of an outflow with respect to any one item included in the same class of obligations may be small.

Provisions are measured at the present value of the expenditures expected to be required to settle the obligation taking into account all identifiable risks. Provisions are discounted using a pre-tax rate that reflects current market assessments of the time value of money and the risks specific to the obligation. The increase in the provision due to passage of time is recognized as interest expense.

In addition to the expected amount of cash outflows, uncertainties also exist regarding the time of outflows. If it is expected that the outflows will take place within one year, the relevant amounts are reported in the short-term provisions.

When the Group expects a refund for a provision, this refund is recognized in accordance with IAS 37.53 as a separate asset. If the refund is in a close economic relationship with the recognized provision, the expenses from the provision are netted with the income from the corresponding refund in profit or loss.

Income from the release of non-utilized provisions from prior years is recorded within other operating income.

106	Consolidated Statement of Comprehensive Income
107	Consolidated Statement of Financial Position
108	Consolidated Statement of Cash Flows
109	Consolidated Statement of Changes in Equity
110	Notes to the Consolidated Financial Statements
197	Appendix to the Notes to the Consolidated Financial Statements
200	Responsibility Statement
201	Independent Auditor's Report

REVENUES FROM CONTRACTS WITH CUSTOMERS (REVENUE RECOGNITION)

NORMA Group recognizes revenue, when or as control over distinct goods or services is transferred to the customer; i. e. when the customer is able to direct the use of the transferred goods or services and obtains substantially all of the remaining benefits, provided a contract with enforceable rights and obligations exists and amongst others collectability of consideration is probable taking into account our customer's creditworthiness. Revenue is the transaction price NORMA Group expects to be entitled to. Variable consideration is included in the transaction price if it is highly probable that a significant reversal of revenue will not occur once associated uncertainties are resolved. The amount of variable consideration is calculated by either using the expected value or the most likely amount depending on which is expected to better predict the amount of variable consideration. Consideration is adjusted for the time value of money if the period between the transfer of goods or services and the receipt of payment exceeds twelve months and there is a significant financing benefit either to the customer or NORMA Group. If a contract contains more than one distinct good or service, the transaction price is allocated to each performance obligation based on relative stand-alone selling prices. If stand-alone selling prices are not observable, the Company reasonably estimates those. Revenue is recognized for each performance obligation either at a point in time or over time.

(a) Sale of goods

Revenues are recognized at a point in time when control of the goods passes to the buyer, usually upon delivery of the goods. Invoices are issued at that point in time and are usually payable within 30 to 90 days. For the sale of goods, retrospective volume discounts, which usually apply to a calendar year, are often agreed to. Revenues from these sales are recognized at the amount of the consideration set in the contract less the estimated volume discounts. The estimate of the refund liabilities recognized for these volume rebates is based on experience and revenue recognized in the fiscal year.

(b) Engineering services

Revenues are recognized over time under the percentage-of-completion method, based on the percentage of costs incurred to date compared to total estimated costs. An expected loss on the contract is recognized as an expense immediately. Payment terms are usually 30 to 90 days from the date of invoice issued according to the contractual terms.

The percentage of completion method places considerable importance on accurate estimates of the extent of progress towards completion and may involve estimates on the scope of deliveries and services required for fulfilling the contractually defined obligations. These estimates include total contract costs, total contract revenues, contract risks, including technical risks and other judgments. Under the percentage of completion method, changes in estimates may lead to an increase or decrease in revenue. The creditworthiness of our customers is taken into account in estimating the probability that economic benefits associated with a contract will flow to the Company.

CONTRACT ASSETS, CONTRACT LIABILITIES, REFUND LIABILITIES AND CONSIDERATIONS PAYABLE TO A CUSTOMER

When either party to a contract with customers has performed, NORMA Group presents a contract asset, a contract liability or a trade receivable depending on the relationship between NORMA's performance and the customer's payment.

106 Consolidated Statement of Comprehensive Income

107 Consolidated Statement of Financial Position

108 Consolidated Statement of Cash Flows

109 Consolidated Statement of Changes in Equity

110 Notes to the Consolidated Financial Statements

197 Appendix to the Notes to the Consolidated Financial Statements

200 Responsibility Statement

201 Independent Auditor's Report

A contract asset represents NORMA Group's right to consideration in exchange for goods or services that have been transferred to the customer. The impairment of contract assets is measured, presented and reported on the same basis as for financial assets within the scope of IFRS 9.

Trade receivables are recognized if NORMA Group's right to consideration are unconditional.

Considerations received, which are expected to be reimbursed to the customer, are shown as refund liabilities. These liabilities are included in the balance sheet in the item 'Trade and other payables.' These amounts typically relate to expected volume discounts and annual customer bonuses.

Consideration payable to a customer that cannot be directly allocated to a service or good received by NORMA Group are recognized as a reduction of the transaction price. If this reduction relates to future revenue, this part is recognized in other non-financial assets as consideration payable to a customer.

LEASES

Leases in which a significant portion of the risks and rewards of ownership are retained by the lessor are classified as operating leases. Payments made under operating leases (net of any incentives received from the lessor) are charged to profit or loss on a straight-line basis over the period of the lease.

Leases where the Group has substantially all the risks and rewards of ownership are classified as finance leases. Finance leases are capitalized at the lease's commencement at the lesser of the fair value of the leased property and the present value of the minimum lease payments.

Each lease payment is allocated between the liability and finance charges so as to achieve a constant periodic rate of interest on the finance balance outstanding. The corresponding rental obligations, net of finance charges, are included in other financial liabilities. The interest element of the finance cost is charged to profit or loss over the lease period. The property, plant and equipment acquired under finance leases is depreciated over the shorter of the useful life of the asset and the lease term.

The Group's leases include both operating leases and finance leases, which relate mainly to property and equipment.

GOVERNMENT GRANTS

Government grants are not recognized until there is reasonable assurance that the conditions attached to them are complied with and that the grants will be received.

Government grants for the compensation of expenses incurred are recognized in profit or loss as part of the other operating income on a systematic basis over the periods in which the related costs are expensed that the grants are intended to compensate for.

Grants related to non-depreciable assets are recognized in profit or loss as part of the other operating income over the periods that bear the cost of meeting the obligations.

Grants related to depreciable assets are recognized in profit or loss over the periods that bear the expense related to the depreciation of the underlying assets and are recognized as deferred income in the Statement of Financial Position. The deferred income is recognized in profit or loss on a straight-line basis over the expected useful life of the underlying asset and reported as part of other operating income.

4. SCOPE OF CONSOLIDATION

With NORMA Group SE, the Consolidated Financial Statements contain all domestic and foreign companies which NORMA Group SE controls directly or indirectly.

The Consolidated Financial Statements for 2018 include 8 domestic (Dec 31, 2017: 7) and 44 foreign (Dec 31, 2017: 41) companies.

The composition of the Group changed as follows:

T 051 CHANGE IN SCOPE OF CONSOLIDATION

	2018			2017		
	Total	Domestic	Foreign	Total	Domestic	Foreign
As of January 1	48	7	41	47	7	40
Additions	5	1	4	2	0	2
of which newly founded	2	0	2	0	0	0
of which acquired	3	1	2	2	0	2
Disposals	1	0	1	1	0	1
of which newly founded	1	0	1	0	0	0
of which mergers	0	0	0	1	0	1
As of December 31	52	8	44	48	7	41

In the second quarter of 2018, NORMA Group acquired Kimplas Piping Systems Ltd. and Kimplas Ltd. ('Kimplas') based in Nashik, Maharashtra, India and Essex, Great Britain, and STATEK Stanzereitechnik GmbH ('Statek') based in Maintal, Germany.

Furthermore, the entities NG AM FinSrv, LLC and NORMA Manufacturing NA SW, LLC, both based in Auburn Hills, USA were founded in 2018.

Besides this, Guyco Pty. Ltd. was liquidated and deconsolidated in the fiscal year.

For further details, please refer to ► **NOTE 32 'BUSINESS COMBINATIONS.'**

106 Consolidated Statement of Comprehensive Income

107 Consolidated Statement of Financial Position

108 Consolidated Statement of Cash Flows

109 Consolidated Statement of Changes in Equity

110 Notes to the Consolidated Financial Statements

197 Appendix to the Notes to the Consolidated Financial Statements

200 Responsibility Statement

201 Independent Auditor's Report



For a detailed overview of NORMA Group's shareholdings, please refer to the following chart:

T052 LIST OF GROUP COMPANIES OF NORMA GROUP AS OF DECEMBER 31, 2018

No.	Company	Registered address	held by	Share in %		Currency	Equity ¹	Result ²
				parent company	of NORMA Group SE			
Central functions								
01	NORMA Group SE	Maintal, Germany						
02	NORMA Group APAC Holding GmbH	Maintal, Germany	01	100.00	100.00	kEUR	32	-3
03	NORMA Group Holding GmbH	Maintal, Germany	01	100.00	100.00	kEUR	106,814	0 ²
Segment EMEA								
04	NORMA Distribution Center GmbH	Marsberg, Germany	03	94.80	100.00	kEUR	2,175	0 ²
05	DNL GmbH & Co KG	Maintal, Germany	03	100.00	100.00	kEUR	6,312	-81
06	NORMA Germany GmbH	Maintal, Germany	03	94.90	100.00	kEUR	56,306	0 ²
07	NORMA Verwaltungs GmbH (formerly NORMATürkei Verwaltungs GmbH)	Maintal, Germany	03	100.00	100.00	kEUR	20	0 ²
08	STATEK Stanzerei Technik GmbH	Maintal, Germany	03	100.00	100.00	kEUR	4,326	666
09	DNL France SAS	Briey, France	03	100.00	100.00	kEUR	34,200	-4,400
10	NORMA Autoline France SAS	Guichen, France	09	100.00	100.00	kEUR	26,328	700
11	NORMA Distribution France SAS	Croissy Beaubourg, France	09	100.00	100.00	kEUR	2,948	811
12	NORMA France SAS	Briey, France	09	100.00	100.00	kEUR	6,089	3,056
13	DNL UK Ltd.	Newbury, Great Britain	03	100.00	100.00	kGBP	15,958	20,954
14	NORMA UK Ltd.	Newbury, Great Britain	13	100.00	100.00	kGBP	17,744	8,197
15	NORMA Italia SpA	Gavardo, Italy	03	100.00	100.00	kEUR	6,357	2,213
16	Groen Bevestigingsmaterialen B.V.	Purmerend, Netherlands	03	70.00	100.00	kEUR	1,665	1,659
17	NORMA Netherlands B.V.	Purmerend, Netherlands	22	100.00	100.00	kEUR	811	416
18	NORMA Polska Sp. z o.o.	Slawniów, Poland	03	100.00	100.00	kPLN	149,366	21,715
19	NORMA Group Distribution Polska Sp. z o.o.	Slawniów, Poland	18	100.00	100.00	kPLN	10,697	3,053
20	Lifial – Indústria Metalúrgica de Águeda, Lda.	Águeda, Portugal	03	99.99	100.00	kEUR	5,628	113
21	NORMA Group CIS LLC	Togliatti, Russian Federation	03	99.96	100.00	kRUB	206,447	59,808
22	DNL Sweden AB	Stockholm, Sweden	03	100.00	100.00	kSEK	89,156	85,399
23	NORMA Sweden AB	Stockholm, Sweden	22	100.00	100.00	kSEK	212,756	71,218
24	Connectors Verbindungstechnik AG	Tagelswangen, Switzerland	03	100.00	100.00	kCHF	4,332	-179
25	NORMA Grupa Jugoistocna Evropa d.o.o.	Subotica, Serbia	03	100.00	100.00	kRSD	4,448,754	-43,619
26	Fijaciones NORMA S.A.U.	L'Hospitalet de Llobregat, Spain	03	100.00	100.00	kEUR	5,385	1,005
27	NORMA Czech, s.r.o.	Hustopecce, Czech Republic	03	100.00	100.00	kCZK	338,949	12,701
28	NORMA Turkey Bağlantı ve Birleştirme Teknolojileri Sanayi ve Ticaret Limited Şirketi	Kartal-Istanbul, Turkey	07	100.00	100.00	kTRL	7,592	3,838

continued on next page ►

106 Consolidated Statement of Comprehensive Income

107 Consolidated Statement of Financial Position

108 Consolidated Statement of Cash Flows

109 Consolidated Statement of Changes in Equity

110 Notes to the Consolidated Financial Statements

197 Appendix to the Notes to the Consolidated Financial Statements

200 Responsibility Statement

201 Independent Auditor's Report

106 Consolidated
Statement of
Comprehensive
Income107 Consolidated
Statement of
Financial Position108 Consolidated
Statement of
Cash Flows109 Consolidated
Statement of
Changes in Equity**110 Notes to the
Consolidated Financial
Statements**197 Appendix to the Notes
to the Consolidated
Financial Statements200 Responsibility
Statement201 Independent
Auditor's Report**T052 LIST OF GROUP COMPANIES OF NORMA GROUP AS OF DECEMBER 31, 2018 (CONTINUED)**

No.	Company	Registered address	held by	Share in %		Currency	Equity ¹	Result ²
				Direct parent company	of NORMA Group SE			
Segment Americas								
29	NORMA do Brasil Sistemas De Conexão Ltda.	Atibaia, Brazil	37	98.20	100.00	kUSD	12,722	-9,938
30	NORMA Group México S. de R.L. de C.V. ³	Monterrey, Mexico	36	99.40	100.00	kUSD	4,488	-4,284
31	NORMA Distribution and Services S. de R.L. de C.V.	Juarez, Mexico	36	99.00	100.00	kUSD	-4,888	-1,447
32	Craig Assembly Inc.	Auburn Hills, MI, USA	37	100.00	100.00	kUSD	64,527	14,668
33	National Diversified Sales, Inc.	Woodland Hills, CA, USA	37	100.00	100.00	kUSD	283,749	30,771
34	NG AM FINSRV I, LLC	Auburn Hills, MI, USA	36	70.00	100.00	kUSD	-262	-262
35	NORMA MANUFACTURING NA SW, LLC	Auburn Hills, MI, USA	36	100.00	100.00	kUSD	2	2
36	NORMA Michigan Inc.	Auburn Hills, MI, USA	37	100.00	100.00	kUSD	93,550	7,370
37	NORMA Pennsylvania Inc.	Auburn Hills, MI, USA	01	100.00	100.00	kBRL	112,736	-1,769
38	NORMA US Holding LLC	Auburn Hills, MI, USA	37	100.00	100.00	kUSD	22,739	-980
39	R.G. RAY Corporation	Auburn Hills, MI, USA	37	100.00	100.00	kMXN	120,500	11,080
Segment Asia-Pacific								
40	NORMA Pacific Pty. Ltd.	Adelaide South Croydon, Vic., Australia	51	100.00	100.00	kAUD	15,625	-5,336
41	Fengfan Fastener (Shaoxing) Co., Ltd.	Shaoxing City, China	51	80.00	80.00	kCNY	33,060	4,215
42	NORMA China Co., Ltd.	Qingdao, China	03	100.00	100.00	kCNY	219,951	31,889
43	NORMA EJT (Changzhou) Co., Ltd.	Changzhou, China	51	100.00	100.00	kCNY	66,254	18,993
44	NORMA EJT (Wuxi) Co., Ltd.	Wuxi, China	51	100.00	100.00	kCNY	208,984	75
45	NORMA Group Products India Pvt. Ltd.	Pune, India	51	99.99	100.00	kINR	532,304	112,532
46	Kimplas Piping Systems Ltd.	Nashik, Maharashtra, India	51	100.00	100.00	kINR	1,822,961	75,667
47	Kimplas Limited	Essex, Great Britain	46	100.00	100.00	kGBP	490	59
48	NORMA Japan Inc.	Tokyo, Japan	51	60.00	60.00	kJPY	135,613	13,143
49	NORMA Products Malaysia Sdn. Bhd. (formerly Chien Jin Plastic Sdn. Bhd.)	Ipoh, Malaysia	51	100.00	100.00	kMYR	31,089	-2,054
50	NORMA Korea Inc.	Seoul, Republic of Korea	51	100.00	100.00	kKRW	831,373	334,344
51	NORMA Group Asia Pacific Holding Pte. Ltd.	Singapore, Singapore	01	100.00	100.00	kSGD	235,526	-2,950
52	NORMA Pacific (Thailand) Ltd.	Chonburi, Thailand	51	99.99	100.00	kTHB	102,980	17,451

1_Reported values according to IFRS as of December 31, 2018; except for NORMA Group Holding GmbH, NORMA Germany GmbH and NORMA Distribution Center GmbH; these values are prepared according to German GAAP as of December 31, 2018, but not yet finally audited. The values are translated with the exchange rates according to ► NOTE 3.

2_A profit pooling contract exists.

3_Maquiladora operation of company No. 36.



106 Consolidated Statement of Comprehensive Income
 107 Consolidated Statement of Financial Position
 108 Consolidated Statement of Cash Flows
 109 Consolidated Statement of Changes in Equity
110 Notes to the Consolidated Financial Statements
 197 Appendix to the Notes to the Consolidated Financial Statements
 200 Responsibility Statement
 201 Independent Auditor's Report

5. FINANCIAL RISK MANAGEMENT

FINANCIAL RISK FACTORS

The Group's operations expose it to a variety of financial risks, including market, credit and liquidity risks. The Group's financial risk management focuses on the unpredictability of the financial markets and is designed to mitigate potential adverse effects on the Group's financial performance. The Group uses derivative financial instruments to hedge certain exposures.

T053 OVERVIEW OF FINANCIAL RISKS

Risk	Risks from	Assessment	Management
Market risk – Foreign exchange risk	Future transactions and recognized financial assets and liabilities	Cash flow projections and sensitivity analysis	Forward exchange contracts and natural hedges
Market risk – Interest rate risk	Long-term borrowings at variable interest rates	Sensitivity analysis	Interest rate swaps
Default risk	Cash and cash equivalents, derivative financial instruments, trade receivables and contractual assets	Age structure analysis and credit rating	Diversification of bank balances, credit limits and letters of credit
Liquidity risk	Payment obligations arising from borrowings and other liabilities	Rolling cash flow forecasts	Availability of committed credit lines and facilities and trade working capital management

Financial risk management is carried out by a central Treasury department (Group Treasury). The responsibilities and necessary controls related to risk management are defined by the Group's management. The Treasury department is responsible for identifying, assessing and hedging financial risks in close consultation with the Group's operating units. The use of derivative and non-derivative financial instruments and the investment of liquidity surpluses are governed by policies established by Group management.

(a) Market risk

Foreign exchange risk

NORMA Group operates as an internationally active Company in 100 different countries and is exposed to the currency risk resulting from various foreign currency positions in respect of the most important currencies: US dollars, British pounds, Chinese renminbi, Indian rupees, Polish rupees, Zloty, Swedish krona, Swiss francs, Czech koruna, Serbian dinar and Singapore dollars.

The Group's treasury risk management policy aims to hedge 50% - 90% of the expected cash flows from operating activities of the significant foreign currency exposures.

The external financial liabilities denominated in US dollars are repaid with US dollar receipts resulting from the externally financed investments in the US. The foreign currency position of these liabilities was therefore not hedged.

The Group uses forward exchange contracts to hedge the foreign exchange risk arising from its operating activities. The risk arises from a possible change in future cash flows from a highly probable forecast transaction in a non-functional currency, which is due to a change or fluctuation in the exchange rate. The hedging relationship is designated as a cash flow hedge. The Group only designates the spot component as a hedging element. Gains or losses on the effective portion of the change in the spot component of the forward contract are recognized in the hedging reserve as a component of equity. Changes in the forward component of the hedging instrument relating to the hedged item ("aligned forward element") are recognized in other comprehensive income in the hedging reserve as a component of equity.

In addition, the Group uses forward exchange contracts to hedge intercompany financing transactions that involve foreign exchange risk arising from intercompany loans denominated in non-functional currencies. The Group designates such loans and hedging instruments as fair value hedges in order to achieve the offsetting effects of hedged items and hedges in the same income statement line item. The Group designates only the spot component as a hedging element. Gains or losses from the effective portion of the change in the spot component of the forward transaction are recognized in the financial result, analogous to those of the underlying item. The changes in the forward component of the hedging instrument, which relate to the hedged underlying transaction ("aligned forward element") are also included in this item.

For more information on the foreign currency risk hedging instruments used by the Group, please refer to ► **NOTE 20. (F) 'DERIVATIVE FINANCIAL INSTRUMENTS.'**

106	Consolidated Statement of Comprehensive Income
107	Consolidated Statement of Financial Position
108	Consolidated Statement of Cash Flows
109	Consolidated Statement of Changes in Equity
110	Notes to the Consolidated Financial Statements
197	Appendix to the Notes to the Consolidated Financial Statements
200	Responsibility Statement
201	Independent Auditor's Report

In accordance with the Group guideline, the essential contractual conditions of the forward transactions for all hedging relationships must correspond to the hedged underlying transactions.

The effects of changes in the exchange rates of financial assets and financial liabilities denominated in foreign currencies are presented below.

T 054 FOREIGN EXCHANGE RISK

IN EUR THOUSANDS	Dec 31, 2018		Dec 31, 2017	
	+10%	-10%	+10%	-10%
Currency relation				
EUR/USD				
Profit before tax	-681	833	-781	955
EUR/GBP				
Profit before tax	308	-376	511	-624
EUR/CNY				
Profit before tax	-567	693	-814	995
EUR/INR				
Profit before tax	-208	255	-226	277
EUR/PLN				
Profit before tax	727	-888	768	-939
EUR/SEK				
Profit before tax	256	-313	619	-756
EUR/CHF				
Profit before tax	123	-151	212	-260
EUR/CZK				
Profit before tax	233	-285	263	-321
EUR/RSD				
Profit before tax	-91	111	479	-585
EUR/SGD				
Profit before tax	-465	568	-370	452

Interest rate risk

NORMA Group's interest rate risk arises from long-term borrowings with variable interest rates. Borrowings issued at variable interest rates expose the Group to cash flow interest rate risk which is partially offset by hedges (interest rate swaps). The Group's policy is to maintain approximately 75% of its medium-term borrowings in fixed rate instruments. NORMA Group uses the flexibility of floating instruments for extraordinary repayments without any additional cost.

Currently existing swaps cover around 71% (2017: 92%) of outstanding variable interest rate loans. Further information on the instruments used to hedge the interest rate risk used by the Group can be found under ► **NOTE 20. (F) 'DERIVATIVE FINANCIAL INSTRUMENTS.'**

Below, the effects of changes in interest rates are analyzed for bank borrowings which bear variable interest rates, and for interest rate swaps included in hedge accounting. Borrowings that bear fixed interest rates are excluded from this analysis.

Due to the current low level of interest rates in those markets that are relevant for NORMA Group's funding, the likelihood of rising interest rates is higher than that of declining interest rates – this has been addressed in the sensitivity analysis.

In fiscal year 2018, if interest rates on euro and US dollar denominated borrowings had been 100 basis points (BPS) (2017: 100 BPS) higher with all other variables held constant, profit before tax for the year would have been EUR 503 thousand lower (2017: EUR 436 thousand lower) and other comprehensive income would have been EUR 2,716 thousand higher (2017: EUR 4,030 thousand higher with a 100 basis points shift).

In fiscal year 2018, if interest rates on euro and US dollar denominated borrowings had been 50 basis points (2017: 50 BPS) lower with all other variables held constant, profit before tax for the year would have been EUR 63 thousand higher (2017: EUR 105 thousand higher). Other comprehensive income would have been EUR 1,437 thousand lower (2017: EUR 2,181 thousand lower).

106 Consolidated
Statement of
Comprehensive
Income107 Consolidated
Statement of
Financial Position108 Consolidated
Statement of
Cash Flows109 Consolidated
Statement of
Changes in Equity**110 Notes to the
Consolidated Financial
Statements**197 Appendix to the Notes
to the Consolidated
Financial Statements200 Responsibility
Statement201 Independent
Auditor's Report**Other price risks**

As NORMA Group is not exposed to any other material economic price risks, such as stock exchange prices or commodity prices, an increase or decrease in the relevant market prices within reasonable margins would not have an impact on the Group's profit or equity. Hence, the Group's exposure to other price risks is regarded as not material. ► **RISK AND OPPORTUNITY REPORT, P. 79**

(b) Credit risk

The credit risk incurred by the Group is the risk that counterparties fail to meet their obligations arising from operating activities and from financial transactions. Credit risk arises from cash and cash equivalents and deposits with banks and financial institutions, as well as credit exposures to customers, including outstanding receivables and committed transactions.

Credit risk is monitored on a Group basis. To minimize credit risk from operating activities and financial transactions, each counterparty is assigned a credit limit, the use of which is monitored regularly. Default risks are continuously monitored in the operating business.

In order to reduce the credit risk arising from our investing activities and derivative financial assets, in accordance with our internal treasury policy, we have entered into all transactions only with recognized, large financial institutions and issuers, each with high external credit ratings.

In operational business, default risks are continuously monitored.

The aggregate carrying amounts of financial assets represent the maximum default risk. Given the Group's heterogeneous customer structure, there is no risk concentration.

As of December 31, 2018, the credit exposure for the gross carrying amounts of cash and cash equivalents and other financial assets was as follows:

T 055 CREDIT RISK EXPOSURE FROM CAHS AND CASH EQUIVALENTS AND OTHER FINANCIAL ASSETS**As of December 31, 2018**

IN EUR THOUSANDS	Equivalent to External Rating	Gross Carrying Amount Not Credit- Impaired	Gross Carrying Amount Credit-Impaired
Risk class 1 – low risk	AAA – BBB-	202,990	0

Further details on the credit risk positions for trade receivables can be found under ► **NOTES 20 (A) 'TRADE AND OTHER RECEIVABLES.'**

(c) Liquidity risk

Prudent liquidity risk management implies maintaining sufficient cash and marketable securities, the availability of funding through an adequate amount of committed credit facilities and the ability to close out market positions. Due to the dynamic nature of the underlying businesses, Group Treasury maintains flexibility in funding by maintaining availability under committed credit lines.

Following the initial public offering of NORMA Group in April 2011, syndicated financing of EUR 250 million was concluded, of which EUR 178 million was repaid by December 2014. In September 2014, the existing syndicated financing with a volume of EUR 100 million was renegotiated. In December 2015, the syndicated credit line was again adjusted to a total of EUR 100 million in euros and US dollars in order to further minimize interest costs and take account of NORMA Group's changed currency cash flows (mainly euros and US dollars) resulting from the acquisition of NDS. In June 2018, NORMA Group drew on EUR 102 million from the accordion facility available in the syndicated loan to refinance a promissory note tranche from 2013 due and for M&A financing. Following scheduled repayments in 2016, 2017 and 2018, the credit volume on December 31, 2018, was EUR 119 million and \$ 74.7 million respectively (value in euros on Dec. 31, 2018: EUR 65.3 million). In addition to the syndicated loan, NORMA Group has an option on an additional EUR 148 million in the form of the remaining accordion facility with a term until 2022. Furthermore, a revolving credit line in the amount of EUR 50 million over the same term can be drawn on for future business activities and to meet capital commitments, which were not utilized as of December 31, 2018.

In July 2013, NORMA Group also issued a promissory note loan of EUR 125 million with 5, 7 and 10 year maturities. The two variable 5- and 7-year tranches of the 2013 promissory note loan totaling EUR 49 million were repaid early in July



2016. For this purpose, the revolving credit line from the syndicated loan of EUR 40 million was drawn down at short notice. To refinance this line and for M&A financing, another promissory note loan with euro tranches of EUR 102 million with maturities of 5, 7 and 10 years and US dollar tranches of USD 52.5 million with maturities of 5 and 7 years was issued in August 2016. After scheduled repayment in 2018, the loan volume of the 2013 promissory note loan amounts to EUR 50 million as of December 31, 2018.

In the fourth quarter of 2014, an additional promissory note loan was issued with euro tranches of EUR 106 million with 3, 5, 7 and 10 year maturities and US dollar tranches of \$ 128.5 million with 3, 5 and 7 year maturities. Following scheduled repayment in 2017, the credit volume of the 2014 promissory note loan amounted to EUR 91.5 million and \$ 107.5 million as of December 31, 2018 (value in euros as of Dec. 31, 2018: EUR 93.9 million).

Liquidity is monitored on an ongoing basis with regard to the Group's business performance, planned investment and redemption of capital.

The amounts disclosed in the table below are the contractual, undiscounted cash flows. Financial liabilities denominated in foreign currencies are translated at the closing rate on the balance sheet date. Interest payments on financial instruments with variable interest rates are calculated on the basis of the interest rates applicable as of the reporting date.

T 056 MATURITY STRUCTURE OF NON-DERIVATIVE FINANCIAL LIABILITIES

Dec 31, 2018	up to 1 year	> 1 year up to 2 years	> 2 years up to 5 years	> 5 years
IN EUR THOUSANDS				
Borrowings	127,305	44,624	355,739	90,115
Trade and other payables	142,028			
Finance lease liabilities	17	5	13	
Other financial liabilities	18,850	0	1,976	
	288,200	44,629	357,728	90,115
Dec 31, 2017		> 1 year up to 2 years	> 2 years up to 5 years	> 5 years
IN EUR THOUSANDS				
Borrowings	44,636	117,961	218,144	155,745
Trade and other payables	145,749			
Finance lease liabilities	123	32	2	
Other financial liabilities	6,183	245	3,946	
	196,691	118,238	222,092	155,745

The maturity structure of the derivative financial instruments based on cash flows is as follows:

T 057 MATURITY STRUCTURE OF DERIVATIVE FINANCIAL INSTRUMENTS

As of Dec 31, 2018	up to 1 year	> 1 year up to 2 years	> 2 years up to 5 years	> 5 years
IN EUR THOUSANDS				
Derivative receivables – gross settlement				
Cash outflows	-31,221			
Cash inflows	31,414			
Derivative liabilities – gross settlement				
Cash outflows	-5,385			
Cash inflows	5,302			
Derivative receivables – net settlement				
Cash inflows	1,746	608	217	
Derivative liabilities – net settlement				
Cash outflows	-216	-418	-41	
	1,640	190	176	0

As of Dec 31, 2017	up to 1 year	> 1 year up to 2 years	> 2 years up to 5 years	> 5 years
IN EUR THOUSANDS				
Derivative receivables – gross settlement				
Cash outflows	-46,208			
Cash inflows	46,848			
Derivative liabilities – gross settlement				
Cash outflows	-11,352			
Cash inflows	11,159			
Derivative receivables – net settlement				
Cash inflows	654	431	800	
Derivative liabilities – net settlement				
Cash outflows	-418	-384	-424	
	683	47	376	0

106	Consolidated Statement of Comprehensive Income
107	Consolidated Statement of Financial Position
108	Consolidated Statement of Cash Flows
109	Consolidated Statement of Changes in Equity
110	Notes to the Consolidated Financial Statements
197	Appendix to the Notes to the Consolidated Financial Statements
200	Responsibility Statement
201	Independent Auditor's Report

CAPITAL RISK MANAGEMENT

The Group's objectives when managing capital are to ensure that it will continue to be able to repay its debt and remain financially sound.

The Group is subject to the financial covenant total net debt cover (net debt in relation to adjusted Group EBITDA), which is monitored on an ongoing basis. This financial covenant is based on the Group's Consolidated Financial Statements as well as on special definitions of the bank facility agreements. There were no covenant breaches in 2018 and 2017.

In the case of a covenant breach, the facility agreement includes several ways to remedy a potential breach by rules of exemption or shareholder actions. If a covenant breach occurs and is not remedied, the syndicated loans may be, but are not required to be, withdrawn.

6. CRITICAL ACCOUNTING ESTIMATES AND JUDGMENTS

Estimates and judgments are continually evaluated and are based on historical experience, and expectations regarding future events that are believed to be reasonable under the circumstances.

The Group makes estimates and assumptions concerning the future. The resulting accounting estimates will, by definition, seldom equal the respective actual results. The estimates and assumptions that have a significant risk of causing a material adjustment to the carrying amounts of assets and liabilities within the next fiscal year are addressed below.

ESTIMATED IMPAIRMENT OF GOODWILL

NORMA Group tests annually whether goodwill has suffered any impairment in accordance with the accounting policy stated in ► **NOTE 3 'SUMMARY OF SIGNIFICANT ACCOUNTING PRINCIPLES – IMPAIRMENT OF NON-FINANCIAL ASSETS.'** The recoverable amounts of cash-generating units have been determined based on fair value less costs to sell calculations. These calculations are based on discounted cash flow models, which require the use of estimates. ► **NOTE 18 'GOODWILL AND OTHER INTANGIBLE ASSETS'**

In 2018 and 2017, no impairment of goodwill, which amounted to EUR 389,505 thousand on December 31, 2018 (Dec 31, 2017: EUR 356,717 thousand), was necessary. Even if the discount rate would increase by +2% and the terminal value growth rate would be 0%, the change of these key assumptions would not cause the carrying amount to exceed its recoverable amount in any CGU.

INCOME TAXES

The Group is subject to income taxes in numerous jurisdictions. Significant judgments are required in determining the worldwide provision for income taxes. There are transactions and calculations for which the ultimate tax determination is uncertain. The Group recognizes liabilities for anticipated tax audit issues based on estimates of whether additional taxes will be due. Where the final tax outcome of these matters differs from the amounts that were initially recorded, such differences will impact the current and deferred income tax assets and liabilities in the period in which such determination is made. On December 31, 2018, income tax liabilities were EUR 6,580 thousand (Dec 31, 2017: EUR 7,960 thousand) and deferred tax liabilities were EUR 73,099 thousand (Dec 31, 2017: EUR 60,543 thousand).

PENSION BENEFITS

The present value of the pension obligations depends on a number of factors determined on an actuarial basis using a number of assumptions. The assumptions used in determining the net cost (income) for pensions include the discount rate. Any changes in these assumptions will impact the carrying amount of pension obligations.

The present value of the defined benefit obligation is calculated by discounting the estimated future cash outflows using the interest rates of high-quality corporate bonds.

The Group determines the appropriate discount rate on the balance sheet date. In determining the appropriate discount rate, the Group considers the interest rates of high-quality corporate bonds that are denominated in the currency in which the benefits will be paid, and that have terms to maturity approximating the terms of the related pension liability.

Other key assumptions for pension obligations are based in part on current market conditions. Additional information is disclosed in ► **NOTE 3 'SUMMARY OF SIGNIFICANT ACCOUNTING PRINCIPLES – EMPLOYEE BENEFITS.'**

Pension liabilities amounted to EUR 12,804 thousand on December 31, 2018 (Dec 31, 2017: EUR 12,127 thousand).

106	Consolidated Statement of Comprehensive Income
107	Consolidated Statement of Financial Position
108	Consolidated Statement of Cash Flows
109	Consolidated Statement of Changes in Equity
110	Notes to the Consolidated Financial Statements
197	Appendix to the Notes to the Consolidated Financial Statements
200	Responsibility Statement
201	Independent Auditor's Report

USEFUL LIVES OF PROPERTY, PLANT AND EQUIPMENT AND INTANGIBLE ASSETS

The Group's management determines the estimated useful lives and related depreciation/amortization charges for its property, plant and equipment and intangible assets. This estimate is based on projected lifecycles. These could change as a result of technical innovations or competitor actions in response to severe industry cycles. Management will increase the depreciation charge where useful lives are less than previously estimated lives, or it will write-off or write-down technically obsolete or non-strategic assets that have been abandoned or sold.

7. ADJUSTMENTS

Certain expenses are adjusted for operational management purposes. Hence, the following results which are adjusted by these expenses, reflect the management perspective.

In fiscal year 2018, net expenses of EUR 4,390 thousand in total were adjusted within EBITDA (2017: EUR 3,494 thousand). These relate to the cost of materials in the amount of EUR 389 thousand resulting from the valuation of the acquired inventories as part of the purchase price allocation for the Kimplas acquisition. Furthermore, expenses for acquisition-related costs in connection with the acquisition of Kimplas and Statek in the amount of EUR 1,190 thousand were adjusted within other operating expenses. Moreover, expenses for the integration of the two companies of EUR 426 thousand were adjusted within other operating expenses and within employee benefits EUR 152 thousand.

In addition, adjustments were made in connection with the rightsizing project initiated in the fourth quarter of 2018 to optimize the Group's structures. The adjustments within expenses for employee benefits relate to costs for project hours of internal employees of the core workforce (EUR 1,044 thousand), costs for project employees hired temporarily (EUR 604 thousand) and costs for severance payments made (EUR 123 thousand). Furthermore, costs within other operating expenses amounting to EUR 443 thousand and costs within cost of materials amounting to EUR 19 thousand were also adjusted.

In fiscal year 2017, adjustments within EBITDA are related in the amount of EUR 1,131 thousand to expenses for raw materials and consumables used resulting from the valuation of acquired inventories within the purchase price allocation for the acquisition of the Autoline business, Lifial and Fengfan. In addition, expenses for the integration of the Autoline business in the amount of EUR 2,232 thousand were adjusted in other operating expenses and in the amount of EUR 662 thousand within employee benefits expense. Income in the amount of EUR 531 thousand resulting from the refund of a transaction tax paid in connection with the acquisition of the Autoline business was adjusted within other operating income.

Besides the adjustments mentioned, depreciation in the amount of EUR 3,993 thousand (2017: EUR 4,191 thousand) and amortization in the amount of EUR 21,124 thousand (2017: EUR 20,482 thousand) from purchase price allocations were adjusted as in previous years.

Furthermore, an impairment loss of EUR 1,433 thousand in the area of capitalized customer relationships was adjusted in fiscal year 2018 within amortization of intangible assets. This related to the Chinese company Fengfan.

The theoretical taxes resulting from the adjustments are calculated using the respective tax rate of each Group entity and are considered within the adjusted earnings after taxes.

In fiscal year 2017, an adjustment of one-time non-cash deferred tax income of EUR 33,909 thousand due to the reduction in the US corporate income tax rate was made within the income taxes.

The following table shows profit or loss net of these expenses:

T 058 PROFIT AND LOSS NET OF ADJUSTMENTS

IN EUR THOUSANDS	2018 unadjusted	M&A related costs	Integration costs	Step-up effects from purchase price allocations	"Rightsizing/ Footprint"	Total adjustments	2018 adjusted
Revenue	1,084,140					0	1,084,140
Changes in inventories of finished goods and work in progress	10,383					0	10,383
Other own work capitalized	5,197					0	5,197
Raw materials and consumables used	-473,551			389	19	408	-473,143
Gross profit	626,169	0	0	389	19	408	626,577
Other operating income and expenses	-146,427	1,190	426		443	2,059	-144,368
Employee benefits expense	-282,768		152		1,771	1,923	-280,845
EBITDA	196,974	1,190	578	389	2,233	4,390	201,364
Depreciation	-32,175			3,993		3,993	-28,182
EBITA	164,799	1,190	578	4,382	2,233	8,383	173,182
Amortization	-31,254			22,557		22,557	-8,697
Operating profit (EBIT)	133,545	1,190	578	26,939	2,233	30,940	164,485
Financial costs – net	-11,668					0	-11,668
Profit before income tax	121,877	1,190	578	26,939	2,233	30,940	152,817
Income taxes	-30,089	-305	-148	-6,903	-572	-7,928	-38,017
Profit for the period	91,788	885	430	20,036	1,661	23,012	114,800
Non-controlling interests	-85					0	-85
Profit attributable to shareholders of the parent	91,873	885	430	20,036	1,661	23,012	114,885
Earnings per share (in EUR)	2.88						3.61

continued on next page ►

INTRODUCTION

OUR VISION

TO OUR SHAREHOLDERS

CONSOLIDATED
MANAGEMENT REPORT

**CONSOLIDATED
FINANCIAL STATEMENTS**

FURTHER INFORMATION

106 Consolidated
Statement of
Comprehensive
Income

107 Consolidated
Statement of
Financial Position

108 Consolidated
Statement of
Cash Flows

109 Consolidated
Statement of
Changes in Equity

**110 Notes to the
Consolidated Financial
Statements**

197 Appendix to the Notes
to the Consolidated
Financial Statements

200 Responsibility
Statement

201 Independent
Auditor's Report

T 058 PROFIT AND LOSS NET OF ADJUSTMENTS (CONTINUED)

IN EUR THOUSANDS	2017 unadjusted	One-time effect US tax reform	Integration costs	Step-up effects from purchase price allocations	Refund transaction tax	Total adjustments	2017 adjusted
Revenue	1,017,084					0	1,017,084
Changes in inventories of finished goods and work in progress	-1,072					0	-1,072
Other own work capitalized	3,911					0	3,911
Raw materials and consumables used	-419,748			1,131		1,131	-418,617
Gross profit	600,175	0	0	1,131	0	1,131	601,306
Other operating income and expenses	-133,684		2,232		-531	1,701	-131,983
Employee benefits expense	-270,237		662			662	-269,575
EBITDA	196,254	0	2,894	1,131	-531	3,494	199,748
Depreciation	-29,421			4,191		4,191	-25,230
EBITA	166,833	0	2,894	5,322	-531	7,685	174,518
Amortization	-29,046			20,482		20,482	-8,564
Operating profit (EBIT)	137,787	0	2,894	25,804	-531	28,167	165,954
Financial costs – net	-16,055					0	-16,055
Profit before income tax	121,732	0	2,894	25,804	-531	28,167	149,899
Income taxes	-1,916	-33,909	-940	-8,318	177	-42,990	-44,906
Profit for the period	119,816	-33,909	1,954	17,486	-354	-14,823	104,993
Non-controlling interests	152					0	152
Profit attributable to shareholders of the parent	119,664	-33,909	1,954	17,486	-354	-14,823	104,841
Earnings per share (in EUR)	3.76						3.29

106 Consolidated
Statement of
Comprehensive
Income107 Consolidated
Statement of
Financial Position108 Consolidated
Statement of
Cash Flows109 Consolidated
Statement of
Changes in Equity**110 Notes to the
Consolidated Financial
Statements**197 Appendix to the Notes
to the Consolidated
Financial Statements200 Responsibility
Statement201 Independent
Auditor's Report

NOTES TO THE CONSOLIDATED STATEMENT OF COMPREHENSIVE INCOME

8. REVENUE FROM CONTRACTS WITH CUSTOMERS

Revenue recognized during the period related to the following:

T059 REVENUE BY DISTRIBUTION CHANNEL

IN EUR THOUSANDS	2018	2017
Engineered Joining Technology (EJT)	684,575	638,165
Distribution Services (DS)	393,840	372,348
Other revenue	5,725	6,571
	1,084,140	1,017,084

Revenue for 2018 (EUR 1,084,140 thousand) was 6.6% above revenue for 2017 (EUR 1,017,084 thousand). The increase in revenue resulted from organic growth and the inclusion of Kimplas and Statek, both acquired in the third quarter of 2018, and of Fengfan, acquired in the second quarter of 2017. Negative currency effects had the opposite effect. Kimplas contributed EUR 10,162 thousand and Statek contributed EUR 2,107 thousand to revenue in fiscal year 2018. Revenues from both companies are fully allocated to Distribution Services.

T060 REVENUE BY CATEGORY

IN EUR THOUSANDS	2018
Revenues from the sale of goods	1,077,338
Revenues from engineering services	425
Revenues from other services	1,204
Other revenue	5,173
	1,084,140

Other revenue mainly consists of revenue from the sale of production residues in metal production.

Revenues in 2018 include income of EUR 2,719 thousand from the reversal of reimbursement liabilities recognized in the previous period. The reversals represent the difference between the expected volume discounts and annual bonuses recognized for customers in the previous period and the actual payment in the fiscal year.

In 2017, EUR 142 thousand in revenues from construction contracts are included.

For the analysis of sales by region, please refer to ► **NOTE 29 'SEGMENT REPORTING.'**

CONTRACT ASSETS AND LIABILITIES

Contract assets represent revenues from development services rendered, which were realized based on the ratio of costs already incurred to the estimated total costs. The contract liabilities represent advance payments received for goods to be supplied by NORMA Group. Contract assets and contract liabilities in the amounts of EUR 1,185 thousand and EUR 453 thousand respectively are expected to be realized or settled within the next twelve months. The contract liabilities from advance payments received in the amount of EUR 193 thousand recognized as of January 1, 2018, were recognized as sales revenues, net of any sales taxes, in the fiscal year.

TRANSACTION PRICE OF UNSATISFIED PERFORMANCE OBLIGATIONS

NORMA Group applies the practical expedient of IFRS 15 and does not disclose the transaction price allocated to unsatisfied performance obligations as of the balance sheet date, as the outstanding obligations are part of a contract with an initial term of up to twelve months.

9. RAW MATERIALS AND CONSUMABLES USED

Raw materials and consumables used comprised the following:

T061 RAW MATERIALS AND CONSUMABLES USED

IN EUR THOUSANDS	2018	2017
Cost of raw materials, consumables and supplies	-438,985	-389,981
Cost of purchased services	-34,566	-29,767
	-473,551	-419,748

The raw materials and consumables used lead to a ratio of 43.7% (2017: 41.3%). Also in relation to the total value, raw materials and consumables used are, with a ratio of 43.1%, above last year's level (2017: 41.2%). The increase is mainly due to higher raw material prices and inventory build-up.

The entities acquired in 2018, Kimplas and Statek, contributed EUR 10,087 thousand to raw materials and consumables used. Due to the previously existing

supply relationship, a majority of Statek's stated material costs was already included in the material costs of NORMA Group.

10. OTHER OPERATING INCOME

Other operating income comprised the following:

T 062 OTHER OPERATING INCOME		
IN EUR THOUSANDS	2018	2017
Currency gains operational	7,567	5,623
Reversal of provisions	616	1,064
Reversal of accruals	3,258	7,200
Grants related to employee benefits expense	23	46
Reimbursement of vehicle costs	873	890
Other income from disposal of fixed assets	139	120
Foreign exchange derivatives	700	1,354
Government grants	603	409
Refund other taxes	359	997
Others	1,451	1,772
	15,589	19,475

Income from the reversal of liabilities and unused provisions is mainly due to the reversal of personnel-related obligations.

11. OTHER OPERATING EXPENSES

Other operating expenses comprised the following:

T 063 OTHER OPERATING EXPENSES		
IN EUR THOUSANDS	2018	2017
Consulting and marketing	- 17,136	- 17,908
Expenses for temporary workforce and other personnel-related costs	- 32,958	- 31,181
Freights	- 29,109	- 24,358
IT and telecommunications	- 15,788	- 15,280
Rentals and other building costs	- 12,528	- 11,654
Travel and entertainment	- 9,591	- 10,263
Currency losses operational	- 8,475	- 7,823
Research & development	- 3,837	- 3,310
Vehicle costs	- 4,583	- 4,447
Maintenance	- 3,504	- 3,533
Commission payable	- 6,114	- 5,560
Non-income-related taxes	- 2,574	- 2,844
Insurance	- 2,532	- 2,497
Office supplies and services	- 2,495	- 2,954
Other administrative expenses	- 5,776	- 4,663
Others	- 5,016	- 4,884
	- 162,016	- 153,159

Other operating expenses for 2018 (EUR 162,016 thousand) were 5.8% higher than other operating expenses for 2017 (EUR 153,159 thousand). In relation to the total value, other operating expenses increased disproportionately lower with a ratio of 14.7% (2017: 15.0%).

The entities acquired in 2018, Kimplas and Statek, contributed expenses in the amount of EUR 2,036 thousand to other operating expenses.

12. EMPLOYEE BENEFITS EXPENSE

Employee benefits expense comprised the following:

T 064 EMPLOYEE BENEFITS EXPENSE

IN EUR THOUSANDS	2018	2017
Wages and salaries and other termination benefits	- 230,815	- 220,854
Social security costs	- 39,748	- 37,734
Pension costs – defined contribution plans	- 11,016	- 10,902
Pension costs – defined benefit plans	- 1,189	- 747
	- 282,768	- 270,237

In 2018, employee benefits expense amounted to EUR 282,768 thousand compared to EUR 270,237 thousand in 2017. The increase of 4.6% is mainly due to an increase in the average headcount in 2018 compared to 2017. Currency effects had a positive effect on employee benefits expense. In relation to the total value, employee benefits expense increased disproportionately lower with a ratio of 25.7% (2017: 26.5%). This was in particular also due to the lower accruals for employee bonuses.

The average headcount was 6,614 in 2018 (2017: 5,791).

The entities acquired in 2018, Kimplas and Statek, contributed EUR 2,674 thousand to employee benefits expense.

13. FINANCIAL INCOME AND COSTS

Financial income and costs comprised the following:

T 065 FINANCIAL INCOME AND COSTS

IN EUR THOUSANDS	2018	2017
Financial costs		
Interest expenses		
Bank borrowings incl. hedging instruments	- 13,282	- 13,708
Finance lease	- 6	- 10
Expenses for interest accrued on provisions	8	- 55
Expenses for interest accrued on pensions	- 124	- 124
Foreign exchange result on financing activities	715	- 5,911
Result on valuation of derivatives	- 436	4,552
Other financial cost	- 1,246	- 1,723
	- 14,371	- 16,979
Financial income		
Interest income on short-term bank deposits	484	396
Other financial income	2,219	528
	2,703	924
Net financial cost	- 11,668	- 16,055

The interest expenses from bank borrowings include in 2018 EUR 13,344 thousand from borrowings (2017: EUR 12,437 thousand) and EUR 62 thousand are related to interest income from hedging derivatives (2017: interest expenses of EUR 1,271 thousand).

Due to the stronger US dollar spot rate compared to the prior year, the foreign exchange result on financing activities shows in fiscal year 2018 income in the amount of EUR 715 thousand compared to expenses in the amount of EUR 5,911 thousand in fiscal year 2017.

In fiscal year 2018, net losses from the valuation of derivatives amount to EUR 436 thousand compared to net gains in the amount of EUR 4,552 thousand in fiscal year 2017.

The development of losses on valuation of derivatives as well as of foreign exchange result on financing activities results from the hedging of the US dollar financial liabilities and from the development of the US dollar compared to the prior year. The hedging relationship is classified as a fair value hedge, hence the

valuation effects of the derivatives and of the financial liabilities are both reflected in the financial result. The net effect is disclosed in ► **NOTE 14 'NET FOREIGN EXCHANGE GAINS /LOSSES.'**

Other financial income mainly includes income from the adjustment of the liability from the option to acquire the outstanding non-controlling interests of a subsidiary. ► **NOTE 20(E) 'FINANCIAL LIABILITIES AND NET DEBT'**

Transaction costs in connection with financing are netted with the bank borrowings. They are amortized over the financing period of the respective debt using the effective interest method. As of December 31, 2018, the value of transaction costs recognized in the balance sheet and amortized over the maturities of the bank borrowings amounted to EUR 810 thousand (2017: EUR 1,114 thousand).

14. NET FOREIGN EXCHANGE GAINS/LOSSES

The exchange differences recognized in profit or loss are as follows:

T 066 NET FOREIGN EXCHANGE GAINS/LOSSES

IN EUR THOUSANDS	Note	2018	2017
Currency gains operational	(10)	7,567	5,623
Currency losses operational	(11)	-8,475	-7,823
Foreign exchange result on financing activities	(13)	715	-5,911
Result from foreign exchange rate derivatives	(13, 20)	-343	5,669
		-536	-2,442

15. EARNINGS PER SHARE

Earnings per share are calculated by dividing net income for the period attributable to NORMA Group's shareholders by the weighted average number of shares issued during the period under review. NORMA Group has only issued common shares. In 2018, as in the previous year, the average weighted number of shares was 31,862,400.

As of December 31, 2018, and 2017, there were no dilutive effects on earnings per share.

Earnings per share in 2018 and 2017 were as follows:

T 067 EARNINGS PER SHARE

	2018	2017
Profit attributable to shareholders of the parent (in EUR thousands)	91,873	119,664
Number of weighted shares	31,862,400	31,862,400
Earnings per share (un)diluted (in EUR)	2.88	3.76

16. INCOME TAXES

The breakdown of income taxes is as follows:

T 068 INCOME TAXES

IN EUR THOUSANDS	2018	2017
Current tax expenses	-34,629	-34,594
Deferred tax income	4,540	32,678
Total income taxes	-30,089	-1,916

The combined income tax rate for the German companies for 2018 amounted to 30.1% (2017: 30.1%), comprising corporate income tax at a rate of 15%, the solidarity surcharge of 5.5% on corporate income tax, and trade income tax at an average rate of 14.3%. The taxation of the foreign subsidiaries is calculated on the basis of the tax rate applicable in the respective country of domicile. Deferred taxes, calculated using the tax rates which apply respectively, are expected to apply in the various countries at the time of realization.

The income tax expense of the Group actually reported differs from the theoretical income tax expense based on the German combined income tax rate of 30.1% for 2018 as follows:

106 Consolidated
Statement of
Comprehensive
Income107 Consolidated
Statement of
Financial Position108 Consolidated
Statement of
Cash Flows109 Consolidated
Statement of
Changes in Equity**110 Notes to the
Consolidated Financial
Statements**197 Appendix to the Notes
to the Consolidated
Financial Statements200 Responsibility
Statement201 Independent
Auditor's Report**T 069 TAX RECONCILIATION**

IN EUR THOUSANDS	2018	2017
Profit before tax	121,877	121,732
Group tax rate	30.1%	30.1%
Expected income taxes	- 36,685	- 36,641
Tax effects of:		
Tax losses and tax credits from the actual year for which no deferred income tax is recognized	- 861	- 1,371
Effects from the deviation of the Group tax rate resulting mainly from different foreign tax rates	9,203	1,298
Non-deductible expenses for tax purposes	- 1,692	- 1,145
Other tax-free income	1,088	896
Tax effect of changes in tax rates regarding deferred taxes	- 260	33,896
Income taxes related to prior years	158	1,679
Impairment of tax assets	- 9	0
Other	- 1,031	- 528
Income taxes	- 30,089	- 1,916

The positive effect in 2017 within the position 'Tax effect of changes in tax rates regarding deferred taxes' results from the one-time effect in deferred tax income amounting to EUR 33,909 thousand due to the reduction of the corporate income tax rate in the US.

The item 'Income taxes related to prior years' regarding 2017 consists of income from the adjustment of tax loss carry forwards reported in prior years.

The item 'Other' consists mainly of other income-based taxes (e. g., withholding tax) in 2018 and 2017.

The income tax charged/credited directly to other comprehensive income during the year is as follows:

**T 070 INCOME TAX CHARGED/CREDITED TO OTHER
COMPREHENSIVE INCOME**

2018	Before tax amount	Tax charge/credit	Net of tax amount
IN EUR THOUSANDS			
Cash flow hedges gains/losses	948	- 267	681
Remeasurements of post-employment benefit obligations	- 265	51	- 214
Other comprehensive income	683	- 216	467
2017			
IN EUR THOUSANDS			
Cash flow hedges gains/losses	664	- 275	389
Remeasurements of post-employment benefit obligations	- 458	137	- 321
Other comprehensive income	206	- 138	68



NOTES TO THE CONSOLIDATED STATEMENT OF FINANCIAL POSITION

17. DEFERRED INCOME TAX

The analysis of deferred tax assets and deferred tax liabilities due to maturity is as follows:

T 071 DEFERRED TAX ASSETS AND DEFERRED TAX LIABILITIES

IN EUR THOUSANDS	Dec 31, 2018	Dec 31, 2017
Deferred tax assets		
Deferred tax assets to be recovered after more than 12 months	1,500	1,185
Deferred tax assets to be recovered within 12 months	5,071	3,660
Deferred tax assets	6,571	4,845
Deferred tax liabilities		
Deferred tax liabilities to be recovered after more than 12 months	71,430	59,982
Deferred tax liabilities to be recovered within 12 months	1,669	561
Deferred tax liabilities	73,099	60,543
Deferred tax liabilities (net)	66,528	55,698

The movement in deferred income tax assets and liabilities during the year is as follows:

T 072 MOVEMENT IN DEFERRED TAX ASSETS AND LIABILITIES

IN EUR THOUSANDS	2018	2017
Deferred tax liabilities (net) – as of January 1	55,698	94,282
Deferred tax income	-4,540	-32,678
Tax charged to other comprehensive income	216	138
Foreign exchange rate differences	1,123	-9,211
Acquisition of subsidiaries	14,031	3,167
Deferred tax liabilities (net) – as of December 31	66,528	55,698

The analysis of deferred income tax assets and deferred income tax liabilities without taking into consideration the offsetting of balances within the same tax jurisdiction is as follows:

T 073 DEFERRED INCOME TAX ASSETS

IN EUR THOUSANDS	Dec 31, 2018	Dec 31, 2017
Intangible assets	2,556	2,750
Property, plant and equipment	692	269
Other assets	806	621
Inventories	1,812	1,620
Trade receivables	1,291	560
Retirement benefit obligations/pension liabilities	2,205	1,283
Provisions	491	622
Borrowings	1,347	177
Other liabilities, incl. derivatives	2,505	2,009
Trade and other payables	559	536
Tax loss carry forward and tax credits	2,962	1,758
Deferred tax assets (before valuation allowances)	17,226	12,205
Valuation allowance	-1,847	-31
Deferred tax assets (before offsetting)	15,379	12,174
Offsetting effects	-8,808	-7,329
Deferred tax assets	6,571	4,845

106 Consolidated
Statement of
Comprehensive
Income107 Consolidated
Statement of
Financial Position108 Consolidated
Statement of
Cash Flows109 Consolidated
Statement of
Changes in Equity**110 Notes to the
Consolidated Financial
Statements**197 Appendix to the Notes
to the Consolidated
Financial Statements200 Responsibility
Statement201 Independent
Auditor's Report**T 074 DEFERRED INCOME TAX LIABILITIES**

IN EUR THOUSANDS	Dec 31, 2018	Dec 31, 2017
Intangible assets	60,287	49,757
Property, plant and equipment	14,703	12,205
Other assets	3,801	1,944
Inventories	179	231
Trade receivables	325	298
Borrowings	6	899
Provisions	255	1,773
Other liabilities, incl. derivatives	2,005	298
Trade and other payables	41	467
Untaxed reserves	305	0
Deferred tax liabilities (before offsetting)	81,907	67,872
Offsetting effects	-8,808	-7,329
Deferred tax liabilities	73,099	60,543
Deferred tax liabilities (net)	66,528	55,698

Changes in deferred income tax liabilities in connection with intangible assets mainly result from the entities acquired in 2018. ► **NOTE 32 'BUSINESS COMBINATIONS'**

Deferred income tax assets are recognized for all deductible temporary differences to the extent that it is probable that future taxable profits will be available against which the deductible temporary difference can be utilized. As of December 31, 2018, and also in the previous year, deferred tax assets were recognized for all deductible temporary differences because sufficient taxable income will most likely be available to utilize these deductible temporary differences.

In 2018 and prior years, the Group had tax losses at several subsidiaries in several countries.

Deferred income tax assets are recognized for tax loss carry forwards as far as it is expected that the deferred tax assets will be utilized in the foreseeable future.

Deferred income tax assets for unused tax losses and unused tax credits developed as follows:

T 075 EXPIRY OF RECOGNIZED TAX LOSSES

IN EUR THOUSANDS	Dec 31, 2018	Dec 31, 2017
up to 1 year	2,505	19
> 1 year up to 5 years	450	2,132
> 5 years	1,671	1,327
Unlimited carry forward	4,643	6,668
Total	9,269	10,146

The Group did not recognize deferred income tax assets in respect of tax loss carry forwards amounting to EUR 6,189 thousand on December 31, 2018 (Dec 31, 2017: EUR 9,029 thousand).

The expiration of tax loss carry forwards not recognized for tax purposes is as follows:

T 076 EXPIRY OF NOT RECOGNIZED TAX LOSSES

IN EUR THOUSANDS	Dec 31, 2018	Dec 31, 2017
Up to 1 year	1,546	0
> 1 year up to 5 years	0	2,605
> 5 years	0	0
Unlimited carry forward	4,643	6,424
Total	6,189	9,029

Regarding taxable temporary differences amounting to EUR 365,100 thousand on December 31, 2018 (Dec 31, 2017: EUR 298,636 thousand), associated with investments in subsidiaries, no deferred tax liabilities are recognized since the respective parent is able to control the timing of the reversal of the temporary difference and it is probable that the temporary difference will not reverse in the foreseeable future.

18. GOODWILL AND OTHER INTANGIBLE ASSETS

The acquisition costs as well as accumulated amortization and impairment of intangible assets consist of the following:

T 077 DEVELOPMENT OF GOODWILL AND OTHER INTANGIBLE ASSETS

IN EUR THOUSANDS	As of Jan 1, 2018	Additions	Deductions	Transfers	Changes in consolidation	Currency effects	As of Dec 31, 2018
Acquisition costs							
Goodwill	389,962	0	0	0	23,822	10,134	423,918
Customer lists	243,447	0	0	0	20,228	8,834	272,509
Licenses, rights	1,900	7	0	5	0	8	1,920
Software acquired externally	41,056	1,576	-44	171	244	278	43,281
Trademarks	51,667	0	0	0	1,865	2,327	55,859
Patents & technology	49,541	669	0	0	18,782	1,403	70,395
Internally generated intangible assets	16,948	5,758	0	16	0	391	23,113
Intangible assets, other	7,788	1,010	0	-121	0	-126	8,551
Total	802,309	9,020	-44	71	64,941	23,249	899,546
Amortization and impairment							
Goodwill	33,245	0	0	0	0	1,168	34,413
Customer lists	67,753	17,500	0	0	0	2,392	87,645
Licenses, rights	1,711	50	0	0	0	10	1,771
Software acquired externally	30,864	4,444	-38	0	0	269	35,539
Trademarks	10,941	1,430	0	0	0	518	12,889
Patents & technology	30,715	4,021	0	0	0	1,163	35,899
Internally generated intangible assets	7,625	3,729	-3	0	0	177	11,528
Intangible assets, other	7,009	80	0	0	0	-126	6,963
Total	189,863	31,254	-41	0	0	5,571	226,647

continue on next page ►

T 077 DEVELOPMENT OF GOODWILL AND OTHER INTANGIBLE ASSETS (CONTINUED)

IN EUR THOUSANDS	As of Jan 1, 2017	Additions	Deductions	Transfers	Changes in consolidation	Currency effects	As of Dec 31, 2017
Acquisition costs							
Goodwill	405,496	0	0	0	11,709	-27,243	389,962
Customer lists	261,752	0	0	0	9,741	-28,046	243,447
Licenses, rights	1,908	16	-8	23	0	-39	1,900
Software acquired externally	37,548	1,734	-48	2,803	0	-981	41,056
Trademarks	58,013	0	0	0	419	-6,765	51,667
Patents & technology	52,896	609	0	0	547	-4,511	49,541
Internally generated intangible assets	12,242	4,642	0	663	0	-599	16,948
Intangible assets, other	10,373	1,155	0	-3,489	0	-251	7,788
Total	840,228	8,156	-56	0	22,416	-68,435	802,309
Amortization and impairment							
Goodwill	36,637	0	0	0	0	-3,392	33,245
Customer lists	57,394	16,270	0	0	0	-5,911	67,753
Licenses, rights	1,462	290	-8	0	0	-33	1,711
Software acquired externally	26,351	4,904	-35	358	0	-714	30,864
Trademarks	10,837	1,416	0	0	0	-1,312	10,941
Patents & technology	30,512	3,457	0	0	0	-3,254	30,715
Internally generated intangible assets	5,273	2,592	0	0	0	-240	7,625
Intangible assets, other	7,476	117	0	-358	0	-226	7,009
Total	175,942	29,046	-43	0	0	-15,082	189,863

**T 078 GOODWILL AND OTHER INTANGIBLE ASSETS -
CARRYING AMOUNTS**

IN EUR THOUSANDS	Carrying amounts	
	Dec 31, 2018	Dec 31, 2017
Goodwill	389,505	356,717
Customer lists	184,864	175,694
Licenses, rights	149	189
Software acquired externally	7,742	10,192
Trademarks	42,970	40,726
Patents & technology	34,496	18,826
Internally generated intangible assets	11,585	9,323
Intangible assets, other	1,588	779
Total	672,899	612,446

The item 'patents and technology' on December 31, 2018, consists of patents worth EUR 9,797 thousand (Dec 31, 2017: EUR 11,246 thousand) and technology worth EUR 24,699 thousand (Dec 31, 2017: EUR 7,580 thousand).

Internally generated intangible assets mainly include development costs for technologies in the amount of EUR 8,078 thousand (Dec 31, 2017: EUR 7,150 thousand) as well as internally generated software in the amount of EUR 3,507 thousand (Dec 31, 2017: EUR 2,173 thousand).

The item 'Intangible assets, other' consists mainly of prepayments.

The change in goodwill, customer lists and patents & technology mainly results from positive foreign exchange differences, mainly from the US dollar area and from the acquisition of Kimplas and Statek. ► **NOTE 32 'BUSINESS COMBINATIONS'**

106 Consolidated Statement of Comprehensive Income
107 Consolidated Statement of Financial Position
108 Consolidated Statement of Cash Flows
109 Consolidated Statement of Changes in Equity
110 Notes to the Consolidated Financial Statements
197 Appendix to the Notes to the Consolidated Financial Statements
200 Responsibility Statement
201 Independent Auditor's Report

The change in goodwill is summarized as follows:

T 079 CHANGE IN GOODWILL

IN EUR THOUSANDS

Balance as of December 31, 2017	356,717
Changes in consolidation	23,822
Kimplas	20,037
Statek	3,785
Currency effect	8,966
Balance as of December 31, 2018	389,505

Besides the goodwill, there are intangible assets within trademarks with an indefinite useful life in the amount of EUR 27,860 thousand (2017: EUR 26,599 thousand) resulting from the acquisition of NDS in 2014. From a market perspective, NORMA Group assumed an indefinite useful life for these acquired trademarks, which mainly include the corporate brand NDS®, because these brands have been established in the market for a number of years and there is no foreseeable end to their useful life, therefore useful lives are indefinite. Trademarks with indefinite useful lives are fully allocated to the cash-generating unit (CGU) Americas.

Trademarks with an unknown term of use are subjected to an annual impairment test pursuant to IAS 36 on the basis of the recoverable amount pursuant to the procedure described in ► **NOTE 3 'SUMMARY OF SIGNIFICANT ACCOUNTING POLICIES – IMPAIRMENT OF NON-FINANCIAL ASSETS.'**

On December 31, 2018, and 2017, the intangible assets were unsecured.

IMPAIRMENT TESTS FOR GOODWILL

Goodwill is allocated to the Group's cash-generating units (CGUs) identified according to geographical areas. A summary of the goodwill allocation is presented below:

T 080 GOODWILL ALLOCATION PER SEGMENT

IN EUR THOUSANDS	Dec 31, 2018	Dec 31, 2017
CGU EMEA	178,540	174,297
CGU Americas	176,500	167,648
CGU Asia-Pacific	34,465	14,772
	389,505	356,717

Goodwill for the CGU EMEA increased in 2018 due to the acquisition of Statek in Germany amounting to EUR 3,785 thousand and due to currency effects. Goodwill for the CGU Americas increased in 2018 mainly due to currency effects. Goodwill for the CGU Asia-Pacific was increased by the acquisition of Kimplas in India amounting to EUR 20,037. Currency effects had a slightly opposite effect.

The recoverable amount of a CGU is determined based on fair value less costs to sell, which is calculated by discounting projected cash flows. Based on the inputs used for this valuation technique, fair values are classified as level 3 fair values. ► **NOTE 3 'SUMMARY OF SIGNIFICANT ACCOUNTING POLICIES – FAIR VALUE ESTIMATION'** These calculations use cash flow projections based on financial budgets approved by the management covering a five-year period. Cash flows beyond the five-year period are extrapolated using the estimated growth rates stated below. The growth rate does not exceed our expectations for the long-term average growth rate for the geographical area of the respective CGU.

The discount rates used are after tax rates and reflect the specific risk of each CGU. The respective before tax rates are 10.61% (2017: 11.45%) for the CGU EMEA, 8.86% (2017: 9.58%) for the CGU Americas, and 10.74% (2017: 10.91%) for the CGU Asia-Pacific.

106 Consolidated Statement of Comprehensive Income
107 Consolidated Statement of Financial Position
108 Consolidated Statement of Cash Flows
109 Consolidated Statement of Changes in Equity
110 Notes to the Consolidated Financial Statements
197 Appendix to the Notes to the Consolidated Financial Statements
200 Responsibility Statement
201 Independent Auditor's Report

The key assumptions used for fair value less costs to sell calculations are as follows:

T 081 GOODWILL PER SEGMENT – KEY ASSUMPTIONS

December 31, 2018	CGU EMEA	CGU Americas	CGU Asia-Pacific
Terminal value growth rate	1.50%	1.50%	1.50%
Discount rate	8.40%	7.15%	8.44%
Costs to sell	1.00%	1.00%	1.00%

December 31, 2017	CGU EMEA	CGU Americas	CGU Asia-Pacific
Terminal value growth rate	1.50%	1.50%	1.50%
Discount rate	8.96%	7.72%	8.63%
Costs to sell	1.00%	1.00%	1.00%

The assumptions are based on management's expectations regarding future developments.

The Group has performed a sensitivity analysis in which EBITA was decreased by 10%. This change would not cause the carrying amount to exceed its recoverable amount in any CGU. Even if the discount rate would increase by +2% and the terminal value growth rate would be 0%, the change of these key assumptions would not cause the carrying amount to exceed its recoverable amount in any CGU.

IMPAIRMENT LOSSES ON OTHER INTANGIBLE ASSETS

An impairment test on customer lists of Fengfan, a Chinese subsidiary, was conducted in the second half of the year after observing a significant decrease in the related forecasted sales revenue. The reason for this reduction was attributed to the loss of several customers (triggering event) which the management considered to be an indicator of potential impairment resulting in a downward revision of the projected cash flows. A new estimate of expected cash flow attributed to the customer list was prepared which resulted in the recoverable amount being lower than the carrying amount. Consequently, an impairment charge amounting to EUR 1.4 million was recognized within the amortization, reducing the carrying amount to the recoverable amount.

The fair value of the customer lists was determined using the residual value method based on level 3 inputs. The residual value method estimates the fair value by determining the present value of the future economic returns expected from the customers over their useful lives. The earnings were taken from the mid-term planning (own data) as there was no other available information that indicated that market participants would use different assumptions / data.

Key assumptions used in determining the fair value of the customer lists are:

T 082 ASSUMPTIONS IMPAIRMENT

Proportion of total revenue driven from acquired customers	This figure was determined after a thorough analysis of the current circumstances while taking into account historical and forecasted data.	89%
Pre-tax risk adjusted discount rate	The WACC was calculated specifically for the subsidiary by considering its specific business risk and financial risk.	6.69%
Tax rate	The last available standalone marginal corporate tax rate of the subsidiary was used (FY 2018).	25%
EBITDA margin	The EBITDA margin has been set in line with the expectations of the management of the subsidiary after an analysis of the market conditions.	13.4%
Attrition factor	Since the useful life of the asset is 8 years, the factor is expected to reduce every year by 12.5%.	12.5%

Besides the aforementioned impairment, no material impairments for intangible assets or write-ups were recognized in 2018 and 2017.

19. PROPERTY, PLANT AND EQUIPMENT

The acquisition and manufacturing costs as well as accumulated depreciation of property, plant and equipment consist of the following:

T 083 DEVELOPMENT OF PROPERTY, PLANT AND EQUIPMENT

IN EUR THOUSANDS	As of Jan 1, 2018	Additions	Deductions	Transfers	Changes in consolidation	Currency effects	As of Dec 31, 2018
Acquisition costs							
Land and buildings	111,560	2,332	-312	1,912	5,112	96	120,700
Machinery & tools	302,020	15,459	-1,367	17,059	8,121	2,314	343,606
Other equipment	65,565	2,998	-1,205	1,171	1,030	69	69,628
Assets under construction	22,021	33,446	-242	-20,213	1,309	395	36,716
Total	501,166	54,235	-3,126	-71	15,572	2,874	570,650
Depreciation and impairment							
Land and buildings	51,181	3,098	-53	0	0	-94	54,132
Machinery & tools	196,162	23,365	-951	0	0	1,205	219,781
Other equipment	48,641	5,708	-959	0	0	-12	53,378
Assets under construction	29	4	0	0	0	0	33
Total	296,013	32,175	-1,963	0	0	1,099	327,324
IN EUR THOUSANDS							
Acquisition costs							
Land and buildings	109,553	1,867	-273	891	1,309	-1,787	111,560
Machinery & tools	278,937	15,314	-4,538	20,578	3,210	-11,481	302,020
Other equipment	60,774	4,876	-933	1,596	220	-968	65,565
Assets under construction	30,257	17,520	-538	-23,065	-432	-1,721	22,021
Total	479,521	39,577	-6,282	0	4,307	-15,957	501,166
Depreciation and impairment							
Land and buildings	48,654	3,042	-223	0	0	-292	51,181
Machinery & tools	184,694	21,181	-4,302	0	0	-5,411	196,162
Other equipment	44,967	5,198	-797	0	0	-727	48,641
Assets under construction	29	0	0	0	0	0	29
Total	278,344	29,421	-5,322	0	0	-6,430	296,013

106 Consolidated
Statement of
Comprehensive
Income

107 Consolidated
Statement of
Financial Position

108 Consolidated
Statement of
Cash Flows

109 Consolidated
Statement of
Changes in Equity

110 Notes to the
Consolidated Financial
Statements

197 Appendix to the Notes
to the Consolidated
Financial Statements

200 Responsibility
Statement

201 Independent
Auditor's Report

106 Consolidated
Statement of
Comprehensive
Income107 Consolidated
Statement of
Financial Position108 Consolidated
Statement of
Cash Flows109 Consolidated
Statement of
Changes in Equity**110 Notes to the
Consolidated Financial
Statements**197 Appendix to the Notes
to the Consolidated
Financial Statements200 Responsibility
Statement201 Independent
Auditor's Report**T 084 PROPERTY, PLANT AND EQUIPMENT – CARRYING AMOUNTS**

IN EUR THOUSANDS	Carrying amounts	
	Dec 31, 2018	Dec 31, 2017
Land and buildings	66,568	60,379
Machinery & tools	123,825	105,858
Other equipment	16,250	16,924
Assets under construction	36,683	21,992
Total	243,326	205,153

On December 31, 2018, the item 'Machinery and tools' included tools valued at EUR 28,166 thousand (Dec 31, 2017: EUR 25,254 thousand).

No material impairment and no material write-ups were recognized on property, plant and equipment in 2018 and 2017.

On December 31, 2018, and 2017, property, plant and equipment, except for finance lease assets, were unsecured.

Land and buildings includes the following amounts where the Group is a lessee under a finance lease:

T 085 FINANCE LEASES – LAND AND BUILDINGS

IN EUR THOUSANDS	Dec 31, 2018	Dec 31, 2017
Cost – capitalized finance leases	4,701	863
Accumulated depreciation	– 129	– 74
Net carrying amount	4,572	789

Machinery includes the following amounts where the Group is a lessee under a finance lease:

T 086 FINANCE LEASES – MACHINERY

IN EUR THOUSANDS	Dec 31, 2018	Dec 31, 2017
Cost – capitalized finance leases	80	128
Accumulated depreciation	– 64	– 73
Net carrying amount	16	55

Other equipment includes the following amounts where the Group is a lessee under a finance lease:

T 087 FINANCE LEASES – OTHER EQUIPMENT

IN EUR THOUSANDS	Dec 31, 2018	Dec 31, 2017
Cost – capitalized finance leases	22	203
Accumulated depreciation	– 17	– 119
Net carrying amount	5	84

The Group leases various property, machinery, technical and IT equipment under non-cancellable finance lease agreements. The lease terms for machinery and other equipment are between three and ten years, while the lease terms for land and building are up to 50 years.

20. FINANCIAL INSTRUMENTS

The following disclosures provide an overview of the financial instruments held by the Group, detailed information about each type of financial instrument held and information about the accounting policies used.

Financial instruments according to classes and categories were as follows:

T 088 FINANCIAL INSTRUMENTS – CLASSES AND CATEGORIES

IN EUR THOUSANDS	Note	Category IFRS 7.8 according to IFRS 9	Measurement basis IFRS 9				
			Carrying amount Dec 31, 2018	Amortized cost	Fair value through profit or loss	Derivatives used for hedging	Measure- ment basis IAS 17
Financial assets							
Derivative financial instruments – hedge accounting							
	20. (f)						
		n/a	2,571			2,571	2,571
		n/a	151			151	151
		n/a	42			42	42
		Amortized					
	20. (a)	Cost	128,485	128,485			128,485
	20. (b)	FVTPL	14,653		14,653		14,653
		Amortized					
		Cost	5,231	5,231			5,231
		Amortized					
	20. (c)	Cost	190,392	190,392			190,392
Financial liabilities							
	20. (d)	FLAC	569,091	569,091			582,624
Derivative financial instruments – hedge accounting							
	20. (f)						
		n/a	675			675	675
		n/a	45			45	45
		n/a	38			38	38
	20. (d)	FLAC	142,028	142,028			142,028
Other financial liabilities							
	20. (e)						
		FLAC	20,826	20,826			20,826
		n/a	32				32
Totals per category							
			324,108	324,108			324,108
			14,653		14,653		14,653
			731,945	731,945			745,478

continued on next page ►

INTRODUCTION

OUR VISION

TO OUR SHAREHOLDERS

CONSOLIDATED
MANAGEMENT REPORT

**CONSOLIDATED
FINANCIAL STATEMENTS**

FURTHER INFORMATION

106 Consolidated
Statement of
Comprehensive
Income

107 Consolidated
Statement of
Financial Position

108 Consolidated
Statement of
Cash Flows

109 Consolidated
Statement of
Changes in Equity

**110 Notes to the
Consolidated Financial
Statements**

197 Appendix to the Notes
to the Consolidated
Financial Statements

200 Responsibility
Statement

201 Independent
Auditor's Report

T088 FINANCIAL INSTRUMENTS – CLASSES AND CATEGORIES (CONTINUED)

IN EUR THOUSANDS	Category IAS 39	Measurement basis IAS 39				Fair value Dec 31, 2017
		Carrying amount Dec 31, 2017	Amortized cost	Fair value through profit or loss	Derivatives used for hedging	
Financial assets						
Derivative financial instruments – hedge accounting						
Interest rate swaps – cash flow hedges	n/a	1,885			1,885	1,885
Foreign exchange derivatives – cash flow hedges	n/a	458			458	458
Foreign exchange derivatives – fair value hedges	n/a	182			182	182
Trade and other receivables	LaR	152,746	152,746			152,746
Other financial assets	LaR	1,001	1,001			1,001
Cash and cash equivalents	LaR	155,323	155,323			155,323
Financial liabilities						
Borrowings	FLAC	488,247	488,247			504,621
Derivative financial instruments – hedge accounting						
Interest rate swaps – cash flow hedges	n/a	1,226			1,226	1,226
Foreign exchange derivatives – cash flow hedges	n/a	43			43	43
Foreign exchange derivatives – fair value hedges	n/a	150			150	150
Trade and other payables	FLAC	145,749	145,749			145,749
Other financial liabilities						
Other liabilities	FLAC	10,375	10,375			10,375
Finance lease liabilities	n/a	156				156
Totals per category						
Loans and receivables (LaR)		309,070	309,070			309,070
Financial liabilities at amortized cost (FLAC)		644,371	644,371			660,745

106 Consolidated Statement of Comprehensive Income
107 Consolidated Statement of Financial Position
108 Consolidated Statement of Cash Flows
109 Consolidated Statement of Changes in Equity
110 Notes to the Consolidated Financial Statements
197 Appendix to the Notes to the Consolidated Financial Statements
200 Responsibility Statement
201 Independent Auditor's Report

20. (A) TRADE AND OTHER RECEIVABLES

Trade and other receivables were as follows:

T089 TRADE AND OTHER RECEIVABLES

IN EUR THOUSANDS	Dec 31, 2018	Dec 31, 2017
Trade receivables	135,771	147,872
Other receivables	7,367	4,874
	143,138	152,746

Other receivables mainly include banker's acceptance bills for trade receivables for customers in China. These financial assets are generally required to collect contractual cash flows and are allocated to the "hold" business model accordingly and are initially recognized at fair value plus transaction costs and are subsequently carried at amortized cost using the effective interest method less any impairment losses.

On the balance sheet date, trade receivables were as follows:

T090 TRADE RECEIVABLES

IN EUR THOUSANDS	Dec 31, 2018	Dec 31, 2017
Trade receivables	137,425	150,424
Less allowances for doubtful accounts	-1,654	-2,552
	135,771	147,872

i. Classification as trade receivables

Trade receivables are amounts payable by customers for goods sold or services rendered in the ordinary course of business. If the receivables are expected to be settled within twelve months, they are classified as current assets. If this is exceptionally not the case, they are reported as non-current assets. Trade receivables are classified in accordance with IFRS 9. They are generally required to collect the contractual cash flows and are allocated to the "hold" business model accordingly. They are recognized initially at the amount of the unconditional consideration and are subsequently carried at amortized cost using the effective interest method less any impairment losses. If trade receivables contain a significant financing component, they are initially recognized at fair value.

ii. Impairment and write-offs of trade receivables

For trade receivables, the simplified approach, which is based on the expected credit losses over the respective terms, is used. Loss rates calculated on the basis of historical and forecast data are used, taking into account the business model, the respective customer and the economic environment of the geographical region.

On this basis, the allowance for trade receivables and contract assets as of December 31, 2018, and January 1, 2018, (to adopt IFRS 9) was determined as follows:

106 Consolidated
Statement of
Comprehensive
Income107 Consolidated
Statement of
Financial Position108 Consolidated
Statement of
Cash Flows109 Consolidated
Statement of
Changes in Equity**110 Notes to the
Consolidated Financial
Statements**197 Appendix to the Notes
to the Consolidated
Financial Statements200 Responsibility
Statement201 Independent
Auditor's Report**T 091 CREDIT RISK EXPOSURE TRADE RECEIVABLES****As of December 31, 2018**

IN EUR THOUSANDS	Credit loss rate < 1%	Credit loss rate ≥ 1% ≤ 2.5%	Credit loss rate > 2.5%	Total
Trade receivables – before allowances	66,895	47,694	8,183	122,772
Lifetime - ECL allowance	488	892	274	1,654
Trade receivables – after allowances	66,407	46,802	7,909	121,118

The impairment losses on trade receivables developed as follows from the opening balance sheet value as of January 1, 2018, to the closing balance sheet value as of December 31, 2018:

T 092 IMPAIRMENT RECONCILIATION

IN EUR THOUSANDS	Impairments on trade receivables
Impairment allowance as of Jan 1, 2018 - based on IFRS 9	1,571
Additions	445
Reversals	- 383
Translation effect	21
Impairment allowance as of Dec 31, 2018 - based on IFRS 9	1,654

Impairment losses on trade receivables, together with those on contract assets, are recognized in operating profit as net impairment losses. Unused amounts reversed are included in the same line item. The net expenses recognized in fiscal year 2018 from these impairment losses amounted to EUR 62 thousand.

Receivables with significant arrears, which may be more than 180 days due to the customer structure, or those for which insolvency or similar proceedings have been initiated, are individually tested for impairment. If, on the basis of an appropriate assessment, it cannot be assumed that these can be realized, they are written off directly. In the fiscal year, the following losses resulted from the write-off of trade receivables:

T 093 GAINS/ LOSSES ARISING FROM DERECOGNITION IFRS 7.20A

IN EUR THOUSANDS	2018	2017	Reasons for derecognition
Gains arising from derecognition	0	n/a	
Losses arising from derecognition	507	n/a	Write-off (IFRS 9.5.4.4)

Losses on the disposal of trade receivables through write-offs are recognized in operating profit as impairment losses, net. Unused amounts reversed are included in the same line item.

iii. Fair value of trade receivables

Trade receivables have short-term maturities, therefore the carrying amounts on the balance sheet date correspond to their fair values, as the effects of discounting are not material.

20. (B) TRADE RECEIVABLES TRANSFERRED OR AVAILABLE FOR TRANSFER**i. Transferred trade receivables**

Subsidiaries of NORMA Group in the EMEA and Americas segments transfer trade receivables to external purchasers as part of factoring and ABS transactions. The details and effects of the respective programs are presented below.

a) Factoring transactions

In the factoring agreement concluded in 2017, that has a maximum volume of receivables of EUR 18 million, NORMA Group subsidiaries in Germany and Poland sell trade receivables directly to external purchasers. As part of this factoring program, receivables of EUR 8.6 million were sold as of December 31, 2018, (Dec 31, 2017: EUR 9.0 million).

The requirements for a receivables transfer were met in accordance with IFRS 9.3.2.1 since the receivables were transferred in accordance with IFRS 9.3.2.4 a). Verification in accordance with IFRS 9.3.2.6 shows that nearly all opportunities and risks were neither transferred nor retained. It follows in accordance with IFRS 9.3.2.16 that NORMA Group recognizes remaining continuing involvement.

NORMA Group is continuing to perform receivables management (servicing) for the receivables sold.

106 Consolidated Statement of Comprehensive Income
 107 Consolidated Statement of Financial Position
 108 Consolidated Statement of Cash Flows
 109 Consolidated Statement of Changes in Equity
110 Notes to the Consolidated Financial Statements
 197 Appendix to the Notes to the Consolidated Financial Statements
 200 Responsibility Statement
 201 Independent Auditor's Report

Although NORMA Group is only entitled to act as a servicer, the Company retains the right to dispose of the sold receivables, as purchasers do not have the right to resell the receivables acquired.

NORMA Group is continuing to recognize the sold trade receivable to the extent of its continuing involvement, i.e., at the maximum amount to which it continues to be liable for the late payment risk inherent in the receivables sold. Hence, NORMA Group is recognizing a corresponding financial liability.

The remaining continuing involvement in the amount of EUR 79 thousand (Dec 31, 2017: EUR 82 thousand) was recognized as a financial liability and considers the maximum potential loss for NORMA Group resulting from the late payment risk of receivables sold as of the reporting date. The fair value of the guarantee/interest payments to be assumed has been estimated at EUR 7 thousand Dec 31, 2017: EUR 7 thousand), taken through profit or loss and recognized under other liabilities.

In 2018, NORMA established a further factoring program. Under the factoring agreement concluded in December 2018 with a maximum receivables volume of USD 16 million, a subsidiary of NORMA Group in the US sells trade receivables directly to external purchasers. As part of this factoring program, receivables amounting to EUR 15.4 million were sold as of December 31, 2018. Of this amount, EUR 3.2 million were treated as purchase price retentions and not paid out, but rather held as security reserves and recognized as other financial assets.

The requirements for the derecognition of receivables in accordance with IFRS 9.3.2.1 are met, as the receivables are transferred in accordance with IFRS 9.3.2.4 a). The examination of IFRS 9.3.2.6 shows that essentially all opportunities and risks have been transferred.

NORMA Group continues to service the receivables sold.

Although NORMA Group is not entitled to dispose of the receivables sold in any other way than within the framework of receivables management, the Company retains control over the receivables sold as the buyers do not have the actual ability to resell the acquired receivables.

b) ABS transactions

In 2014, NORMA Group entered into a revolving asset purchase agreement (Receivables Purchase Agreement) with Weinberg Capital Ltd. (special purpose entity). Within the agreed structure, NORMA Group sold trade receivables in the context of an ABS transaction which was successfully initiated in December 2014. Receivables are sold by NORMA Group to a special purpose entity.

As of December 31, 2018, domestic NORMA Group entities had sold receivables in an amount of EUR 15.2 million (Dec 31, 2017: EUR 15.2 million) under this asset-backed securities (ABS) program with a maximum volume of EUR 25 million. From the receivables sold, EUR 0.6 million (Dec 31, 2017: EUR 0.6 million) were retained as loss reserves and not paid out. These assets were recognized as other financial assets. The basis for this transaction is the transfer of trade receivables of individual NORMA Group subsidiaries to a special purpose entity with a framework of undisclosed assignment. This special purpose entity (SPE) is not consolidated under IFRS 10 because neither the power over the SPE is attributable to NORMA Group nor does NORMA Group have an essential self-interest and no connection between power and variability of the returns of the special purpose entity exists.

The requirements for a receivables transfer according to IFRS 9.3.2.1 are met, since the receivables are transferred according to IFRS 9.3.2.4 a). Verification in accordance with IFRS 9.3.2.6 shows that a substantial share of all risks and rewards were neither transferred nor retained. Therefore, according to IFRS 9.3.2.16, NORMA Group's continuing involvement must be recognized.

This continuing involvement in the amount of EUR 272 thousand (Dec 31, 2017: EUR 273 thousand) includes the maximum amount that NORMA Group could conceivably have to pay back under the default guarantee and the expected interest payments until the payment is received for the carrying amount of the receivables transferred. The fair value of the guarantee/interest payments to be assumed has been estimated at EUR 215 thousand (Dec 31, 2017: EUR 192 thousand), taken through profit or loss and recognized under other liabilities.

NORMA Group entered into another agreement with Weinberg Capital Ltd. (program special purpose entity) in fiscal year 2018 by concluding a further revolving receivables purchase agreement on the sale of trade receivables. The agreed structure provides for the sale of trade receivables of NORMA Group as part of an ABS transaction and was successfully initiated in December 2018. The receivables are sold to a special purpose entity by NORMA Group.

As part of this ABS program with a volume of up to USD 30 million, US American Group companies of NORMA Group sold receivables amounting to EUR 22.0 million as of December 31, 2018, of which EUR 0.9 million were not paid out as purchase price retentions, but rather held as security reserves and recognized as other financial assets. The basis for the transaction is the assignment of trade receivables of individual NORMA Group companies to a program special purpose entity as part of a silent assignment. According to IFRS 10, this program special purpose entity is not to be consolidated, as NORMA Group is not assigned any decision-making power, nor is there any material self-interest or link

106 Consolidated Statement of Comprehensive Income
 107 Consolidated Statement of Financial Position
 108 Consolidated Statement of Cash Flows
 109 Consolidated Statement of Changes in Equity
110 Notes to the Consolidated Financial Statements
 197 Appendix to the Notes to the Consolidated Financial Statements
 200 Responsibility Statement
 201 Independent Auditor's Report

between decision-making power and the variability of returns from the program special purpose entity.

The requirements for derecognition of receivables in accordance with IFRS 9.3.2.1 are met, as the receivables are transferred in accordance with IFRS 9.3.2.4 a). The audit of IFRS 9.3.2.6 shows that almost all opportunities and risks have neither been transferred nor retained. In accordance with IFRS 9.3.2.16, NORMA Group must therefore recognize the remaining continuing involvement.

A continuing involvement of EUR 813 thousand was recognized as other financial liability and comprises the maximum amount that NORMA Group might have to repay under the assumed default guarantee and the expected interest payments until receipt of payment in respect of the carrying amount of the receivables transferred. The fair value of the guarantee or of the interest payments to be assumed was included in the carrying amount and recognized as other liabilities in the amount of EUR 287 thousand.

ii. Trade receivables available for transfer

In the opinion of the Group, trade receivables included in these programs but not yet disposed of at the end of the reporting period cannot be allocated to either the “hold” or the “hold and sell” business models. They are therefore included in the fair value through profit and loss (FVTPL) category.

20. (C) CASH AND CASH EQUIVALENTS

Cash and cash equivalents are measured at their nominal value and include cash in hand, deposits held at call with banks, and other short-term highly liquid investments with original maturities of three months or less and which are subject only to insignificant risk of change in value. Bank overdrafts are shown within borrowings in current liabilities in the Consolidated Statement of Financial Position.

20. (D) OTHER FINANCIAL ASSETS

Other financial assets were as follows:

T 094 OTHER FINANCIAL ASSETS

IN EUR THOUSANDS	Dec 31, 2018	Dec 31, 2017
Receivables from ABS program	1,521	638
Receivables from factoring	3,204	0
Other assets	506	363
	5,231	1,001

Receivables from the ABS program and from factoring include reserves for the trade receivables sold. ► **NOTE 20(B) ‘TRADE RECEIVABLES TRANSFERRED OR AVAILABLE FOR TRANSFER’**

Other financial assets are generally required to collect the contractual cash flows and are accordingly allocated to the “hold” business model. They are initially recognized at fair value plus transaction costs and are subsequently carried at amortized cost using the effective interest method less impairment.

20. (E) FINANCIAL LIABILITIES AND NET DEBT

i. Trade and other liabilities

Trade and other payables are as follows:

T 095 TRADE AND OTHER PAYABLES

IN EUR THOUSANDS	Dec 31, 2018	Dec 31, 2017
Trade payables and other payables	109,193	120,351
Reverse factoring liabilities	19,200	25,398
Refund liabilities	13,635	0
	142,028	145,749

Trade payables are obligations to pay for goods or services that have been acquired in the ordinary course of business from suppliers. Accounts payable are classified as current liabilities if payment is due within one year or less. If not, they are presented as non-current liabilities.

Trade payables are recognized initially at fair value and subsequently measured at amortized cost using the effective interest method.

NORMA Group participates in a reverse factoring program. The liabilities included in this program are reported under trade payables and similar liabilities, as this corresponds to the economic content of the transactions.

All trade payables and liabilities from reverse factoring programs are due to third parties within one year. As a result, these have short-term maturities, therefore the carrying amounts on the balance sheet date correspond to their fair values, as the effects of discounting are not material.

Refund liabilities

Reimbursement liabilities are recognized for volume discounts and similar bonus agreements payable to customers. These arise from retrospective volume rebates or similar agreements that are based on total sales or on a specific product sale of a 12-month or shorter period. Refund liabilities are recognized for discounts expected to be payable to the customer for sales completed by the end of the reporting period. For further details, please refer to ► **NOTE 3 'SUMMARY OF SIGNIFICANT ACCOUNTING PRINCIPLES.'**

All reimbursement liabilities are due to third parties within one year. The carrying amounts on the balance sheet date therefore correspond to their fair values, as the effects of discounting are not material.

ii. Bank borrowings

The borrowings were as follows:

T 096 BORROWINGS

IN EUR THOUSANDS	Dec 31, 2018	Dec 31, 2017
Non-current		
Bank borrowings	455,759	455,111
	455,759	455,111
Current		
Bank borrowings	113,332	33,136
	113,332	33,136
Total borrowings	569,091	488,247

Borrowings are recognized initially at fair value, net of directly attributable transaction costs incurred. Borrowings are subsequently stated at amortized cost; any difference between the proceeds (net of transaction costs) and the redemption value is recognized in profit or loss over the period of the borrowings using the effective interest method.

Fees paid on the establishment of loan facilities are recognized as transaction costs of the loan to the extent that it is probable that some or all of the facility will be drawn down. In this case, the fee is deferred until the draw-down occurs. To the extent that there is no evidence that it is probable that some or all of the facility will be drawn down, the fee is capitalized as a pre-payment for liquidity services and amortized over the period of the facility to which it relates.

Borrowings are classified as current liabilities unless the Group has an unconditional right to defer settlement of the liability for at least 12 months after the balance sheet date.

The maturity of the syndicated bank facilities and the promissory note on December 31, 2018, is as follows:

T 097 MATURITY BANK BORROWINGS 2018

IN EUR THOUSANDS	up to 1 year	> 1 year up to 2 years	> 2 years up to 5 years	> 5 years
Syndicated bank facilities, net	4,839	4,839	174,590	0
Promissory note, net	106,103	29,000	161,635	86,500
Total	110,942	33,839	336,225	86,500

The maturity of the syndicated bank facilities and the promissory note on December 31, 2017, is as follows:

T 098 MATURITY BANK BORROWINGS 2017

IN EUR THOUSANDS	up to 1 year	> 1 year up to 2 years	> 2 years up to 5 years	> 5 years
Syndicated bank facilities, net	4,665	4,665	74,648	0
Promissory note, net	26,000	102,544	125,528	148,840
Total	30,665	107,209	200,176	148,840

a) Fair value of bank borrowings

The fair value calculation of the fixed-interest promissory note, which is recognized at amortized cost and for which the fair value is stated in the notes, was based on the market yield curve according to the zero coupon method considering credit spreads (level 2). Interest accrued on the reporting date is included.

b) Financial covenant

The Group is subject to the financial covenant total net debt cover (net debt in relation to adjusted Group EBITDA), which is monitored on an ongoing basis. This financial covenant is based on the Group's Consolidated Financial Statements as well as on special definitions of the bank facility agreements.

There were no covenant breaches in 2018 and 2017.

iii. Other financial liabilities

Other financial liabilities were as follows:

T 099 OTHER FINANCIAL LIABILITIES

IN EUR THOUSANDS	Dec 31, 2018	Dec 31, 2017
Non-current		
Lease liabilities	16	33
Other liabilities	1,976	4,191
	1,992	4,224
Current		
Lease liabilities	16	123
Acquisition liability	546	2,981
Liabilities from ABS and factoring	17,141	467
Other liabilities	1,163	2,736
	18,866	6,307
Total other financial liabilities	20,858	10,531

a) Lease liabilities

To a minor extent, the Group leases property, plant and equipment and land under finance leases with terms of between 1 and 5 years.

The future aggregate minimum lease payments under non-cancellable finance leases and their respective present values are as follows:

T 100 FUTURE MINIMUM LEASE PAYMENTS NON-CANCELLABLE FINANCE LEASES

IN EUR THOUSANDS	Dec 31, 2018	Dec 31, 2017
Gross finance lease liabilities – minimum lease payments		
Up to 1 year	17	123
> 1 year up to 5 years	18	33
> 5 years	0	0
	35	156
Future finance charges on finance lease	3	0
Present value of finance lease liabilities		
Up to 1 year	16	123
> 1 year up to 5 years	16	33
> 5 years	0	0
	32	156

The fair values of finance lease liabilities are calculated as the present values of the payments associated with the debts based on the applicable yield curve and NORMA Group's credit spread curve (level 2).

b) Liabilities from the ABS and factoring

The liabilities from the ABS and factoring include liabilities from continuing involvement in the amount of EUR 1,164 thousand, liabilities from fair values of default and interest guarantees in the amount of EUR 509 thousand recorded under the ABS and factoring programs and liabilities from customer payments for receivables already sold under the ABS and factoring programs in the amount of EUR 15,468 thousand as part of the debtor/receivables management performed by NORMA Group.

c) Other liabilities

As of December 31, 2018, other non-current liabilities include liabilities of EUR 1,976 thousand (2017: EUR 2,981 thousand) for the option to acquire the remaining minority interest in connection with the acquisition of Fengfan Fastener (Shaoxing) Co., Ltd. (Fengfan) in the second quarter of 2017. This option gives NORMA Group the right to acquire the remaining 20% of the shares in Fengfan. The risks and rewards of the remaining shares are not transferred to NORMA Group due to the contractual structure. Consequently, the present value of the

estimated future payment of EUR 3,946 thousand at the time of acquisition is reported under other financial liabilities. Changes in the estimate of the amount to be paid are recognized in the income statement under the financial result in the Consolidated Statement of Comprehensive Income. Current liabilities include liabilities from bills of exchange amounting to EUR 474 thousand and other liabilities.

iv. Maturity of financial liabilities

The financial liabilities of NORMA Group have the following maturity:

T 101 MATURITY OF FINANCIAL LIABILITIES

Dec 31, 2018

IN EUR THOUSANDS	up to 1 year	> 1 year up to 2 years	> 2 years up to 5 years	> 5 years
Borrowings	113,332	33,348	335,977	86,434
Trade and other payables	142,028	0	0	0
Finance lease liabilities	16	4	12	0
Other financial liabilities	18,850	0	1,976	0
	274,226	33,352	337,965	86,434

Dec 31, 2017

IN EUR THOUSANDS	up to 1 year	> 1 year up to 2 years	> 2 years up to 5 years	> 5 years
Borrowings	33,136	106,612	199,782	148,717
Trade and other payables	145,749	0	0	0
Finance lease liabilities	123	32	1	0
Other financial liabilities	6,184	245	3,946	0
	185,192	106,889	203,729	148,717

v. Net debt

Net debt of NORMA Group is as follows:

T 102 NET DEBT

IN EUR THOUSANDS	Dec 31, 2018	Dec 31, 2017
Bank borrowings, net	569,091	488,247
Derivative financial liabilities – hedge accounting	758	1,419
Finance lease liabilities	32	156
Other financial liabilities	20,826	10,375
Financial debt	590,707	500,197
Cash and cash equivalents	190,392	155,323
Net debt	400,315	344,874

At EUR 590,707 thousand, the financial liabilities of NORMA Group were 18.1% higher than on December 31, 2017 (EUR 500,197 thousand). The increase in loans is attributable to the taking up of the accordion facility of EUR 102,000 thousand agreed to under the syndicated loan agreement to finance acquisitions and refinance a promissory note tranche. Furthermore, the effects of exchange rate changes on the US dollar tranches of the syndicated loans and the promissory note loan increased the loans item. Offsetting effects resulted from the scheduled repayment of the syndicated loans in the amount of EUR 4,805 thousand and the promissory note loans in the amount of EUR 26,000 thousand. In the area of derivatives, there was a decline in the negative market values of the hedging derivatives. The increase in other financial liabilities mainly resulted from an increase in liabilities from ABS and factoring of EUR 16,674 thousand. On the other hand, other liabilities decreased due to the payment of purchase price liabilities in the amount of EUR 2,989 thousand and an adjustment of the recognized liabilities for the option to acquire minority interests in the amount of EUR 1,976 thousand (2017: EUR 2,981 thousand) in connection with the acquisition of Fengfan.

Net debt increased by EUR 55,441 thousand to EUR 400,315 thousand compared to December 31, 2017 (EUR 344,874 thousand), an increase of 16.1%. The main reason for this was the financing of the acquisitions of Kimplas and Statek. In addition, the aforementioned effects from exchange rate changes in the area of loans had an increasing effect on net debt. Countervailing effects resulted from the increase in cash and cash equivalents due to the net inflow of funds from the total cash flow from operating activities, cash outflows from investing activities (excluding payments for acquisitions) and dividend payments.

20. (F) DERIVATIVE FINANCIAL INSTRUMENTS

Derivative financial instruments held for hedging purposes are carried at fair value. They are fully classified in Level 2 of the fair value hierarchy.

The derivative financial instruments are as follows:

T 103 DERIVATIVE FINANCIAL INSTRUMENTS

IN EUR THOUSANDS	Dec 31, 2018		Dec 31, 2017	
	Assets	Liabilities	Assets	Liabilities
Interest rate swaps – cash flow hedges	2,571	675	1,885	1,226
Foreign exchange derivatives – cash flow hedges	151	45	458	43
Foreign exchange derivatives – fair value hedges	42	38	182	150
Total	2,764	758	2,525	1,419
Less non-current portion				
Interest rate swaps – cash flow hedges	2,180	605	1,885	1,226
Non-current portion	2,180	605	1,885	1,226
Current portion	584	153	640	193

Further details on the use of hedging instruments can be found in ► **NOTE 5 'FINANCIAL RISK MANAGEMENT.'**

**i. Effects of accounting for cash flow hedges on the net assets,
financial position and results of operations**

The effects of foreign currency and interest rate-related hedging instruments on the net assets, financial position and results of operations are as follows:

T 104 THE EFFECTS OF CASH FLOW HEDGE ACCOUNTING ON FINANCIAL POSITION AND PERFORMANCE

IN EUR THOUSANDS	Net book value as of Dec 31, 2018 (+ Derivative financial assets/ – Derivative financial liabilities)	Nominal amount (+Buy/–Sell)	Average hedging rate	Hedging ratio ¹	Maturity	Change in fair value of the hedging item since 1 Jan	Change in fair value of the hedged item used as the basis for recognizing hedge ineffectiveness for the period
Currency risk hedging CFH							
Currency forwards EUR – CZK	105	–9,600	26.29	1:1	≤ 1 year	115	– 115
Currency forwards EUR – PLN	17	– 600	4.42	1:1	≤ 1 year	8	– 8
Currency forwards EUR – GBP	30	–6,000	0.90	1:1	≤ 1 year	53	–53
Currency forwards EUR – CNY	–33	2,500	8.05	1:1	≤ 1 year	10	–10

¹The forward foreign exchange contracts are denominated in the same currency as the highly probable future transactions, therefore the hedge ratio is 1:1

IN EUR THOUSANDS	Net book value as of Dec 31, 2018 (+ Derivative financial assets/ – Derivative financial liabilities)	Nominal amount	Average hedging rate	Hedging ratio ¹	Maturity	Change in fair value of the hedging item since 1 Jan	Change in fair value of the hedged item used as the basis for recognizing hedge ineffectiveness for the period	Book value of hedged item as of Dec 31, 2018
Hedging interest rate risk - interest rate swap								
		193,042				1,300	–1,300	193,042
Interest rate swap USD	2,571	126,403	1.57	1:1	2019 – 2021			
Interest rate swap USD	– 70	43,639	0.00	1:1	2021			
Interest rate swap EUR	–605	23,000	1.54	1:1	2020			

106 Consolidated
Statement of
Comprehensive
Income

107 Consolidated
Statement of
Financial Position

108 Consolidated
Statement of
Cash Flows

109 Consolidated
Statement of
Changes in Equity

**110 Notes to the
Consolidated Financial
Statements**

197 Appendix to the Notes
to the Consolidated
Financial Statements

200 Responsibility
Statement

201 Independent
Auditor's Report



106 Consolidated Statement of Comprehensive Income

107 Consolidated Statement of Financial Position

108 Consolidated Statement of Cash Flows

109 Consolidated Statement of Changes in Equity

110 Notes to the Consolidated Financial Statements

197 Appendix to the Notes to the Consolidated Financial Statements

200 Responsibility Statement

201 Independent Auditor's Report

The effective part, as well as the accrued and recognized costs of hedging recognized in other comprehensive income excluding taxes developed as follows:

T 105 CHANGE IN HEDGING RESERVE BEFORE TAX

IN EUR THOUSANDS	Foreign exchange derivatives	Interest rate swaps ¹	Cross-currency swaps	Total
Balance as of January 1, 2017	0	712	-437	275
Foreign currency translation effects		-16	0	-16
Reclassification to profit or loss		-727	1,271	544
Net fair value changes		310	-174	136
Balance as of December 31, 2017	0	279	660	939
Foreign currency translation effects	0	-2	0	-2
Reclassification to profit or loss	0	-279	-63	-342
Net fair value changes	0	59	1,300	1,359
Accrued and recognized costs of hedging	-67	0	0	-67
Balance as of December 31, 2018	-67	57	1,897	1,887

¹ In the fiscal year 2017, the values in this column contain the effective part of the hedging relationship determined in accordance with IAS 39.

Amounts due to interest rate swaps recognized in the hedging reserve in equity will be released in profit or loss before the repayment of the loans. Amounts due to foreign exchange derivatives recognized in the hedging reserve in equity are current and will therefore be released in profit or loss within one year.

In 2018 and 2017, no ineffective portion of cash flow hedges relating to foreign exchange derivatives and interest rate swaps was recognized in profit or loss.

ii. Effects of accounting for fair value hedges on the net assets, financial position and results of operations

The effects of foreign currency-related hedging instruments on the net assets, financial position and results of operations are as follows:

T 106 THE EFFECTS OF FAIR VALUE HEDGE ACCOUNTING ON FINANCIAL POSITION AND PERFORMANCE

IN EUR THOUSANDS	Net book value as of Dec 31, 2018 (+Derivative financial assets/ -Derivative financial liabilities)	Nominal amount (+Buy/-Sell)	Average hedging rate	Hedging ratio	Maturity	Change in fair value of the hedging item since Jan 1	Change in fair value of the hedged item used as the basis for recognizing hedge ineffectiveness for the period
Currency risk hedging FVH							
Currency forwards USD – EUR	-20	-8,734	1.16	1:1 ¹	≤ 1 year	28	-28
Currency forwards GBP – EUR	-10	2,236	0.89	1:1 ²	≤ 1 year	17	-17
Currency forwards SEK – EUR	23	3,413	10.33	1:1 ²	≤ 1 year	25	-25
Currency forwards PLN – EUR	19	3,022	4.36	1:1 ²	≤ 1 year	11	-11
Currency forwards JPY – SGD	-7	556	79.41	1:1 ²	≤ 1 year	4	-4

1_ The foreign exchange forward contracts for USD - EUR hedging are denominated in the same currency and have the same volume as the hedged net foreign exchange risk from external USD loans and intra-group monetary items in USD, therefore the hedge ratio is 1: 1

2_ The forward exchange contracts are denominated in the same currency and volume as the hedged risk from intra-group monetary items, therefore the hedge ratio is 1: 1

An overview of the gains and losses arising from the hedging of fair value changes that were recognized in the financial result is shown below:

T 107 GAINS AND LOSSES FAIR-VALUE HEDGES

IN EUR THOUSANDS	2018	2017
Losses (-)/Gains (+) on hedged items	531	-5,155
Losses (-)/Gains (+) on hedging instruments	-892	4,552
	-361	-603

106	Consolidated Statement of Comprehensive Income
107	Consolidated Statement of Financial Position
108	Consolidated Statement of Cash Flows
109	Consolidated Statement of Changes in Equity
110	Notes to the Consolidated Financial Statements
197	Appendix to the Notes to the Consolidated Financial Statements
200	Responsibility Statement
201	Independent Auditor's Report

20. (G) FINANCIAL INSTRUMENTS AT FAIR VALUE

The tables below provide an overview of the classification of financial assets and liabilities measured at fair value in the fair value hierarchy under IFRS 13 as of December 31, 2018, as well as December 31, 2017:

T 108 FINANCIAL INSTRUMENTS – FAIR VALUE HIERARCHY

IN EUR THOUSANDS	Level 1 ¹	Level 2 ²	Level 3 ³	Total as of Dec 31, 2018
Recurring fair value measurements				
Assets				
Interest rate swaps – cash flow hedges		2,571		2,571
Foreign exchange derivatives – cash flow hedges		151		151
Foreign exchange derivatives – fair value hedges		42		42
Trade receivable – ABS/Factoring program		14,653		14,653
Total	0	17,417	0	17,417
Liabilities				
Interest rate swaps – cash flow hedges		675		675
Foreign exchange derivatives – cash flow hedges		45		45
Foreign exchange derivatives – fair value hedges		38		38
Total	0	758	0	758

IN EUR THOUSANDS	Level 1 ¹	Level 2 ²	Level 3 ³	Total as of Dec 31, 2017
Recurring fair value measurements				
Assets				
Interest rate swaps – cash flow hedges		1,885		1,885
Foreign exchange derivatives – cash flow hedges		458		458
Foreign exchange derivatives – fair value hedges		182		182
Total	0	2,525	0	2,525
Liabilities				
Interest rate swaps – cash flow hedges		1,226		1,226
Foreign exchange derivatives – cash flow hedges		43		43
Foreign exchange derivatives – fair value hedges		150		150
Total	0	1,419	0	1,419

1_Fair value measurement based on quoted prices (unadjusted) in active markets for these or identical assets or liabilities.

2_Fair value measurement for the asset or liability based on inputs that are observable on active markets either directly (i. e. as priced) or indirectly (i. e. derived from prices).

3_Fair value measurement for the asset or liability based on inputs that are not observable market data.

No transfers between the different levels occurred in 2018 and 2017.

The fair value of interest swaps is calculated as the present value of estimated future cash flows. The fair value of forward foreign exchange contracts is determined using a present value model based on forward exchange rates.

Trade receivables held for sale as part of the factoring and ABS transaction and measured at fair value through profit or loss have short-term maturities. In addition, the calculated credit risk of the counterparty is not material, therefore the carrying amounts at the balance sheet date correspond to their fair values.

20. (H) NET GAINS AND LOSSES ON FINANCIAL INSTRUMENTS

The net gains or losses on financial instruments (by measurement category) in accordance with IFRS 7.20 (a) are as follows:

T 109 FINANCIAL INSTRUMENTS – NET GAINS AND LOSSES

IN EUR THOUSANDS	2018	2017
Net gains or net losses on financial assets		
measured at amortized cost (2017: LaR)	191	- 160
Net gains or net losses on financial liabilities		
measured at amortized cost	- 11,481	- 13,834
	- 11,290	- 13,994

Net gains and losses on financial assets measured at amortized cost include impairment losses on trade receivables and interest income from short-term deposits with banks. Net gains and losses on financial liabilities measured at cost include interest expense and fees from loans and borrowings.

Currency effects from the translation of financial assets and liabilities according to IAS 21 are shown within ► **NOTE 14 'NET FOREIGN EXCHANGE GAINS/LOSSES.'**

20. (I) TOTAL INTEREST INCOME AND EXPENSE FROM FINANCIAL INSTRUMENTS

T 110 INTEREST EXPENSES/INCOME FROM FINANCIAL ASSETS AND LIABILITIES (IFRS 7.20(B))

IN EUR THOUSANDS	2018	2017
Interest income		
financial assets at cost	484	396
Interest expenses		
financial liabilities at cost	- 13,578	- 12,705

Interest expense on financial liabilities carried at amortized cost in fiscal year 2018 includes EUR 13,344 thousand in interest expenses for loans (2017: EUR 12,437 thousand) and EUR 62 thousand in interest income from hedging derivatives (2017: interest expense of EUR 1,271 thousand).

21. INVENTORIES

Inventories were as follows:

T 111 INVENTORIES

IN EUR THOUSANDS	Dec 31, 2018	Dec 31, 2017
Raw materials, consumables and supplies	48,220	38,252
Work in progress	20,978	16,395
Finished goods and goods for resale	108,909	96,582
	178,107	151,229

On December 31, 2018, impairments were made on inventories amounting to EUR 6,561 thousand (Dec 31, 2017: EUR 4,385 thousand).

Inventories include inventories amounting to EUR 5,486 thousand from Kimplas and Statek, the entities acquired in 2018.

On December 31, 2018, and 2017, the inventories were not collateralized with the exception of the customary business reservations of title.

106 Consolidated
 Statement of
 Comprehensive
 Income

107 Consolidated
 Statement of
 Financial Position

108 Consolidated
 Statement of
 Cash Flows

109 Consolidated
 Statement of
 Changes in Equity

**110 Notes to the
 Consolidated Financial
 Statements**

197 Appendix to the Notes
 to the Consolidated
 Financial Statements

200 Responsibility
 Statement

201 Independent
 Auditor's Report

22. OTHER NON-FINANCIAL ASSETS

Other non-financial assets were as follows:

T 112 OTHER NON-FINANCIAL ASSETS		
IN EUR THOUSANDS	Dec 31, 2018	Dec 31, 2017
Deferred costs	3,679	3,854
VAT assets	8,237	9,022
Prepayments	4,289	3,174
Consideration payable to a customer	2,933	0
Other assets	1,250	752
	20,388	16,802

106 Consolidated
Statement of
Comprehensive
Income107 Consolidated
Statement of
Financial Position108 Consolidated
Statement of
Cash Flows109 Consolidated
Statement of
Changes in Equity**110 Notes to the
Consolidated Financial
Statements**197 Appendix to the Notes
to the Consolidated
Financial Statements200 Responsibility
Statement201 Independent
Auditor's Report**23. EQUITY****SUBSCRIBED CAPITAL**

The subscribed capital of the Company on December 31, 2018, and 2017 amounted to EUR 31,862 thousand and was fully paid in. It is divided into 31,862,400 shares with no par value and a notional value of EUR 1. The liability of the shareholders for the obligations of the Company to its creditors is limited to this capital. The amount of the subscribed capital is not permitted to be distributed by the Company to its shareholders.

AUTHORIZED AND CONDITIONAL CAPITAL

The Management Board is entitled to increase the share capital by up to EUR 12,744,960.00 until May 19, 2020, by issuing up to 12,744,960 new no-par value registered shares in exchange for cash and/or contributions in kind either once or several times by resolution of the Annual General Meeting held on May 20, 2015, with the approval of the Supervisory Board, whereby the subscription rights of shareholders may be restricted (Authorized Capital 2015).

The share capital is being increased by up to EUR 3,186,240.00 by resolution of the Annual General Meeting on May 20, 2015, by issuing up to 3,186,240 new no-par value registered shares to grant convertible bonds and/or bonds with warrants (Conditional Capital 2015).

The resolutions of the Annual General Meeting of April 6, 2011, Authorized Capital 2011 and Conditional Capital 2011, were repealed.

CAPITAL RESERVE

The capital reserve contains:

- ▶ amounts (premiums) received for the issuance of shares,
- ▶ premiums paid by shareholders in exchange for the granting of a preference for their shares,
- ▶ amounts resulting from other capital contributions of the owners.

RETAINED EARNINGS

Retained earnings consisted of the following:

T 113 DEVELOPMENT OF RETAINED EARNINGS

IN EUR THOUSANDS	Retained earnings	Remeasurements of post-employment benefit obligations	IPO costs directly netted with equity	Reimbursement of IPO costs by shareholders	Acquisition of non-controlling interest	Effects from the application of IAS 19R	Effects of IFRS 9	Total
Balance as of December 31, 2016	217,228	-2,175	-4,640	4,681	-2,429	839	0	213,504
Profit for the year	119,664							119,664
Dividends paid	-30,269							-30,269
Acquisition of non-controlling interests					-4,501			-4,501
Effect before taxes		-458						-458
Tax effect		137						137
Balance as of December 31, 2017 (as reported)	306,623	-2,496	-4,640	4,681	-6,930	839	0	298,077
Balance as of Jan 1, 2018	306,623	-2,496	-4,640	4,681	-6,930	839	-600	297,477
Profit for the year	91,873							91,873
Dividends paid	-33,456							-33,456
Acquisition of non-controlling interests					342			342
Effect before taxes		-265						-265
Tax effect		51						51
Balance as of December 31, 2018	365,040	-2,710	-4,640	4,681	-6,588	839	-600	356,022

A dividend of EUR 33,456 thousand (EUR 1.05 per share) was paid to the shareholders of NORMA Group after the Annual General Meeting in May 2018, which reduced the retained earnings. Furthermore, an option to acquire the outstanding non-controlling interests of 10% for Groen Bevestigingsmaterialen B.V. was exercised in fiscal year 2018. EUR 1,121 thousand were paid in cash for the acquisition of the non-controlling interests, against an existing liability. On the ex-

ecution date, existing non-controlling interests in the amount of EUR 342 thousand were reclassified within equity from 'non-controlling interest' to 'retained earnings.'

OTHER RESERVES

Other reserves consisted of the following:

T 114 DEVELOPMENT OF OTHER RESERVES

IN EUR THOUSANDS	Cash flow hedges	Foreign exchange rate differences on translating foreign operations	Total
Balance as of January 1, 2017	268	26,809	27,077
Effect before taxes	664	- 35,830	- 35,166
Tax effect	- 275		- 275
Balance as of December 31, 2017	657	- 9,021	- 8,364
Effect before taxes	948	10,200	11,148
Tax effect	- 267		- 267
Balance as of December 31, 2018	1,338	1,179	2,517

24. SHARE-BASED PAYMENTS

MANAGEMENT INCENTIVE SCHEMES

The Matching Stock Program

The Matching Stock Program (MSP) for the Management Board provides a long-term incentive to commit to the success of the Group. The MSP is a share-based option. To this end, the Supervisory Board specifies a number of share options to be granted each fiscal year with the proviso that the Management Board member make a corresponding personal investment in the Group. In line with the new Management Board contracts, the MSP was closed. The last allotment of options was in fiscal year 2017.

The shares involved in the share options are those shares allocated or acquired and qualified as part of the MSP defined in the Management Board contract. The number of share options is calculated by multiplying the qualified shares (2017: 85,953; 2016: 85,953) held at the time of allotment by the option factor specified by the Supervisory Board. A new option factor is set for every tranche (the option factor for 2017 is 1.5; 2016: 1.5). The first tranche was allocated on the day of the IPO. The other tranches will be allocated on March 31 each following year. There are therefore 128,929 share options in the 2017 fiscal year (2016: 128,929 share options). The holding period is four years (on March 31, 2021, for the 2017 tranche, on March 31, 2020, for the 2016 tranche and on March 31, 2019, for the

2015 tranche. Non-forfeitable claims out of the options are earned pro rata over the respective performance period. The exercise price for the outstanding tranches will be the weighted average of the respective closing price of the Group's share on the 60 trading days directly preceding the allocation of each tranche. Dividend payments by the Group during the vesting period are deducted from the exercise price of each tranche.

The options of a tranche can only be exercised within a period of two years following the expiration of the holding period. In order for an option to be exercised, the weighted average of the last ten trading days must be at least 1.2 times that of the exercise price. The pay-out is limited to 2% of the average (adjusted) EBITA (tranches 2014, 2015, 2016 and 2017) or to 2% of the average (adjusted) EBITDA (tranche 2013) during the holding period (cap). When the option is exercised, the Group can decide whether to settle the option in shares or cash.

In the second quarter of 2015, the MSP for the Management Board of NORMA Group was switched over to cash settlement by resolution of the Supervisory Board. Due to the change in classification of the stock options from being a settlement in equity instruments to a cash settlement, the proportional fair value of the options was recalculated at the time of the change in estimates. The proportional expenses for the year 2015 up to the date of change in the amount of EUR 135 thousand were recognized within the capital reserve through profit or loss. The pro rata fair value on the date of the change in the assessment in the amount of EUR 6,278 thousand was recognized directly in equity as a reduction of the capital reserve against a corresponding provision.

T 115 DEVELOPMENT OF THE MSP OPTION RIGHTS

	Tranche MSP 2014	Tranche MSP 2015	Tranche MSP 2016	Tranche MSP 2017
Expected duration until exercise in years	n/a	0.42	1.42	2.42
Proportional fair value per outstanding "share units" in EUR as of December 31, 2018	n/a	267,484.00	327,913.00	352,567.00
Fair value per "share unit" in EUR as of December 31, 2018	n/a	2.75	4.39	6.83
Exercise price in EUR	36.86	41.19	43.72	39.60
Balance as of December 31, 2016	137,366	128,929	128,929	0
Tentatively granted "share units"				128,929
Exercised				
Lapsed	17,187	31,607	54,464	77,322
Balance as of December 31, 2017	120,179	97,322	74,465	51,607
Balance as of December 31, 2017	120,179	97,322	74,465	51,607
Tentatively granted "share units"				
Exercised	120,179			
Lapsed				
Balance as of December 31, 2018	0	97,322	74,465	51,607

In fiscal year 2018, income in the amount of EUR 526 thousand (2017: expenses of EUR 3,212 thousand) resulting from the MSP were recognized in employee benefits expense against a corresponding net reversal within the provisions. Furthermore, a payment amounting to EUR 2,468 was made for the exercised options of the 2014 tranche (2017: tranche 2013 EUR 3,004 thousand).

The total provision for the MSP amounts to EUR 948 thousand as of December 31, 2018 (Dec 31, 2017: EUR 3,858 thousand).

The determination of fair value, which is the basis for determining the pro rata provision on the balance sheet date, was carried out using a Monte Carlo method. The expected volatilities are set to be the historical volatility of the three-year period before the valuation date. Due to the cash settlement, the options are valued on each balance sheet date and the resulting changes in fair value are recognized through profit or loss, whereby the prorated expenses were ratably recognized over the performance period.

The option rights granted under the MSP changed as follows in the 2018 and 2017 fiscal years:

LONG-TERM INCENTIVE PLAN

In fiscal year 2013, NORMA Group installed a share-based, long-term, variable compensation component for executives and certain other groups of employees (Long-Term Incentive Plan).

The Long-Term Incentive Plan (LTI) is a share-based payment, cash settled plan that takes into account both the performance of the Company and the share price development.

106 Consolidated Statement of Comprehensive Income

107 Consolidated Statement of Financial Position

108 Consolidated Statement of Cash Flows

109 Consolidated Statement of Changes in Equity

110 Notes to the Consolidated Financial Statements

197 Appendix to the Notes to the Consolidated Financial Statements

200 Responsibility Statement

201 Independent Auditor's Report

The participants receive a preliminary number of share units (virtual shares) at the start of the performance period based on a percentage of the respective base salary multiplied by a conversion rate. The conversion rate is determined based on the average share price of the previous 60 trading days of the calendar year prior to the grant date. Once four years have elapsed, the number of share units granted at the start of the performance period is adjusted based on the performance the Company has achieved, incorporating both the targets defined during the performance period and the Company/regional factor.

The goal achievement factor, measured by adjusted EBITA, as well as the Company/regional factor are applied as performance targets. The goal achievement factor is based on the adjusted EBITA of NORMA Group. The absolute adjusted EBITA target is determined for every year of the performance period based on the budgeted value. After conclusion of the four-year period, the yearly recorded adjusted EBITA values are defined as a percentage in relation to the target values and averaged out over the four years. Allocation occurs above a goal achievement ratio of 90%. Between 90% and 100% goal achievement, every percentage point amounts to 10 percentage points of goal achievement factor. Between 100% and 200% goal achievement, the goal achievement factor grows by 1.5 percentage points per percentage point of goal achievement.

The Company factor is determined by the Group Senior Management based on the Company's development, as well as the development in relation to comparable companies. In addition to this, the development of free cash flows is taken into account when determining the factor. At the discretion of the Group Senior Management, unanticipated developments can also be taken into account and the Company factor corrected either downward or upward accordingly. The factor can assume values between 0.5 and 1.5.

The regional factor is defined by the Group Senior Management prior to pay-out and can assume a value between 0.5 and 1.5. The factor takes into account the results of the region, as well as any region-specific aspects.

The value of the share units is then determined at the end of the fourth calendar year based on the average share price of the last 60 days of trading in this fourth year. In case the calculated Long-term Incentive pay-out exceeds 250% of the initial grant value, the maximum pay-out is capped at 250%. The value determined is paid out to the participants in cash in May of the fifth year.

The LTI is a Group-wide and global compensation instrument with a long-term orientation. Due to the coupling to the development not only of the stock price, but also the Company's performance, the LTI provides an additional incentive to create value through value-based action, aligned with the goals of NORMA Group.

The determination of fair value, which is the basis for determining the pro rata provision on the balance sheet date, was performed using a Monte Carlo simulation. Due to the cash settlement of the virtual share units, the fair value is measured on each balance sheet date and the resulting changes in the fair value are recognized in income or loss. The allocation of the expenses is made on a pro rated basis over the performance period.

The share units granted under the LTI changed as follows in the 2018 and 2017 fiscal years:

T 116 DEVELOPMENT OF LTI

	2 nd Tranche LTI 2014	3 rd Tranche LTI 2015	4 th Tranche LTI 2016	5 th Tranche LTI 2017	6 th Tranche LTI 2018
Expected duration until exercise in years	n/a	n/a	1.00	2.00	3.00
Fair value per "share unit" in EUR as of December 31, 2018	n/a	48.25	42.47	41.47	40.70
Share price when granted in EUR	36.40	36.89	48.57	39.77	56.27
Balance as of December 31, 2017	18,567	31,029	27,394	41,184	0
Tentatively granted "share units"	-	-	-	-	29,259
Exercised	18,567	-	-	-	-
Lapsed	-	99	7,194	3,553	451
Balance as of December 31, 2018	0	30,930	20,200	37,631	28,808
	2 nd Tranche LTI 2014	3 rd Tranche LTI 2015	4 th Tranche LTI 2016	5 th Tranche LTI 2017	
Expected duration until exercise in years	n/a	1.00	2.00	3.00	
Fair value per "share unit" in EUR as of December 31, 2017	56.27	54.96	53.81	51.75	
Share price when granted in EUR	36.40	36.89	48.57	39.77	
Balance as of December 31, 2016	18,567	32,995	31,210	0	
Tentatively granted "share units"	-	-	0	41,184	
Exercised	-	1,966	265	-	
Lapsed	-	-	3,551	-	
Balance as of December 31, 2017	18,567	31,029	27,394	41,184	

In fiscal year 2018, expenses resulting from the LTI in the amount of EUR 360 thousand (2017: EUR 953 thousand) were recorded under personnel expense and within a corresponding provision. Furthermore, a payment amounting to EUR 1,045 (2017: tranche 2013: EUR 947 thousand) was made for exercised options (tranche 2014).

In total, the provision for the LTI amounts to EUR 2,982 thousand as of December 31, 2018 (Dec 31, 2017: EUR 3,667 thousand).

25. RETIREMENT BENEFIT OBLIGATIONS

Retirement benefit obligations result mainly from two German pension plans and a Swiss post-employment benefit plan.

The German defined benefit pension plan for NORMA Group employees was closed for new entrants in 1990 and provides benefits in case of retirement, disability, and death as life-long pension payments. The benefit entitlements depend on years of service and salary. The portion of salary that is above the income threshold for social security contribution leads to higher benefit entitlements compared to the portion of the salary up to that threshold. Although the plan was closed in 1990, NORMA Group is still exposed to certain actuarial risks associated with defined benefit plans, such as longevity and compensation increases. Due to the amount of the obligation and the composition of the plan participants, approximately 95% being pensioners, a significant change in the actuarial assumptions would have no significant effects on NORMA Group.

Employees hired after 1990 are eligible under a defined contribution scheme. The contributions are paid into an insurance contract providing lump sum payments in case of retirements and deaths.

Furthermore, a plan for members of the Management Board was established in fiscal year 2015. This second German defined benefit plan is based on a direct commitment to an annual retirement payment for members of the Management Board of NORMA Group. The annual retirement payment is measured as a percentage of the pensionable income. The pension entitlement arises when the contract has expired, but not before reaching the age of 65, or if that individual is unable to work. The percentage depends on the number of years of service as a Management Board member. The percentage amounts to 4% of the last fixed annual salary prior to leaving for each completed year of service. The percentage can increase to a maximum of 55%. Furthermore, a survivor's pension is to be provided as well.

106 Consolidated Statement of Comprehensive Income

107 Consolidated Statement of Financial Position

108 Consolidated Statement of Cash Flows

109 Consolidated Statement of Changes in Equity

110 Notes to the Consolidated Financial Statements

197 Appendix to the Notes to the Consolidated Financial Statements

200 Responsibility Statement

201 Independent Auditor's Report

The obligations arising from the plan are subject to certain actuarial risks associated with defined benefit plans, such as longevity and compensation increases. Please see the Remuneration Report for further details with regard to this plan. ► **REMUNERATION REPORT, P. 91**

Besides the German plans, there is a further benefit plan in Switzerland resulting from the Swiss 'Berufliches Vorsorgegesetz' law (BVG). According to the BVG, each employer has to grant post-employment benefits for qualifying employees. The plan is a capital-based plan under which the Company has to make contributions equivalent to at least the limits specified in the plan conditions for employee contributions. These plans are administered by foundations that are legally separated from the entity and subject to the BVG. The Group has outsourced the investment process to a foundation, which sets the strategic asset allocation in its group life portfolio. All regulatory granted obligations out of the plan are reinsured by an insurance company. This covers risks of disability, death and longevity. Furthermore, there is a 100% capital and interest guarantee for the retirement assets invested. In the case of a shortfall, the employer and plan participants' contribution may be increased based on the decisions of the relevant foundation board. Strategies of the foundation boards to make up for potential shortfalls are subject to approval by the regulator.

Besides the plans described in Germany and Switzerland, NORMA Group also participates in a multi-employer pension plan in the US for the benefit of employees of one of its US-based plants. NORMA Group's obligation to participate in the fund arises from the agreement with the employees' labor organization. The multi-employer pension plan is governed by US federal law under which the plan funds are held in trust and the plan administration and procedures substantially governed by federal regulation. The multi-employer pension plan is a defined benefit plan, and would normally be treated as such based on its associated actuarial estimates; however, the plan trustees do not provide the participating employers with sufficient information to individually account for the plan (or their portioned participation therein) as a defined benefit plan. For this reason, the plan is being treated in accordance with the rules for defined contribution pension plans (IAS 19.34). The share of contributions that NORMA Group paid to the pension schemes in the previous fiscal year amounts to EUR 1.3 million (2017: EUR 1.2 million). Contributions to the plan are recognized directly in personnel expenses for the period. Future changes to the contributions, if any, would be determined through negotiations with the workers' organization, as they may be slightly modified from time to time by regulation, and except for which NORMA Group has no other fixed commitment to the plan. Conditionally, in the unlikely event that NORMA Group withdraws from the fund or a significant employer in the fund experiences a major solvency event, additional future contribution payment obligations could arise. The funded status of the multi-em-

ployer plan is reported annually by the US Department of Labor, and is influenced by various factors, including investment performance, inflation, changes in demographics and changes in the participants' levels of performance. Based on the information provided by the plan administrator, the plan is undercapitalized. The value of the undercapitalization amounts to USD 1,127.4 million for all plan participants (over 150 companies). The portion of NORMA Group to this shortfall is 3.0% (based on information provided for 2017). The expected employer contributions to the pension schemes for the following year 2019 amount to EUR 1,145 thousand.

RECONCILIATION OF DEFINED BENEFIT OBLIGATIONS (DBO) AND PLAN ASSETS

The amounts included in the Group's Consolidated Financial Statements arising from its post-employment defined benefit plans are as follows:

T 117 COMPONENTS PENSION LIABILITY

IN EUR THOUSANDS	Dec 31, 2018	Dec 31, 2017
Present value of obligations	17,786	15,537
Fair value of plan assets	4,982	3,410
Liability in the balance sheet	12,804	12,127

The reconciliation of the net defined benefit liability (liability in the balance sheet) is as follows:

T 118 RECONCILIATION OF THE NET DEFINED BENEFIT LIABILITY

IN EUR THOUSANDS	2018	2017
As of January 1	12,127	11,786
Current service cost	1,189	747
Past service cost	0	0
Administration costs	16	16
Interest expenses	124	124
Remeasurements:		
Return on plan assets excluding amounts included in net interest expenses	-94	-78
Actuarial (gains) losses from changes in demographic assumptions	-29	51
Actuarial (gains) losses from changes in financial assumptions	120	56
Experience (gains) losses	268	429
Employer contributions	-224	-211
Benefits paid	-836	-646
Settlement payments	0	0
Business combinations, disposals and other	98	-53
Foreign currency translation effects	45	-94
As of December 31	12,804	12,127

A detailed reconciliation of the changes in the DBO is provided in the following table:

T 119 RECONCILIATION OF THE CHANGES IN THE DBO

IN EUR THOUSANDS	2018	2017
As of January 1	15,537	14,805
Current service cost	1,189	747
Past service cost	0	0
Administration costs	16	16
Interest expenses	157	146
Remeasurements:		
Actuarial (gains) losses from changes in demographic assumptions	-29	51
Actuarial (gains) losses from changes in financial assumptions	120	56
Experience (gains) losses	268	429
Plan participants contribution	120	731
Benefits paid	-865	-646
Transfers	-86	-383
Settlement payments	0	0
Business combinations, disposals and other	1,174	-53
Foreign currency translation effects	185	-362
As of December 31	17,786	15,537

The total defined benefit obligation at the end of fiscal year 2018 includes EUR 9,589 thousand for active employees, EUR 203 thousand for former employees with vested benefits and EUR 7,994 thousand for retirees and surviving dependents.

The transfer in the amount of EUR 86 thousand (2017: EUR 383 thousand) relates to the benefit plan in Switzerland and is a result of the legally required transfer of net defined benefit obligation to the new employer upon the departure of an employee.

Experience gains and losses recognized in fiscal year 2018 are also a result of the described transfers within the benefit plan in Switzerland and a result of changes in the number of participants within the plan in Germany.

A detailed reconciliation of the changes in the fair value of plan assets is provided in the following table

T 120 RECONCILIATION OF CHANGES IN THE FAIR VALUE OF PLAN ASSETS

IN EUR THOUSANDS	2018	2017
As of January 1	3,410	3,019
Interest income	33	22
Remeasurements:		
Return on plan assets excluding amounts included in net interest expenses	94	78
Employer contributions	224	211
Plan participants contributions	120	731
Benefits paid	-29	0
Transfers	-86	-383
Business combinations, disposals and other	1,076	0
Foreign currency translation effects	140	-268
Fair value of plan assets at end of year	4,982	3,410

DISAGGREGATION OF PLAN ASSETS

The allocation of the plan assets of the benefit plans is as follows:

T 121 DISAGGREGATION OF PLAN ASSETS

IN EUR THOUSANDS	2018	2017
Asset class		
Insurance contracts	4,937	3,357
Cash deposit	38	47
Equity securities	7	6
Total	4,982	3,410

Cash deposits and equity securities have quoted prices in active markets. The values for insurance contracts represent the redemption value. No quoted prices in an active market are available for these.

ACTUARIAL ASSUMPTIONS

The principal actuarial assumptions are as follows:

T 122 ACTUARIAL ASSUMPTIONS

IN %	2018	2017
Discount rate	1.13	1.11
Inflation rate	1.51	1.55
Future salary increases	2.28	2.30
Future pension increases	1.59	1.62

The biometric assumptions are based on the 2018 G Heubeck life-expectancy tables for the German plan and on the life-expectancy tables of the BVG 2015 G for the Swiss plan. The tables are generation tables and hence differ according to gender, status and year of birth.

SENSITIVITY ANALYSIS

If the discount rate were to differ by +0.25%/-0.25% from the interest rate used on the balance sheet date, the defined benefit obligation for pension benefits would be an estimated EUR 425 thousand lower or EUR 463 thousand higher. If the future pension increase used were to differ by +0.25%/-0.25% from Management's estimates, the defined benefit obligation for pension benefits would be an estimated EUR 181 thousand higher or EUR 176 thousand lower. The reduction/increase in the mortality rates by 10% results in an increase/deduction in life expectancy depending on the individual age of each beneficiary. That means, for example, that the life expectancy of a male NORMA Group employee age 55 years as of December 31, 2018, increases/decreases by approximately one year. In order to determine the longevity sensitivity, the mortality rates were reduced/increased by 10% for all beneficiaries. The effect on DBO as of December 31, 2018, due to a 10% reduction/increase in mortality rates would result in an increase of EUR 734 thousand or a decrease of EUR 738 thousand.

When calculating the sensitivity of the defined benefit obligation to significant actuarial assumptions, the same method (present value of the defined benefit obligation calculated with the projected unit credit method) has been applied as when calculating the post-employment benefit obligation recognized in the Consolidated Statement of Financial Position. Increases and decreases in the discount rate or rate of pension progression which are used in determining the DBO do not have a symmetrical effect on the DBO due to the compound interest effect created when determining the net present value of the future benefit. If more than one of the assumptions are changed simultaneously, the combined impact due to the changes would not necessarily be the same as the sum of the

106 Consolidated Statement of Comprehensive Income

107 Consolidated Statement of Financial Position

108 Consolidated Statement of Cash Flows

109 Consolidated Statement of Changes in Equity

110 Notes to the Consolidated Financial Statements

197 Appendix to the Notes to the Consolidated Financial Statements

200 Responsibility Statement

201 Independent Auditor's Report

individual effects due to the changes. If the assumptions change at a different level, the effect on the DBO is not necessarily in a linear relation.

FUTURE CASH FLOWS

Employer contributions expected to be paid to the post-employment defined benefit plans in fiscal year 2019 are EUR 240 thousand (2018: EUR 209 thousand).

Expected payments from post-employment benefit plans are as follows:

T 123 EXPECTED PAYMENTS FROM POST-EMPLOYMENT BENEFIT PLANS

IN EUR THOUSANDS		2018
Expected benefit payments		
2019		836
2020		1,074
2021		827
2022		834
2023		960
2024 – 2028		4,674

IN EUR THOUSANDS		2017
Expected benefit payments		
2018		834
2019		741
2020		962
2021		714
2022		723
2023 – 2027		3,860

The weighted average duration of the defined benefit obligation is 12.0 years (2017: 11.5 years).

26. PROVISIONS

The development of provisions is as follows:

T 124 DEVELOPMENT OF PROVISIONS

IN EUR THOUSANDS	As of Jan 1, 2018	Additions	Amounts used	Unused amounts reversed	Interest accrued	Changes in consolidation	Transfers	Foreign currency translation	As of Dec 31, 2018
Guarantees	1,128	690	-156	-161	0	51	0	8	1,560
Severance	408	56	-368	-98	0	0	24	3	25
Early retirement	3,075	743	-1,405	0	0	0	-1	0	2,412
Other personnel-related obligations	12,164	3,302	-5,541	-234	-8	0	-5	25	9,703
Outstanding invoices	730	1,000	-747	-3	0	0	0	32	1,012
Others	1,279	705	-513	-120	0	34	-74	-13	1,298
Total provisions	18,784	6,496	-8,730	-616	-8	85	-55	55	16,010

IN EUR THOUSANDS	As of Jan 1, 2017	Additions	Amounts used	Unused amounts reversed	Interest accrued	Changes in consolidation	Transfers	Foreign currency translation	As of Dec 31, 2017
Guarantees	1,207	316	-216	-176	0	0	0	-3	1,128
Severance	622	360	-437	-112	0	0	0	-25	408
Early retirement	3,339	1,562	-1,859	0	33	0	0	0	3,075
Other personnel-related obligations	11,999	5,592	-5,124	-543	0	225	244	-229	12,164
Outstanding invoices	780	816	-781	-2	0	0	0	-83	730
Others	1,210	1,133	-763	-231	0	0	-24	-46	1,279
Total provisions	19,157	9,779	-9,180	-1,064	33	225	220	-386	18,784

106 Consolidated
Statement of
Comprehensive
Income107 Consolidated
Statement of
Financial Position108 Consolidated
Statement of
Cash Flows109 Consolidated
Statement of
Changes in Equity**110 Notes to the
Consolidated Financial
Statements**197 Appendix to the Notes
to the Consolidated
Financial Statements200 Responsibility
Statement201 Independent
Auditor's Report**T 125 PROVISIONS – SPLIT CURRENT/NON-CURRENT**

IN EUR THOUSANDS	Dec 31, 2018			Dec 31, 2017		
	Total	thereof current	thereof non-current	Total	thereof current	thereof non-current
Guarantees	1,560	1,363	197	1,128	934	194
Severance	25	25	0	408	408	0
Early retirement	2,412	0	2,412	3,075	0	3,075
Other personnel-related obligations	9,703	5,500	4,203	12,164	5,549	6,615
Outstanding invoices	1,012	1,012	0	730	730	0
Others	1,298	850	448	1,279	924	355
Total provisions	16,010	8,750	7,260	18,784	8,545	10,239

EARLY RETIREMENT CONTRACTS

Employees at NORMA Group in Germany can in general engage in an early retirement contract ('Altersteilzeit'). In the first phase, the employee works 100% ('Arbeitsphase'). In the second phase, he/she is exempt from work ('Freistellungsphase'). The employees receive half of their pay for the total early retirement-phase as well as top-up payments (including social security costs paid by the employer). The duration of the early retirement is a maximum of six years.

Accounting for early retirement ('Altersteilzeit') is based on actuarial valuations taking into consideration assumptions such as a discount rate of 0.02% p.a. (2017: -0.12% p.a.) as well as the 2018 G Heubeck life-expectancy tables. For signed early retirement contracts, a liability has been recognized. The liability includes top-up payments ('Aufstockungsbeträge') as well as deferred salary payments ('Erfüllungsrückstände'). The expected payments out of the early retirement provisions amount to EUR 874 thousand for fiscal year 2019.

GUARANTEES

Provisions for guarantees include provisions due to circumstances where a final agreement has not yet been reached and provisions based on experience (customer claim quota, amount of damage, etc.). Future price increases are considered if material.

SEVERANCE PAYMENTS

Provisions for severance payments include expected severance payments for NORMA Group employees due to circumstances where a final agreement has not yet been reached. The provisions will be paid out in the following fiscal year and are therefore reported under current provisions.

OTHER PERSONNEL-RELATED PROVISIONS

Other personnel-related provisions are as follows:

T 126 PROVISIONS – OTHER PERSONNEL-RELATED

IN EUR THOUSANDS	Notes	Dec 31, 2018			Dec 31, 2017		
		Total	thereof current	thereof non-current	Total	thereof current	thereof non-current
LTI - Board Members		706	617	89	1,428	791	637
LTI - Management	(24)	2,982	852	2,130	3,667	899	2,768
STI - Board Members		1,706	1,706	0	856	856	0
Matching Stock Program (MSP)	(24)	948	268	680	3,858	1,746	2,112
NORMA-VA-Bonus		1,256	1,256	0	314	314	0
Anniversary provisions		1,098	0	1,098	839	0	839
Other personnel-related		1,007	801	206	1,202	943	259
		9,703	5,500	4,203	12,164	5,549	6,615

The Company's Long-Term Incentive Plan (LTI) for the Management Board consists of two different long-term compensation elements. The variable compensation is designed differently depending on the time when a Board member took office. For the Board members in office before 2015, it consists of an EBITA component and an operating free cash flow before external use (FCF) component, each of which is observed over a period of three years (performance period). A new three-year performance period begins every year. Both components are calculated by multiplying the average annual adjusted EBITA and FCF values actually achieved in the performance period by the adjusted EBITA and FCF bonus percentages specified in the employment contract. In the second step, the actual value of a component is compared to the medium-term plan approved by the Supervisory Board to evaluate the Company's performance and adjustments are made to the LTI plan. The LTI plan is limited to two and a half times the amount that would be arrived at on the basis of the figures in the Company's medium-term plan. If the actual value is lower than the planned value, the LTI plan is reduced on a straight-line basis down to a minimum of EUR 0 if the three-year targets are missed by a significant amount. Due to the calculation of the variable remuneration based on future results of the Group, uncertainties exist regarding the amount of the future outflows. Parts of the long-term compensation component will be paid out in the first half of the following fiscal year and are therefore reported under the current provisions.

When entering service as of reporting year 2015, the variable compensation of the Management Board consists of the NORMA VA Bonus. This variable remuneration for the members of the Management Board who are not part of the MSP provides a long-term incentive for the Management Board to work hard to make the Company successful. The LTI is an appreciation bonus that is based on the Group's performance. The Board member receives a percentage of the calculated increase in value. The NORMA Value Added Bonus corresponds to the percentage of the average increase in value from the current and the two previous fiscal years. The annual increase in value is calculated using the following formula:

$$\text{NORMA Value Added} = (\text{adjusted EBIT} \times (1 - t)) - (\text{WACC} \times \text{invested capital})$$

The calculation of the first component is based on the consolidated earnings before interest and taxes (Group EBIT) for the fiscal year and the average corporate tax rate (t). The second component is calculated from the Group cost of capital (WACC) multiplied by the capital invested. The NORMA Value Added Bonus is limited to a fixed annual salary. 75% of the amount attributable to the LTI is paid to each Management Board member the following year. The Company then uses the remaining 25% attributable to the LTI to purchase shares of NORMA Group SE in the name and on behalf of the individual Board members. Alternatively, the Company may pay out this balance to the Board member. In this case, the Management Board obligates itself to purchase shares of NORMA Group SE with the balance of this amount within 120 days after the annual financial statements are approved at the Supervisory Board meeting. The Management Board

106	Consolidated Statement of Comprehensive Income
107	Consolidated Statement of Financial Position
108	Consolidated Statement of Cash Flows
109	Consolidated Statement of Changes in Equity
110	Notes to the Consolidated Financial Statements
197	Appendix to the Notes to the Consolidated Financial Statements
200	Responsibility Statement
201	Independent Auditor's Report

106	Consolidated Statement of Comprehensive Income
107	Consolidated Statement of Financial Position
108	Consolidated Statement of Cash Flows
109	Consolidated Statement of Changes in Equity
110	Notes to the Consolidated Financial Statements
197	Appendix to the Notes to the Consolidated Financial Statements
200	Responsibility Statement
201	Independent Auditor's Report

member may not dispose of the shares for four years. Dividends and subscription rights are to be made freely available to the Management Board member. If a Board member takes office in the current fiscal year or does not work for the Company for a full twelve months in a fiscal year, the LTI is to be reduced proportionally (pro rata). Upon termination of the employment contract, a Management Board member may dispose of his shares only after 12 months of leaving the Company. With the termination of the executive position upon request of the Management Board or on the basis of an important reason, future claims for the variable part of the LTI lapse.

The LTI for Management (Long-Term Incentive Plan) is a variable compensation component based on the share price of NORMA Group. A detailed description can be found in ► **NOTE 24 'SHARE-BASED PAYMENTS.'**

The STI of the Management Board (Short-Term Incentive Plan) results from short term variable cash payment. A description can be found in the ► **REMUNERATION REPORT, P. 91.**

As of December 31, 2018, provisions for the Matching Stock Program (MSP) for NORMA Group's Management Board amount to EUR 948 thousand (2017: EUR 3,858 thousand). In fiscal year 2018, EUR 2,468 thousand were paid for exercised options from the 2014 tranche. ► **NOTE 24 'SHARE-BASED PAYMENTS'**

Anniversary provisions are based on actuarial valuations taking into account assumptions such as a discount rate of 1.37% p. a. as well as the 2018 G Heubeck life-expectancy tables.

Other personnel-related provisions mainly include payable income tax and social security contributions in foreign countries.

Other non-personnel-related provisions

Provisions for outstanding invoices in the amount of EUR 1,012 thousand (2017: EUR 730 thousand) include expected obligations for the audit and advisory services. There are uncertainties regarding the amount and timing of the outflows. However, it is expected that this results in payments within a year.

Other provisions mainly include obligations for other taxes.

27. OTHER NON-FINANCIAL LIABILITIES

Other non-financial liabilities are as follows:

T 127 OTHER NON-FINANCIAL LIABILITIES

IN EUR THOUSANDS	Dec 31, 2018	Dec 31, 2017
Non-current		
Government grants	391	446
Other liabilities	40	43
	431	489
Current		
Government grants	1,068	50
Non-income tax liabilities	2,398	2,004
Social liabilities	4,521	5,582
Personnel-related liabilities (e.g. vacation, bonuses, premiums)	18,671	23,274
Other liabilities	326	950
	26,984	31,860
Total other non-financial liabilities	27.415	32.349

NORMA Group received government grants of which EUR 1,459 thousand were not recognized in profit or loss. They consist of grants in cash as well as land. The grants are bound to capital expenditures, employees and the supply of equity of the respective local entities. NORMA Group recognizes the government grants as income over the period in which related expenses occur. In 2018, EUR 603 thousand were recognized as income (2017: EUR 409 thousand).

106 Consolidated Statement of Comprehensive Income
 107 Consolidated Statement of Financial Position
 108 Consolidated Statement of Cash Flows
 109 Consolidated Statement of Changes in Equity
110 Notes to the Consolidated Financial Statements
 197 Appendix to the Notes to the Consolidated Financial Statements
 200 Responsibility Statement
 201 Independent Auditor's Report

OTHER NOTES

28. INFORMATION ON THE CONSOLIDATED STATEMENT OF CASH FLOWS

In the statement of cash flows, a distinction is made between cash flows from operating activities, investing activities and financing activities.

Net cash provided by operating activities is derived indirectly from profit for the period. The profit for the period is adjusted to eliminate non-cash expenses such as depreciation and amortization as well as expenses and payments for which the cash effects are investing or financing cash flows and to eliminate other non-cash expenses and income. Net cash provided by operating activities of EUR 130,843 thousand (2017: EUR 145,996 thousand) represents changes in current assets, provisions and liabilities (excluding liabilities in connection with financing activities).

As in the prior year, the Group participates in a reverse factoring program, a factoring program and an ABS program. Liabilities in the reverse factoring program are reported under trade and other payables. As of December 31, 2018, reverse factoring liabilities in the amount of EUR 19,200 thousand are recognized (Dec 31, 2017: EUR 25,398 thousand). ► **NOTE 20(E) 'TRADE AND OTHER PAYABLES'** The cash flows from the reverse factoring, the factoring and the ABS program are shown under the cash flow from operating activities as this corresponds to the economic substance of the transactions.

The total amount of trade receivables sold within the factoring and ABS program can be found in ► **NOTE 20. (B) 'TRADE RECEIVABLES AVAILABLE FOR TRANSFER'**

Net cash provided by operating activities includes in 2018 cash outflows from the payments of the cash-settled share-based payments in the amount of EUR 3,513 thousand (2017: EUR 3,981 thousand), which result from the MSP tranche 2014 (2017: tranche 2013) for the Management Board of NORMA Group and from the Long-Term Incentive Plan (LTI) for NORMA Group employees.

The correction of expenses due to measurement of derivatives in the amount of EUR 436 thousand (2017: income in the amount of EUR 4,552 thousand) relates to fair value gains and losses recognized within the income statement assigned to the cash flows from financing activities.

Other non-cash income (-)/expenses (+) in net cash provided by operating activities mainly include foreign exchange rate gains and losses on external debt and intragroup monetary items in the amount of EUR -716 thousand (2017: EUR 5,911 thousand).

Furthermore, other non-cash income (-)/expenses (+) include non-cash interest expenses from the amortization of accrued costs, amounting to EUR 303 thousand (2017: EUR 354 thousand).

Cash flows resulting from interest paid are disclosed as cash flows from financing activities.

Cash flows from investing activities include net cash outflows from the acquisition and disposal of property, plant and equipment and intangible assets amounting to EUR 59,711 thousand (2017: EUR 47,016 thousand) including the change of liabilities from investments in property, plant and equipment and intangible assets amounting to EUR -2,412 thousand (2017: EUR 217 thousand). From the investments in non-current assets of EUR 63,255 thousand (2017: EUR 47,654 thousand), expenditures in the amount of EUR 42,793 thousand (2017: EUR 28,507 thousand) relate to growth and expenditures amounting to EUR 20,462 thousand (2016: EUR 19,147 thousand) to maintenance and continuous improvements.

In 2018, net payments for acquisitions of subsidiaries in the amount of EUR 69,797 thousand (2017: EUR 23,746 thousand) which result from the payments due to the acquisition of Kimplas and Statek as well as from payments in connection with the acquisition of Fengfan acquired in the second quarter of 2017 are also included in the cash flows from investing activities. Furthermore, net payments for acquisitions of subsidiaries consist of acquired cash and cash equivalents in the amount of EUR 866 thousand. ► **NOTE 32 'BUSINESS COMBINATIONS'**

The net payments for acquisitions of subsidiaries of the prior year result from the acquisition of Fengfan in the amount of EUR 12,185 thousand and from the acquisition of Lifial in the amount of EUR 11,909 thousand. Furthermore, a payment related to the acquisition of the Autoline business in the fourth quarter of 2016 in the amount of EUR 1,090 was included. The net payments for acquisitions of subsidiaries in 2018 and 2017 were as follows:

T 128 NET PAYMENTS FOR ACQUISITIONS OF SUBSIDIARIES

IN EUR THOUSANDS	2018	2017
Acquisition liability at the beginning of the period	2,981	0
Payment for acquisitions	69,341	28,173
Acquired cash and cash equivalents	-866	-1,438
Other changes	8	-8
Less acquisition liability at the end of the period	546	2,981
Less payments for shares in a subsidiary ¹	1,121	0
Net payments for acquisitions of subsidiaries	69,797	23,746

¹Shown within 'Net cash provided by/ used in financing activities'

Cash flows from financing activities mainly comprise outflows resulting from the payment of the dividend to shareholders of NORMA Group, amounting to EUR 33,456 thousand (2017: EUR 30,269 thousand), cash outflows resulting from interest paid (2018: EUR 13,676 thousand, 2017: EUR 13,672 thousand) as well as repayments of derivatives in the amount of EUR 409 thousand (2017: proceeds of EUR 4,941 thousand).

Furthermore, net proceeds from loans amounting to EUR 80,201 thousand (2017: net repayments of EUR 42,255 thousand), dividend payments to non-controlling interests in the amount of EUR 134 thousand (2017: EUR 159 thousand) and repayments from finance lease liabilities in the amount of EUR 123 thousand (2017: EUR 201 thousand) are disclosed as cash flows from financing activities. ► **NOTE 20. (E) 'FINANCIAL LIABILITIES AND NET DEBT'**

In addition, payments for the acquisition of shares in a subsidiary from the acquisition of non-controlling interests in the amount of EUR 1,121 thousand are included in the cash flow from financing activities

In fiscal year 2017, proceeds in connection with the acquisition of Fengfan, from outstanding capital contributions to a newly acquired subsidiary from former owners in the amount of EUR 3,924 thousand are included in the cash flows from financing activities.

The changes in balance sheet items that are presented in the Consolidated Statement of Cash Flows cannot be derived directly from the balance sheet, as the effects of currency translation are non-cash transactions and changes in the consolidated Group are shown directly in the net cash used in investing activities.

Cash is comprised of cash on hand and demand deposits of EUR 185,870 thousand on December 31, 2018 (Dec 31, 2017: EUR 155,198 thousand), as well as cash equivalents with a value of EUR 4,522 thousand (Dec 31, 2017: EUR 125 thousand).

Cash from China, India, Russia, Brazil and Malaysia (Dec 31, 2018: EUR 29,999 thousand, Dec 31, 2017: EUR 21,760 thousand) cannot currently be distributed due to restrictions on capital movements.

RECONCILIATION OF DEBT MOVEMENTS TO CASH FLOWS FROM FINANCING ACTIVITIES

The following table represents the reconciliation from the opening balance sheet values of the financial statements of debt arising from financing activities for the relevant closing balance sheet items and which led to changes in equity.

T 129 RECONCILIATION OF CHANGES IN ASSETS AND LIABILITIES TO CASH FLOWS FROM FINANCING ACTIVITIES

	Note	Financial liabilities				Derivatives held to hedge financial liabilities (assets (-)/liabilities (+))		Equity	Other effects	Total	
		Short- term loans payable	Long-term loans payable	Borrow- ings from the ABS/ factoring programs	Finance lease ob- ligations	Interest rate swaps – cash flow hedge	Foreign cur- rency deriv- atives – fair value hedge	Retained earnings	Non- con- trolling interests		
IN EUR THOUSANDS											
Balance as of December 31, 2017		33,136	455,111	0	156	-659	-32	298,077	2,423	0	788,212
Changes in cash flow from financing activities											
Loan proceeds	(20.(e))		102,000	15,467							117,467
Loan repayments	(20.(e))	-37,266									-37,266
Inflow (+)/outflow (-) from hedging derivatives	(20.(f))						-409				-409
Interest paid		-13,676									-13,676
Repayment of debts from finance leases	(20.(e))				-123						-123
Dividends paid	(23)							-33,456	-134		-33,590
Proceeds from original shareholders from outstanding capital contributions to a newly acquired subsidiary	(23)									-1,121	-1,121
Total change in cash flow from financing activities	(28)	-50,942	102,000	15,467	-123	0	-409	-33,456	-134	-1,121	31,282
Changes from the acquisition or loss of subsidiaries or other business operations		6,842						342	-342	n/a	6,842
Effects of changes in exchange rates		169	9,253		-7				-132	n/a	9,283
Changes in the fair value						-1,237	437			n/a	-800
Other changes											
Based on debt											
Interest expense		13,219	303		6			n/a	n/a	n/a	13,528
New finance leases								n/a	n/a	n/a	0
Transfer		110,908	-110,908					n/a	n/a	n/a	0
Other changes related to debt		124,127	-110,605	0	6	0	0	n/a	n/a	n/a	13,528
Other changes related to equity	(23)	n/a	n/a	n/a	n/a	n/a	n/a	91,059	-98	n/a	90,961
Balance as of December 31, 2018		113,332	455,759	15,467	32	-1,896	-4	356,022	1,717	-1,121	939,308

29. SEGMENT REPORTING

T 130 SEGMENT REPORTING

IN EUR THOUSANDS	EMEA		Americas		Asia-Pacific		Total segments		Central functions		Consolidation		Consolidated Group	
	2018	2017	2018	2017	2018	2017	2018	2017	2018	2017	2018	2017	2018	2017
Total revenue	543,126	527,935	451,171	423,054	151,293	124,227	1,145,590	1,075,216	26,554	24,050	-88,004	-82,182	1,084,140	1,017,084
thereof inter-segment revenue	48,322	42,060	9,657	11,782	3,471	4,290	61,450	58,132	26,554	24,050	-88,004	-82,182	0	0
Revenue from external customers	494,804	485,875	441,514	411,272	147,822	119,937	1,084,140	1,017,084	0	0	0	0	1,084,140	1,017,084
Contribution to consolidated Group sales	46 %	48 %	41 %	40 %	13 %	12 %	100 %	100 %						
Adjusted gross profit ¹	306,174	305,095	254,089	243,749	67,234	55,392	627,497	604,236	n/a	n/a	-920	-2,930	626,577	601,306
Adjusted EBITDA¹	95,534	105,462	87,175	84,540	22,977	19,108	205,686	209,110	-4,025	-9,341	-297	-21	201,364	199,748
Adjusted EBITDA margin ^{1,2}	17.6 %	20.0 %	19.3 %	20.0 %	15.2 %	15.4 %							18.6 %	19.6 %
Depreciation without PPA depreciation ³	-13,162	-11,550	-8,886	-8,915	-4,712	-3,440	-26,760	-23,905	-1,422	-1,325	0	0	-28,182	-25,230
Adjusted EBITA¹	82,372	93,912	78,289	75,625	18,265	15,668	178,926	185,205	-5,447	-10,666	-297	-21	173,182	174,518
Adjusted EBITA margin ^{1,2}	15.2 %	17.8 %	17.4 %	17.9 %	12.1 %	12.6 %							16.0 %	17.2 %
Assets ⁴	624,446	601,335	649,757	599,880	250,416	159,056	1,524,619	1,360,271	361,153	383,616	-414,086	-431,857	1,471,686	1,312,030
Liabilities ⁵	198,342	206,488	291,204	292,760	54,814	54,016	544,360	553,264	671,394	601,915	-346,509	-377,470	869,245	777,709
CAPEX	28,275	22,931	21,103	16,276	11,707	7,004	61,085	46,211	2,170	1,522	n/a	n/a	63,255	47,733
Number of employees ⁶	3,613	3,259	1,727	1,495	1,160	931	6,500	5,685	114	106	n/a	n/a	6,614	5,791

1_ For details regarding the adjustments, refer to ► NOTE 7.

2_ Based on segment sales.

3_ Depreciation from purchase price allocations.

4_ Including allocated goodwill, taxes are shown in the column 'consolidation.'

5_ Taxes are shown in the column 'consolidation.'

6_ Number of employees (average headcount).

NORMA Group segments the Group at a regional level. The reportable segments of NORMA Group are EMEA, the Americas and Asia-Pacific. NORMA Group's vision includes regional growth targets. Distribution Services are focused regionally and locally. EMEA, the Americas and Asia-Pacific have linked regional intercompany organizations with different functions. As a result, the Group's management reporting and controlling system has a regional focus. The product portfolio does not vary significantly between these segments.

Revenues of each segment are generated from the three product categories clamps (CLAMP), joining elements (CONNECT) and fluid systems/connectors (FLUID).

NORMA Group measures the performance of its segments through profit or loss indicators which are referred to as 'adjusted EBITDA' and 'adjusted EBITA.'

'Adjusted EBITDA' comprises revenue, changes in inventories of finished goods and work in progress, other own work capitalized, raw materials and consumables used, other operating income and expenses, and employee benefits expense, adjusted for material one-time effects. EBITDA is measured in a manner consistent with that used in the Consolidated Statement of Comprehensive Income.

'Adjusted EBITA' includes, in addition to EBITDA, the depreciation adjusted for depreciation from purchase price allocations.

In 2018, acquisition-related expenses in connection with the acquisition of Kimplas and Statek in the amount of EUR 2,157 thousand were adjusted within EBITDA and EBITA. In addition, adjustments were made for the rightsizing program to help optimize organizational structures, which started in the fourth quarter of 2018. ► **NOTE 7 'ADJUSTMENTS'**

Inter-segment revenue is recorded at values that approximate third-party selling prices.

Segment assets comprise all assets less (current and deferred) income tax assets. Taxes are shown in the reconciliation. Segment assets and liabilities are measured in a manner consistent with that used in the Consolidated Statement of Financial Position. Assets of the 'Central Functions' include mainly cash and intercompany receivables.

Segment liabilities comprise all liabilities less (current and deferred) income tax liabilities. Taxes are shown in the consolidation. Segment assets and liabilities are measured in a manner consistent with that used in the Consolidated Statement of Financial Position. Liabilities of the 'Central Functions' include mainly borrowings.

Capex equals additions to non-current assets (property, plant and equipment and other intangible assets).

Current and deferred tax assets and liabilities are shown in the consolidation. On December 31, 2018, EUR 14,256 thousand (Dec 31, 2017: EUR 14,805 thousand) in tax assets and EUR 79,679 thousand (Dec 31, 2017: EUR 68,503 thousand) in tax liabilities were shown in the consolidation.

External sales per country, measured according to the place of domicile of the company which manufactures the products, are as follows:

T 131 EXTERNAL SALES PER COUNTRY

IN EUR THOUSANDS	2018	2017
Germany	203,820	200,563
USA, Mexico, Brazil	441,514	411,272
Other countries	438,806	405,249
	1,084,140	1,017,084

Non-current assets per country include non-current assets less deferred tax assets, derivative financial instruments, and shares in consolidated related parties and are as follows:

T 132 NON-CURRENT ASSETS PER COUNTRY

IN EUR THOUSANDS	Dec 31, 2018	Dec 31, 2017
Germany	132,109	117,021
USA, Mexico, Brazil	449,366	434,498
Sweden	48,501	49,116
Other countries	299,932	231,007
Consolidation	- 10,401	- 12,919
	919,507	818,723

30. CONTINGENCIES

The Group has contingent liabilities in respect of legal claims arising in the ordinary course of business (e.g. warranty obligations).

NORMA Group does not believe that any of these contingent liabilities will have a material adverse effect on its business or any material liabilities will arise from contingent liabilities.

31. COMMITMENTS

CAPITAL COMMITMENTS

Capital expenditure (nominal value) contracted for on the balance sheet date but not yet incurred is as follows:

T 133 COMMITMENTS

IN EUR THOUSANDS	Dec 31, 2018	Dec 31, 2017
Property, plant and equipment	8,774	7,538
Inventory	1,030	1,484
Service contracts	0	109
	9,804	9,131

There are no material commitments concerning intangible assets.

OPERATING LEASE COMMITMENTS

The Group leases various vehicles, property and technical equipment under non-cancellable operating lease agreements. The lease terms are between 1 and 15 years. The Group also leases various technical equipment under cancellable operating lease agreements.

NORMA Group has significant operating lease arrangements with annual lease payments of more than EUR 200 thousand concerning the leasing of land and buildings. Except for usual renewable options, the lease contracts do not comprise other options. The lease arrangements are held by the following companies.

- ▶ NORMA UK Ltd. (Great Britain): lease term from 2006 to 2016, prolonged to 2021, soonest termination in 2021,
- ▶ NORMA Pacific Pty Ltd. (Australia): lease term from 2016 to 2021, soonest termination in 2021,
- ▶ NORMA Michigan Inc. (USA): lease term from 2013 to 2019, prolonged to 2024, soonest termination in 2024,
- ▶ Connectors Verbindungstechnik AG (Switzerland): lease term from 2012 to 2019, soonest termination in 2019,
- ▶ National Diversified Sales, Inc. (USA): lease term from 2013 to 2020, soonest termination in 2020; 2016 to 2019, soonest termination in 2019; 2016 to 2021, soonest termination in 2021, 2017 to 2019, soonest termination in 2019 and 2018 to 2023, soonest termination in 2023,
- ▶ R.G.RAY Corporation (USA): lease term from 2014 to 2019, soonest termination in 2019.

Lease expenditure (including non-cancellable and cancellable operating leases) amounting to EUR 11,838 thousand in 2018 (2017: EUR 10,967 thousand) is included in profit or loss in 'other operating expenses.'

The following table shows the future aggregate minimum lease payments (nominal value) under non-cancellable operating leases:

T 134 FUTURE MINIMUM LEASE PAYMENTS OF NON-CANCELLABLE OPERATING LEASES

IN EUR THOUSANDS	Dec 31, 2018	Dec 31, 2017
Up to 1 year	6,986	8,579
> 1 year up to 5 years	13,677	11,496
> 5 years	1,242	933
	21,905	21,008

32. BUSINESS COMBINATIONS

KIMPLAS PIPING SYSTEMS LTD. ('KIMPLAS')

On July 5, 2018, NORMA Group acquired all shares in Kimplas Piping Systems Ltd. ('Kimplas'), based in Nashik in Western India.

Kimplas has been developing and producing thermoplastic connection solutions since 1996, including compression fittings, sprinklers and drippers as well as valves and filters. The company has about 690 employees. Kimplas' certified products are used in drinking water treatment and in supplying drinking water and gas to households, as well as in water-saving micro-irrigation systems for agriculture. Its products are sold primarily in India and other Asian countries. In the past fiscal year (04/01/2017 to 03/31/2018), Kimplas generated preliminary sales of around EUR 21 million. The acquisition of Kimplas will see NORMA Group expand its water management portfolio and strengthen its position in Asia.

Goodwill of EUR 20,037 thousand derives from the acquisition, which mainly relates to not separable intangible assets, like expansion of its market position, the expertise of its employees and expected synergy effects.

Of the consideration of EUR 53,554 thousand, EUR 53,554 thousand were paid in cash.

None of the goodwill recognized is expected to be deductible for income tax purposes.

The following table summarizes the consideration paid for Kimplas and the assets acquired and liabilities assumed recognized as of the acquisition date:

T 135 PURCHASE PRICE ALLOCATION KIMPLAS

IN EUR THOUSANDS

106	Consolidated Statement of Comprehensive Income	Consideration on July 5, 2018	53,554
		Acquisition-related costs (included in other operating expenses in the Consolidated Statement of Comprehensive Income)	1,012
107	Consolidated Statement of Financial Position	Recognized amounts of identifiable assets acquired and liabilities assumed	
		Cash and cash equivalents	717
		Property, plant and equipment	12,437
108	Consolidated Statement of Cash Flows	Trademarks	1,865
		Customer lists	20,228
		Technology	9,332
109	Consolidated Statement of Changes in Equity	Software	209
		Inventory	3,925
		Trade and other receivables	10,705
		Other financial assets	190
		Other non-financial assets	480
110	Notes to the Consolidated Financial Statements	Trade and other payables	-7,076
		Personnel-related liabilities	-80
		Other non-financial liabilities	-1,844
197	Appendix to the Notes to the Consolidated Financial Statements	Other borrowings	-6,484
		Other financial liabilities	-1,097
200	Responsibility Statement	Tax assets	928
		Tax liabilities	-113
		Deferred tax liabilities	-10,805
201	Independent Auditor's Report	Total identifiable net assets	33,517
		Goodwill	20,037
			53,554

In the purchase price allocation, mainly intangible assets were identified. Customer lists were assessed using the 'Multi Period Excess Earnings Method' amounting to EUR 20,228 thousand. Trademarks were assessed using the 'Relief from Royalty Method' amounting to EUR 1,865 thousand. Patents & technology of EUR 9,332 thousand were assessed using the 'Relief from Royalty Method.'

The land use right in the amount of EUR 3,862 thousand, included in property, plant and equipment, was evaluated using the 'Market Approach.'

The fair value of trade and other receivables amounts to EUR 10,705 thousand and includes trade receivables with a fair value of EUR 10,681 thousand. The book value of the acquired trade receivables amounts to EUR 10,743 thousand, of which EUR 62 thousand were impaired.

Other borrowings and finance lease liabilities were fully repaid as of Dec 31, 2018. Including these payments, the payment for the acquisition was EUR 60,038 thousand.

The revenue included in the Consolidated Statement of Comprehensive Income contributed by Kimplas was EUR 10,169 thousand since July 5, 2018 (acquisition date). During this period, Kimplas contributed EUR 1,409 thousand to the consolidated result (the reported result does not include the step-up effects from the purchase price allocation of Kimplas).

Had Kimplas been consolidated from January 1, 2018, the Consolidated Statement of Comprehensive Income would show revenue of EUR 18,731 thousand for Kimplas and Kimplas would have contributed a gain of EUR 2,252 thousand (the reported result does not include the step-up effects from the purchase price allocation of Kimplas).

STATEK STANZEREITECHNIK GMBH ('STATEK')

NORMA Group acquired all shares in Statek Stanzereitechnik GmbH ('Statek'), based in Maintal, Germany, with economic effect on August 1, 2018.

Statek has been supplying NORMA Group with housings and tension springs for worm-drive hose clamps for many years. In 2017, Statek achieved sales of around EUR 17.2 million of which 70 percent were generated with its largest customer NORMA Group. Statek supplies other customers in Germany and internationally in the electrical engineering, automotive and reactor technology sectors. Founded in 1980, the company is based in Maintal and employs around 60 people. Statek's expertise in stamping and forming technology will enable NORMA Group to increase the supply reliability of its metal product components and further expand its market share in the field.

106	Consolidated Statement of Comprehensive Income
107	Consolidated Statement of Financial Position
108	Consolidated Statement of Cash Flows
109	Consolidated Statement of Changes in Equity
110	Notes to the Consolidated Financial Statements
197	Appendix to the Notes to the Consolidated Financial Statements
200	Responsibility Statement
201	Independent Auditor's Report

Goodwill of EUR 3,785 thousand derives from the acquisition, which mainly relates to production synergies resulting from the acquisition.

Of the consideration of EUR 13,609 thousand, EUR 13,609 thousand were paid in cash.

None of the goodwill recognized is expected to be deductible for income tax purposes.

The following table summarizes the consideration paid for Statek and the assets acquired and liabilities assumed recognized as of the acquisition date:

T 136 PURCHASE PRICE ALLOCATION STATEK

IN EUR THOUSANDS

Consideration on August 1, 2018	13,609
Acquisition-related costs (included in other operating expenses in the Consolidated Statement of Comprehensive Income)	241
Recognized amounts of identifiable assets acquired and liabilities assumed	
Cash and cash equivalents	149
Property, plant and equipment	3,135
Patented technology	9,450
Software	35
Inventory	1,422
Trade and other receivables	836
Other non-financial assets	108
Trade and other payables	-736
Personnel-related liabilities	-496
Other non-financial liabilities	-92
Other borrowings	-358
Other provisions	-85
Tax liabilities	-318
Deferred tax liabilities	-3,226
Total identifiable net assets	9,824
Goodwill	3,785
	13,609

In the purchase price allocation, mainly patents and technology were identified. As the leading intangible asset, patents and technology in the amount of

EUR 9,450 thousand were assessed using the 'Multi Period Excess Earnings Method (MEEM).'

The revenue included in the Consolidated Statement of Comprehensive Income contributed by Statek was EUR 2,107 thousand since August 1, 2018 (acquisition date). During this period, Statek contributed EUR 958 thousand to the consolidated result (the reported result does not include the step-up effects from the purchase price allocation of Statek).

Had Statek been consolidated from January 1, 2018, the Consolidated Statement of Comprehensive Income would show revenue of EUR 5,504 thousand for Statek. Due to Statek's strong interrelationship with other NORMA Group companies, around 70 percent of revenues were generated with NORMA Group companies, no profit can be shown for the period from January 1, 2018, to July 31, 2018.

33. RELATED PARTY TRANSACTIONS

SALES AND PURCHASES OF GOODS AND SERVICES

In 2018 and 2017, no management services were bought from related parties.

There were no material sales or purchases of goods and services from non-consolidated companies, from the shareholders of NORMA Group, from key management or from other related parties in 2018 and 2017.

COMPENSATION OF MEMBERS OF THE MANAGEMENT BOARD

Compensation of the members of the Management Board according to IFRS is as follows:

T 137 COMPENSATION OF MEMBERS OF THE MANAGEMENT BOARD (IFRS)

IN EUR THOUSANDS	2018	2017
Short-term benefits	4,215	2,282
Other long-term benefits	10	583
Termination benefits	763	248
Share-based payment	-526	3,078
Total compensation according to IFRS	4,462	6,191

Provisions for the compensation of the members of the Management Board are as follows:

106 Consolidated Statement of Comprehensive Income

107 Consolidated Statement of Financial Position

108 Consolidated Statement of Cash Flows

109 Consolidated Statement of Changes in Equity

110 Notes to the Consolidated Financial Statements

197 Appendix to the Notes to the Consolidated Financial Statements

200 Responsibility Statement

201 Independent Auditor's Report

T 138 PROVISIONS FOR COMPENSATION OF THE MANAGEMENT BOARD MEMBERS

IN EUR THOUSANDS	Note	Dec 31, 2018	Dec 31, 2017
LTI – Management Board	(26)	706	1,428
STI – Management Board	(26)	1,706	856
Matching Stock Program (MSP)	(24)	948	3,858
NORMA VA Bonus	(26)	1,256	314
Total		4,616	6,456

Details regarding the individual provisions can be found in the respective notes.

Besides the provisions shown above, a defined benefit obligation exists for the Management Board. The present value of the obligation amounts to EUR 1,776 thousand as of December 31, 2018 (Dec 31, 2017: EUR 559 thousand). ▶ **NOTE 25 'RETIREMENT BENEFIT OBLIGATIONS'**

Details regarding the compensation of the Management Board can be found in the ▶ **REMUNERATION REPORT, P. 91.**

34. ADDITIONAL DISCLOSURES PURSUANT TO SECTION 315E (1) OF THE GERMAN COMMERCIAL CODE (HGB)

COMPENSATION OF BOARD MEMBERS

The remuneration of the Management Board and Supervisory Board was as follows:

T 139 COMPENSATION OF BOARD MEMBERS

IN EUR THOUSANDS	2018	2017
Total Management Board	4,287	5,943
Total Supervisory Board	446	460
	4,733	6,403

The remuneration of the members of the Management Board was as follows:

T 140 COMPENSATION OF MEMBERS OF THE MANAGEMENT BOARD (SECTION 315A HGB)

IN EUR THOUSANDS	Bernd Kleinhens		Dr. Michael Schneider		Dr. Friedrich Klein (as of Oct 1, 2018)		Werner Deggim (until Dec 31, 2017)		John Stephenson (until Jan 31, 2018)		Total	
	2018	2017	2018	2017	2018	2017	2018	2017	2018	2017	2018	2017
Fixed compensation	524	320	387	341	83	0	234	471	24	294	1,252	1,426
Variable compensation	1,011	90	590	0	106	0	0	135	0	84	1,707	309
Long-term incentives	591	1,256	591	861	74	0	64	1,462	8	629	1,328	4,208
Total compensation	2,126	1,666	1,568	1,202	263	0	298	2,068	32	1,007	4,287	5,943

Besides these expenses, expenses for a defined benefit obligation were recognized in 2018 as follows ► **NOTES 25 'RETIREMENT BENEFIT OBLIGATIONS':**

T 141 SECTION 314 PARA 1 NO 6A HGB: RETIREMENT BENEFIT OBLIGATIONS

IN EUR THOUSANDS	Bernd Kleinhens		Dr. Michael Schneider		Dr. Friedrich Klein (as of Oct 1, 2018)		Total	
	2018	2017	2018	2017	2018	2017	2018	2017
Present value of the obligation	371	0	1,005	479	53	0	1,429	479
Amount spent / deferred	371	0	526	248	53	0	950	248

106 Consolidated Statement of Comprehensive Income

107 Consolidated Statement of Financial Position

108 Consolidated Statement of Cash Flows

109 Consolidated Statement of Changes in Equity

110 Notes to the Consolidated Financial Statements

197 Appendix to the Notes to the Consolidated Financial Statements

200 Responsibility Statement

201 Independent Auditor's Report

FEES FOR THE AUDITOR

Fees for the auditor, PricewaterhouseCoopers GmbH Wirtschaftsprüfungsgesellschaft, Frankfurt/Main were expensed as follows:

T 142 FEES FOR THE AUDITOR

IN EUR THOUSANDS	2018	2017
Auditing services	662	613
Other confirmation services	38	58
Other services	116	55
	816	726

In addition to auditing services, the auditor provided confirmation services for financial covenants and for the EMIR audit. Other services include consulting services in connection with IFRS transition projects, the non-financial statement and IT systems.

HEADCOUNT

The average headcount breaks down as follows:

T 143 AVERAGE HEADCOUNT

NUMBER	2018	2017
Direct labor	3,226	2,705
Indirect labor	1,239	1,132
Salaried	2,149	1,954
	6,614	5,791

The category 'direct labor' consists of employees who are directly engaged in the production process. The numbers fluctuate according to the level of output. The category 'indirect labor' consists of personnel that does not directly produce products, but rather supports production. Salaried employees are employees in administrative/sales/central functions.

CONSOLIDATION

Name, place of domicile and share in capital pursuant to section 313 (2) No. 1 HGB of the consolidated group of companies is presented in ► **NOTE 4 'SCOPE OF CONSOLIDATION.'**

PROPOSAL FOR THE DISTRIBUTION OF EARNINGS

The Management Board proposes that a dividend of EUR 1.10 be paid as a dividend per bearer of shares, leading to a total dividend payment of EUR 35,048,640.

CORPORATE GOVERNANCE (SECTION 161 AKTG)

The Management Board and Supervisory Board have issued a Corporate Governance Declaration pursuant to section 161 of the German Stock Corporation Act (Aktengesetz) and made it available to shareholders on the website of NORMA Group.  INVESTORS.NORMAGROUP.COM

35. EXEMPTIONS UNDER SECTION 264, PARAGRAPH 3 OF THE GERMAN COMMERCIAL CODE (HGB)

In 2018, the following German subsidiaries made use of disclosure exemptions pursuant to section 264, paragraph 3 of the German Commercial Code (HGB):

- NORMA Group Holding GmbH, Maintal
- NORMA Distribution Center GmbH, Marsberg
- NORMA Germany GmbH, Maintal
- NORMA Verwaltungs GmbH, Maintal

36. EVENTS AFTER THE BALANCE SHEET DATE

As of March 8, 2019, no events were known that would have led to a material change in the disclosure or valuation of the assets and liabilities as of December 31, 2018.

APPENDIX TO THE NOTES TO THE CONSOLIDATED FINANCIAL STATEMENTS

VOTING RIGHTS NOTIFICATIONS

According to section 160 (1) No. 8 AktG, information regarding voting rights that have been notified to the Company pursuant to section 33 (1) or (2) of the German Securities Trading Act (Wertpapierhandelsgesetz – WpHG) must be disclosed.

The following table gives an overview of all voting rights notifications that have been sent to the Company as of March 8, 2019. It contains the information of the

last notification of each shareholder. The percentage and shares may have changed in the meantime.

All notifications of shareholder voting rights in the year under review and beyond are available on the website of NORMA Group.

 INVESTORS.NORMAGROUP.COM.

T 144 VOTING RIGHTS NOTIFICATIONS

Notifying party	Achievement of voting rights	Share in %	Shares	Pursuant to WpHG
Threadneedle (Lux), Bertrange, Luxembourg	February 28, 2019	5.004	1,594,389	§ 33, 34 WpHG
Ameriprise Financial Inc, Wilmington, Delaware, USA ¹	February 28, 2019	8.35	2,661,543	§ 33, 34 WpHG
Impax Asset Management Group plc, London, United Kingdom	February 12, 2019	5.08	1,617,656	§ 33, 34 WpHG
Threadneedle Investment Funds ICVC, London, United Kingdom	November 24, 2018	0.78	249,840	§ 33, 34 WpHG
Allianz Global Investors Fund SICAV, Senningerberg, Luxembourg	November 23, 2018	2.99	952,228	§ 33, 34 WpHG
SMALLCAP World Fund Inc, Baltimore, Maryland, USA	November 21, 2018	2.88	917,435	§ 33, 34 WpHG
Allianz SE, Munich, Germany	October 25, 2018	3.04	968,681	§ 33, 34 WpHG
BNP Paribas Asset Management France SAS, Paris, France	October 5, 2018	3.05	973,019	§ 33, 34 WpHG
WBC Holdings LP, Chicago, USA	August 16, 2018	2.99	954,745	§ 33, 34 WpHG
Allianz Global Investors GmbH, Frankfurt/Main, Germany	July 28, 2017	10.001	3,186,608	§ 33, 34 WpHG
AXA S.A., Paris, France ²	June 9, 2017	4.98	1,585,754	§ 33, 34 WpHG
The Capital Group Companies, Inc., Los Angeles, California, USA	March 7, 2014	3.05	973,100	§ 34 section 1 sentence 1 no. 6 in connection with sentence 2 and 3 WpHG

¹ The voting rights attributed to the notifying party are held by the following shareholder whose share in the voting rights in NORMA Group SE amounts to 3% or more: Threadneedle (Lux) (5.004%)

² Chain of controlled undertakings: AXA Investment Managers S.A. (4.52%)

106 Consolidated Statement of Comprehensive Income

107 Consolidated Statement of Financial Position

108 Consolidated Statement of Cash Flows

109 Consolidated Statement of Changes in Equity

110 Notes to the Consolidated Financial Statements

197 Appendix to the Notes to the Consolidated Financial Statements

200 Responsibility Statement

201 Independent Auditor's Report

INTRODUCTION

OUR VISION

TO OUR SHAREHOLDERS

CONSOLIDATED
MANAGEMENT REPORT

**CONSOLIDATED
FINANCIAL STATEMENTS**

FURTHER INFORMATION

106	Consolidated Statement of Comprehensive Income
107	Consolidated Statement of Financial Position
108	Consolidated Statement of Cash Flows
109	Consolidated Statement of Changes in Equity
110	Notes to the Consolidated Financial Statements
197	Appendix to the Notes to the Consolidated Financial Statements
200	Responsibility Statement
201	Independent Auditor's Report

CORPORATE BODIES OF NORMA GROUP SE

MEMBERS OF THE MANAGEMENT BOARD

Bernd Kleinhens

Master's degree in Mechanical Engineering,
Chief Executive Officer (CEO)

Dr. Michael Schneider

Master's degree in Economics,
Chief Financial Officer (CFO)

- ▶ Member of the Supervisory Board of Leitwerk AG, Appenweier, Germany
- ▶ Member of the Supervisory Board of accuris AG, Munich, Germany

Dr. Friedrich Klein

Master's degree in Mechanical Engineering
Chief Operating Officer (COO), since October 1, 2018

John Stephenson

Master's degree Science
Chief Operating Officer (COO)
until January 31, 2018

MEMBER OF THE SUPERVISORY BOARD

Lars M. Berg (Chairman of the Supervisory Board, since May 2018)

- ▶ Consultant
- ▶ Chairman of the Supervisory Board of Greater Than AB, Stockholm, Sweden
- ▶ Chairman of the Supervisory Board of Net Insight AB, Stockholm, Sweden (until May 8, 2018)

Erika Schulte (Vice Chairwoman, since May 17, 2018)

- ▶ Managing Director of Hanau Wirtschaftsförderung GmbH, Hanau, Germany
- ▶ No seats on other boards

Rita Forst (since May 17, 2018)

- ▶ Consultant
- ▶ Member of the Advisory Board of Joh. Winklhofer Beteiligungs GmbH & Co. KG (iwis), Munich, Germany
- ▶ Member of the Supervisory Board of ElringKlinger AG, Dettingen, Germany
- ▶ Member of the Advisory Board of Metalsa, S.A. de C.V., Monterrey, Mexico
- ▶ Member of the Advisory Board of Westport Fuel Systems Inc., Vancouver, Canada

106 Consolidated
Statement of
Comprehensive
Income

107 Consolidated
Statement of
Financial Position

108 Consolidated
Statement of
Cash Flows

109 Consolidated
Statement of
Changes in Equity

110 Notes to the
Consolidated Financial
Statements

**197 Appendix to the Notes
to the Consolidated
Financial Statements**

200 Responsibility
Statement

201 Independent
Auditor's Report

Günter Hauptmann

- ▶ Consultant
- ▶ Chairman of the Advisory Board of Atesteo GmbH (formerly GIF GmbH), Alsdorf, Germany (until February 14, 2018)
- ▶ Member of the Advisory Board of Moon TopCo GmbH (Schlemmer Group), Poing, Germany

Dr. Knut Michelberger

- ▶ Consultant
- ▶ Member of the Advisory Board of Rena Technologies GmbH, Gütenbach, Germany
- ▶ Member of the Supervisory Board of Weener Plastics Group, Ede, The Netherlands
- ▶ Vice Chairman of the Advisory Board of Racing TopCo GmbH, Troisdorf, Germany (since May 1, 2018)
- ▶ Member of the Advisory Board of Kaffee Partner Holding GmbH, Osnabrück, Germany
- ▶ Member of the Advisory Board of Moon TopCo GmbH, Poing (Schlemmer Group), Germany (since July 1, 2018)
- ▶ Member of the Advisory Board of Tegimus Holding GmbH, Mannheim, Germany (since July 1, 2018)

Maintal, March 8, 2019

NORMA Group SE

The Management Board

Mark Wilhelms (since August 29, 2018)

- ▶ Chief Financial Officer at Stabilus S.A., Luxembourg
- ▶ No seats on other boards

Dr. Christoph Schug (until May 17, 2018)

- ▶ Entrepreneur
- ▶ Member of the Advisory Board of Bomedus GmbH, Bonn, Germany
- ▶ Member of the Advisory Board of MoebelFirst GmbH, Cologne, Germany

Dr. Stefan Wolf (until May 17, 2018)

- ▶ Chief Executive Officer (CEO) of ElringKlinger AG, Dettingen, Germany
- ▶ Member of the Supervisory Board of Allgaier Werke GmbH, Uhingen, Germany
- ▶ Chairman of the Baden-Württemberg Employers' Association of the Metal and Electrical Industry 'Südwestmetall,' Mannheim, Germany
- ▶ Member of the Management Board of the German Association of the Automotive Industry (VDA), Frankfurt/Main, Germany
- ▶ Vice President of the Chamber of Industry and Commerce (IHK) Reutlingen/Tübingen/Zollernalb, Germany

Bernd Kleinhens
Chief Executive Officer (CEO)

Dr. Michael Schneider
Chief Financial Officer (CFO)

Dr. Friedrich Klein
Chief Operating Officer (COO)

RESPONSIBILITY STATEMENT

To the best of our knowledge, and in accordance with the applicable reporting principles, the Consolidated Financial Statements give a true and fair view of the assets, liabilities, financial position and profit or loss of the Group, and the Group Management Report includes a fair review of the development and performance of the business and the position of the Group, together with a description of the principal opportunities and risks associated with the expected development of the Group.

Maintal, March 8, 2019

NORMA Group SE

The Management Board

106 Consolidated Statement of Comprehensive Income

107 Consolidated Statement of Financial Position

108 Consolidated Statement of Cash Flows

109 Consolidated Statement of Changes in Equity

110 Notes to the Consolidated Financial Statements

197 Appendix to the Notes to the Consolidated Financial Statements

200 Responsibility Statement

201 Independent Auditor's Report

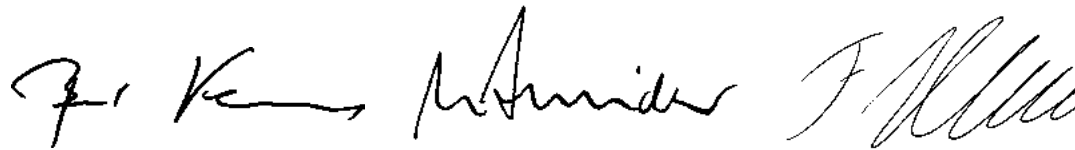

Bernd Kleinhens
Chief Executive Officer (CEO)

Dr. Michael Schneider
Chief Financial Officer (CFO)

Dr. Friedrich Klein
Chief Operating Officer (COO)

106	Consolidated Statement of Comprehensive Income
107	Consolidated Statement of Financial Position
108	Consolidated Statement of Cash Flows
109	Consolidated Statement of Changes in Equity
110	Notes to the Consolidated Financial Statements
197	Appendix to the Notes to the Consolidated Financial Statements
200	Responsibility Statement
201	Independent Auditor's Report

INDEPENDENT AUDITOR'S REPORT

To NORMA Group SE, Maintal

REPORT ON THE AUDIT OF THE CONSOLIDATED FINANCIAL STATEMENTS AND OF THE GROUP MANAGEMENT REPORT

AUDIT OPINIONS

We have audited the consolidated financial statements of NORMA Group SE, Maintal, and its subsidiaries (the Group), which comprise the consolidated statement of financial position as at December 31, 2018 and the consolidated statement of comprehensive income, consolidated statement of profit or loss, consolidated statement of changes in equity and consolidated statement of cash flows for the financial year from January 1 to December 31, 2018, and notes to the consolidated financial statements, including a summary of significant accounting policies. In addition, we have audited the group management report of NORMA Group SE for the financial year from January 1 to December 31, 2018. We have not audited the content of those parts of the group management report listed in the 'Other Information' section of our auditor's report.

In our opinion, on the basis of the knowledge obtained in the audit,

- ▶ the accompanying consolidated financial statements comply, in all material respects, with the IFRSs as adopted by the EU, and the additional requirements of German commercial law pursuant to § [Article] 315e Abs. [paragraph] 1 HGB [Handelsgesetzbuch: German Commercial Code] and, in compliance with these requirements, give a true and fair view of the assets, liabilities, and financial position of the Group as at December 31, 2018, and of its financial performance for the financial year from January 1 to December 31, 2018 and
- ▶ the accompanying group management report as a whole provides an appropriate view of the Group's position. In all material respects, this group management report is consistent with the consolidated financial statements, complies with German legal requirements and appropriately presents the opportunities and risks of future development. Our audit opinion on the group management report does not cover those parts of the group management report listed in the 'Other Information' section of our auditor's report.

Pursuant to § 322 Abs. 3 Satz [sentence] 1 HGB, we declare that our audit has not led to any reservations relating to the legal compliance of the consolidated financial statements and of the group management report.

BASIS FOR THE AUDIT OPINIONS

We conducted our audit of the consolidated financial statements and of the group management report in accordance with § 317 HGB and the EU Audit Regulation (No. 537/2014, referred to subsequently as "EU Audit Regulation") and in compliance with German Generally Accepted Standards for Financial Statement Audits promulgated by the Institut der Wirtschaftsprüfer [Institute of Public Auditors in Germany] (IDW).

Our responsibilities under those requirements and principles are further described in the "Auditor's Responsibilities for the Audit of the Consolidated Financial Statements and of the Group Management Report" section of our auditor's report. We are independent of the group entities in accordance with the requirements of European law and German commercial and professional law, and we have fulfilled our other German professional responsibilities in accordance with these requirements. In addition, in accordance with Article 10 (2) point (f) of the EU Audit Regulation, we declare that we have not provided non-audit services prohibited under Article 5 (1) of the EU Audit Regulation. We believe that the audit evidence we have obtained is sufficient and appropriate to provide a basis for our audit opinions on the consolidated financial statements and on the group management report.

106 Consolidated Statement of Comprehensive Income
 107 Consolidated Statement of Financial Position
 108 Consolidated Statement of Cash Flows
 109 Consolidated Statement of Changes in Equity
 110 Notes to the Consolidated Financial Statements
 197 Appendix to the Notes to the Consolidated Financial Statements
 200 Responsibility Statement
201 Independent Auditor's Report

KEY AUDIT MATTERS IN THE AUDIT OF THE CONSOLIDATED FINANCIAL STATEMENTS

Key audit matters are those matters that, in our professional judgment, were of most significance in our audit of the consolidated financial statements for the financial year from January 1 to December 31, 2018. These matters were addressed in the context of our audit of the consolidated financial statements as a whole, and in forming our audit opinion thereon; we do not provide a separate audit opinion on these matters.

In our view, the matters of most significance in our audit were as follows:

1. Recoverability of goodwill
2. Company acquisitions
3. Accounting treatment of a new factoring agreement

Our presentation of these key audit matters has been structured in each case as follows:

- a) Matter and issue
- b) Audit approach and findings
- c) Reference to further information

Hereinafter we present the key audit matters:

1. RECOVERABILITY OF GOODWILL

a) In the consolidated financial statements of NORMA Group SE a total amount of EUR 389.5 million, representing around 26% of total assets, is reported under the balance sheet item "Goodwill." The Company allocates goodwill to the groups of cash-generating units, which correspond to the Group's operating segments. Goodwill is tested for impairment ("impairment test") on an annual basis or if there are indications that goodwill may be impaired, to determine any possible need for write-downs. For the purposes of the impairment test the carrying amount of the relevant cash-generating unit is compared with its fair value less costs of disposal. This measurement is generally based on the present value of the future cash flows of the relevant cash-generating unit to which the respective goodwill is allocated. Present values are calculated using discounted cash flow models. For this purpose, the Group's five-year financial plan prepared by the executive directors and adopted by the supervisory board forms the starting point for future projections based on assumptions about long-term rates of growth. In doing so, expectations relating to future market developments and country-specific assumptions about the performance of macroeconomic indicators are also taken into account. The discount rate used is the weighted average cost of

capital for the relevant cash-generating unit. The outcome of this valuation is dependent to a large extent on the estimates made by the executive directors with respect to the future cash inflows from the respective group of cash-generating units, the discount rate used, the rate of growth and other assumptions, and is therefore subject to considerable uncertainty. Against this background and due to the complex nature of the valuation, this matter was of particular significance in the context of our audit.

- b) As part of our audit, we evaluated the methodology used for the purposes of performing the impairment test, among other things. We also assessed whether the future cash inflows underlying the measurements and the discount rates used on the whole provide an appropriate basis for the impairment tests of the individual cash-generating units. We assessed the appropriateness of the future cash inflows used in the calculation, inter alia, by comparing this data with the current budgets in the five-year financial plan prepared by the executive directors and approved by the supervisory board, and by reconciling it with general and sector-specific market expectations. In addition, we assessed whether the basis for including the costs of Group functions was appropriate. In the knowledge that even relatively small changes in the discount rate applied can have a material impact on the value of the entity calculated using this method, we focused our testing in particular on the parameters used to determine the discount rate applied, and assessed the calculation model. Furthermore, in addition to the analyses carried out by the Company we performed our own sensitivity analyses and, taking into account the information available, determined that the carrying amounts of the cash-generating units, including the allocated goodwill, were adequately covered by the discounted future net cash inflows. Overall, the measurement parameters and assumptions used by the executive directors are in line with our expectations and are also within ranges considered by us to be reasonable.
- c) The Company's disclosures on goodwill are contained in sections 3, 6 and 18 of the notes to the consolidated financial statements.

106	Consolidated Statement of Comprehensive Income
107	Consolidated Statement of Financial Position
108	Consolidated Statement of Cash Flows
109	Consolidated Statement of Changes in Equity
110	Notes to the Consolidated Financial Statements
197	Appendix to the Notes to the Consolidated Financial Statements
200	Responsibility Statement
201	Independent Auditor's Report

2. COMPANY ACQUISITIONS

- a) In the financial year 2018, NORMA Group SE acquired 100% of the shares in Kimplas Piping Systems Ltd., headquartered in Nashik, India. Furthermore, all of the shares in Statek Stanzereitechnik GmbH, headquartered in Maintal, Germany, were also purchased. The purchase price for the two acquisitions totaled EUR 67.2 million. In general, the assets and liabilities acquired are recognized at fair value as of the respective acquisition date, based on a number of assumptions made by the executive directors. After taking into account the share of the net assets acquired attributable to NORMA Group SE of EUR 43.4 million, the resulting purchased goodwill amounts in total to EUR 23.8 million. Due to the complexity of measuring the acquisitions and their material impact, in terms of amount, on the assets, liabilities, financial position, and financial performance of NORMA Group SE, they were of particular significance in the context of our audit.
- b) As part of our audit, we assessed the accounting treatment of the acquisitions with the assistance of our internal valuations specialists. For this purpose, we initially inspected and evaluated the respective contractual agreements underlying the acquisitions. At the same time, we reconciled the purchase prices paid by NORMA Group SE as consideration for the shares received with the supporting documentation for the payments made provided to us, among other procedures. We assessed the opening balance sheets underlying the aforementioned acquisitions. We evaluated the fair values, e.g. for customer relationships, calculated by a valuer appointed by NORMA Group SE by reconciling the numerical data with the original financial accounting records and the parameters used. We also used checklists to establish whether the requirements set out in IFRS 3 for disclosures in the notes to the consolidated financial statements had been complied with in full. In total, based on these and other procedures performed and the information available, we were able to satisfy ourselves that the acquisition of the respective shares was appropriately presented.
- c) The Company's disclosures pertaining to the acquisitions are contained in section 32 "Business combinations" of the notes to the consolidated financial statements.

3. ACCOUNTING TREATMENT OF A NEW FACTORING AGREEMENT

- a) In the financial year 2018, a subsidiary of NORMA Group SE joined a factoring programme. According to the underlying agreement, receivables from certain customers may be sold to the factor up to a certain volume. As of December 31, 2018, receivables in the amount of EUR 15.4 million were sold from this contractual relationship, of which EUR 3.2 million were not paid out as purchase price retentions, which are held as security reserves, and

were recognized as other financial assets. The security reserve is exclusively a verity guarantee and has no influence on the transfer of the del credere risk. As essentially all opportunities and risks have been transferred, the Group does not record any continuing involvement. The sale of trade receivables under a factoring agreement may result in a subsumption of the corresponding receivables under the "hold" business model no longer being possible. The receivables contained in the new factoring agreement are not held by NORMA Group SE to collect the cash flows, but at the time the receivable is received, the sale within the framework of the programme has already been determined. For this reason, NORMA Group SE reports trade receivables which are the subject of the factoring agreement in the fair value through profit or loss measurement category. Due to the complex contractual structure and the high requirements of IFRS 9 with regard to accounting and classification rules, the first-time recognition of the new factoring agreement was, in our view, of particular importance for our audit.

- b) As part of our audit, we included our internal specialists from Corporate Treasury Solutions in the evaluation of the factoring agreement and to comprehend the determination and accounting treatment of the new factoring transactions. For the purpose of assessing the accounting treatment of the factoring agreement, we have, among other things, inspected, comprehended and evaluated the contractual agreements. Together we dealt with the details of the contract, the information provided by the Company and the criteria of IFRS 9 regarding the requirements for the disposal and classification of financial assets. Based on our audit procedures, we were able to satisfy ourselves that the estimates and assumptions made by the executive directors are substantiated and sufficiently documented to ensure an appropriate presentation in the consolidated financial statements.
- c) The Company's disclosures pertaining to the new factoring agreement are contained in section 20(B) "Trade receivables transferred or available for transfer" of the notes to the consolidated financial statements.

OTHER INFORMATION

The executive directors are responsible for the other information. The other information comprises the following non-audited parts of the group management report:

- ▶ the group statement on corporate governance pursuant to § 289f HGB and § 315d HGB included in section "Principles of the group" of the group management report

106 Consolidated Statement of Comprehensive Income
 107 Consolidated Statement of Financial Position
 108 Consolidated Statement of Cash Flows
 109 Consolidated Statement of Changes in Equity
 110 Notes to the Consolidated Financial Statements
 197 Appendix to the Notes to the Consolidated Financial Statements
 200 Responsibility Statement
201 Independent Auditor's Report

- ▶ the corporate governance report pursuant to No. 3.10 of the German Corporate Governance Code
- ▶ the separate non-financial report pursuant to § 289b Abs. 3 HGB and § 315b Abs. 3 HGB

The other information comprises further the remaining parts of the annual report – excluding cross-references to external information – with the exception of the audited consolidated financial statements, the audited group management report and our auditor's report.

Our audit opinions on the consolidated financial statements and on the group management report do not cover the other information, and consequently we do not express an audit opinion or any other form of assurance conclusion thereon.

In connection with our audit, our responsibility is to read the other information and, in so doing, to consider whether the other information

- ▶ is materially inconsistent with the consolidated financial statements, with the group management report or our knowledge obtained in the audit, or
- ▶ otherwise appears to be materially misstated.

RESPONSIBILITIES OF THE EXECUTIVE DIRECTORS AND THE SUPERVISORY BOARD FOR THE CONSOLIDATED FINANCIAL STATEMENTS AND THE GROUP MANAGEMENT REPORT

The executive directors are responsible for the preparation of the consolidated financial statements that comply, in all material respects, with IFRSs as adopted by the EU and the additional requirements of German commercial law pursuant to § 315e Abs. 1 HGB and that the consolidated financial statements, in compliance with these requirements, give a true and fair view of the assets, liabilities, financial position, and financial performance of the Group. In addition the executive directors are responsible for such internal control as they have determined necessary to enable the preparation of consolidated financial statements that are free from material misstatement, whether due to fraud or error.

In preparing the consolidated financial statements, the executive directors are responsible for assessing the Group's ability to continue as a going concern. They also have the responsibility for disclosing, as applicable, matters related to going concern. In addition, they are responsible for financial reporting based on the going concern basis of accounting unless there is an intention to liquidate the Group or to cease operations, or there is no realistic alternative but to do so.

Furthermore, the executive directors are responsible for the preparation of the group management report that, as a whole, provides an appropriate view of the Group's position and is, in all material respects, consistent with the consolidated financial statements, complies with German legal requirements, and appropriately presents the opportunities and risks of future development. In addition, the executive directors are responsible for such arrangements and measures (systems) as they have considered necessary to enable the preparation of a group management report that is in accordance with the applicable German legal requirements, and to be able to provide sufficient appropriate evidence for the assertions in the group management report.

The supervisory board is responsible for overseeing the Group's financial reporting process for the preparation of the consolidated financial statements and of the group management report.

AUDITOR'S RESPONSIBILITIES FOR THE AUDIT OF THE CONSOLIDATED FINANCIAL STATEMENTS AND OF THE GROUP MANAGEMENT REPORT

Our objectives are to obtain reasonable assurance about whether the consolidated financial statements as a whole are free from material misstatement, whether due to fraud or error, and whether the group management report as a whole provides an appropriate view of the Group's position and, in all material respects, is consistent with the consolidated financial statements and the knowledge obtained in the audit, complies with the German legal requirements and appropriately presents the opportunities and risks of future development, as well as to issue an auditor's report that includes our audit opinions on the consolidated financial statements and on the group management report.

Reasonable assurance is a high level of assurance, but is not a guarantee that an audit conducted in accordance with § 317 HGB and the EU Audit Regulation and in compliance with German Generally Accepted Standards for Financial Statement Audits promulgated by the Institut der Wirtschaftsprüfer (IDW) will always detect a material misstatement. Misstatements can arise from fraud or error and are considered material if, individually or in the aggregate, they could reasonably be expected to influence the economic decisions of users taken on the basis of these consolidated financial statements and this group management report.

106	Consolidated Statement of Comprehensive Income
107	Consolidated Statement of Financial Position
108	Consolidated Statement of Cash Flows
109	Consolidated Statement of Changes in Equity
110	Notes to the Consolidated Financial Statements
197	Appendix to the Notes to the Consolidated Financial Statements
200	Responsibility Statement
201	Independent Auditor's Report

We exercise professional judgment and maintain professional skepticism throughout the audit. We also:

- ▶ Identify and assess the risks of material misstatement of the consolidated financial statements and of the group management report, whether due to fraud or error, design and perform audit procedures responsive to those risks, and obtain audit evidence that is sufficient and appropriate to provide a basis for our audit opinions. The risk of not detecting a material misstatement resulting from fraud is higher than for one resulting from error, as fraud may involve collusion, forgery, intentional omissions, misrepresentations, or the override of internal control.
- ▶ Obtain an understanding of internal control relevant to the audit of the consolidated financial statements and of arrangements and measures (systems) relevant to the audit of the group management report in order to design audit procedures that are appropriate in the circumstances, but not for the purpose of expressing an audit opinion on the effectiveness of these systems.
- ▶ Evaluate the appropriateness of accounting policies used by the executive directors and the reasonableness of estimates made by the executive directors and related disclosures.
- ▶ Conclude on the appropriateness of the executive directors' use of the going concern basis of accounting and, based on the audit evidence obtained, whether a material uncertainty exists related to events or conditions that may cast significant doubt on the Group's ability to continue as a going concern. If we conclude that a material uncertainty exists, we are required to draw attention in the auditor's report to the related disclosures in the consolidated financial statements and in the group management report or, if such disclosures are inadequate, to modify our respective audit opinions. Our conclusions are based on the audit evidence obtained up to the date of our auditor's report. However, future events or conditions may cause the Group to cease to be able to continue as a going concern.
- ▶ Evaluate the overall presentation, structure and content of the consolidated financial statements, including the disclosures, and whether the consolidated financial statements present the underlying transactions and events in a manner that the consolidated financial statements give a true and fair view of the assets, liabilities, financial position and financial performance of the Group in compliance with IFRSs as adopted by the EU and the additional requirements of German commercial law pursuant to § 315e Abs. 1 HGB.
- ▶ Obtain sufficient appropriate audit evidence regarding the financial information of the entities or business activities within the Group to express audit opinions on the consolidated financial statements and on the group management report. We are responsible for the direction, supervision and performance of the group audit. We remain solely responsible for our audit opinions.

- ▶ Evaluate the consistency of the group management report with the consolidated financial statements, its conformity with German law, and the view of the Group's position it provides.
- ▶ Perform audit procedures on the prospective information presented by the executive directors in the group management report. On the basis of sufficient appropriate audit evidence we evaluate, in particular, the significant assumptions used by the executive directors as a basis for the prospective information, and evaluate the proper derivation of the prospective information from these assumptions. We do not express a separate audit opinion on the prospective information and on the assumptions used as a basis. There is a substantial unavoidable risk that future events will differ materially from the prospective information.

We communicate with those charged with governance regarding, among other matters, the planned scope and timing of the audit and significant audit findings, including any significant deficiencies in internal control that we identify during our audit.

We also provide those charged with governance with a statement that we have complied with the relevant independence requirements, and communicate with them all relationships and other matters that may reasonably be thought to bear on our independence, and where applicable, the related safeguards.

From the matters communicated with those charged with governance, we determine those matters that were of most significance in the audit of the consolidated financial statements of the current period and are therefore the key audit matters. We describe these matters in our auditor's report unless law or regulation precludes public disclosure about the matter.

106 Consolidated
Statement of
Comprehensive
Income

107 Consolidated
Statement of
Financial Position

108 Consolidated
Statement of
Cash Flows

109 Consolidated
Statement of
Changes in Equity

110 Notes to the
Consolidated Financial
Statements

197 Appendix to the Notes
to the Consolidated
Financial Statements

200 Responsibility
Statement

**201 Independent
Auditor's Report**

OTHER LEGAL AND REGULATORY REQUIREMENTS

FURTHER INFORMATION PURSUANT TO ARTICLE 10 OF THE EU AUDIT REGULATION

We were elected as group auditor by the annual general meeting on May 17, 2018. We were engaged by the supervisory board on October 8, 2018. We have been the Group auditor of NORMA Group SE, Maintal, without interruption since fiscal year 2010.

We declare that the audit opinions expressed in this auditor's report are consistent with the additional report to the audit committee pursuant to Article 11 of the EU Audit Regulation (long-form audit report).

GERMAN PUBLIC AUDITOR RESPONSIBLE FOR THE ENGAGEMENT

The German Public Auditor responsible for the engagement is Thomas Tilgner.

Frankfurt/Main, March 8, 2019

PricewaterhouseCoopers GmbH
Wirtschaftsprüfungsgesellschaft

sgd. Thomas Tilgner	sgd. ppa. Benjamin Hessel
Wirtschaftsprüfer	Wirtschaftsprüfer
(German Public Auditor)	(German Public Auditor)

207 Glossary

- 211 List of Graphics
- 212 List of Tables
- 215 Overview
by Quarter 2018
- 216 Multi-Year Overview
- 218 Financial
Calendar 2019,
Contact and Imprint

FURTHER INFORMATION

GLOSSARY

5S METHODOLOGY

5S is a method for organizing a work space for efficiency and effectiveness in order to reduce industrial accidents.

AFTERMARKET SEGMENT

The market concerned with the maintenance/repair of investment goods or long-life final goods (e.g. vehicles) or the sale of replacement parts or complementary parts for the goods. This involves the sale of services and/or parts that are directly related to the previous sale of the goods.

APAC

Abbreviation for the Asia-Pacific region.

ASSET BACKED SECURITIES (ABS) PROGRAM

A specific way of converting payment claims into negotiable securities with a financing company.

BEST LANDED COST APPROACH

Assessment of the total costs of a product including the price of the product as well as the charges for shipping, taxes and/or duties.

BUBBLE ASSIGNMENT

Short-term exchange program for employees to promote internal knowledge transfer, intercultural awareness, the development of networks and the individual development of participants.

BREXIT

In a referendum on June 23, 2016, the citizens of the United Kingdom voted against the country remaining in the European Union (EU). The collective consequence of the EU exit has taken on the popular, unofficial term of Brexit.

CASH-POOLING

Consolidating liquidity within the Group through central financial management with the purpose of compensating for excess liquidity or liquidity shortfalls.

CODE OF CONDUCT

A set of policies which can and should be applied in a wide range of contexts and environments depending on the situation. In contrast to a rule, the target audience is not obliged to always comply with the Code of Conduct. A Code of Conduct is more of a personal commitment to follow or abstain from certain patterns of behavior, ensuring that nobody gains an unfair advantage by circumventing these patterns.

COMMODITY

A term used in procurement for any kind of material good used by traders.

COMPLIANCE

Conforming to rules: a company and its employees adhering to Codes of Conduct, laws and guidelines.

CORPORATE GOVERNANCE

A set of all international and national rules, regulations, values and principles which apply to companies and determine how these companies are to be managed and monitored.

CORPORATE RESPONSIBILITY

A form of corporate self-regulation integrated into a business model by taking societal and environmental aspects into account.

COVERAGE

The regular assessment of the economic and financial situation of a listed company by banks or financial research institutions.

CROSS-SELLING EFFECTS

The action or practice of selling an additional product or service to an existing customer.

DISTRIBUTION SERVICES (DS)

One of NORMA Group's two ways to market, providing a wide range of high-quality, standardized joining products for a broad range of applications and customers.

INTRODUCTION

OUR VISION

TO OUR SHAREHOLDERS

CONSOLIDATED
MANAGEMENT REPORT

CONSOLIDATED
FINANCIAL STATEMENTS

FURTHER INFORMATION

207 Glossary

211 List of Graphics

212 List of Tables

215 Overview
by Quarter 2018

216 Multi-Year Overview

218 Financial
Calendar 2019,
Contact and Imprint

E-PROCUREMENT

Electronic purchasing system.

EARNINGS BEFORE INTEREST, TAXES AND AMORTIZATION (EBITA)

EBITA describes earnings before interest, taxes and amortization of intangible assets. For long-term comparison and a better understanding of business development, NORMA Group adjusts the EBITA for certain one-time expenses. These are described in the Management Report as well as in the Notes to the Consolidated Financial Statements.

EARNINGS BEFORE INTEREST, TAXES, DEPRECIATION AND AMORTIZATION (EBITDA)

Earnings before interest, taxes, depreciation (of property, plant and equipment) and amortization (of intangible assets). It is a measure of a company's operating performance before investment expenses. For long-term comparison and a better understanding of its business development, NORMA Group adjusts the EBITDA for certain one-time expenses. These are described in the Management Report as well as in the Notes to the Consolidated Financial Statements.

EBITA MARGIN (ADJUSTED)

The adjusted EBITA margin is calculated from the ratio of adjusted EBITA to sales and is an indicator of the profitability of NORMA Group's business activities.

EBITDA MARGIN (ADJUSTED)

The adjusted EBITDA margin is calculated from the ratio of adjusted EBITDA to sales.

ECONOMIES OF SCALE

Indicates the ratio of the production volume to the production factors used. In the case of positive scale effects, the production output is also increased with the intensification of production factors.

ELASTOMERS

Stable but elastic plastics which are used at a temperature above their glass transition temperature. The plastics can deform under tensile or compressive load, but then return to their original shape.

EMEA

Abbreviation for the economic area of Europe (comprising Western and Eastern Europe), the Middle East and Africa.

ENGINEERED JOINING TECHNOLOGY (EJT)

One of NORMA Group's two ways to market. It provides customized, highly engineered joining technology products primarily, but not exclusively, for industrial OEM customers.

EQUITY RATIO

Equity in relation to total assets.

EUROPEAN MARKET INFRASTRUCTURE REGULATION (EMIR)

EU regulation that regulates the over-the-counter market with derivative products. The main stipulation of this regulation obligates market participants to clear their over-the-counter standard derivative transactions through a central counterparty and report these transactions to a trade repository.

FREE CASH FLOW

Indicates the amount of money that is available to pay dividends to shareholders and/or repay loans.

GEARING

Gearing is a measure of a company's debt level. Gearing is calculated from the ratio of net debt to equity.

GEMBA WALK

Daily walk through the production halls, inspecting individual processes in the opposite order of workflow and analyzing potential opportunities for improvements.

GLOBAL EXCELLENCE PROGRAM

A cost optimization program. It coordinates and manages all of NORMA Group's sites and business units.

IATF 16949

An international standard that combines the existing general demands on quality management systems of the (mostly North American and European) automotive industry.

INITIAL PUBLIC OFFERING (IPO)

First offering of shares of a company on the regulated capital market.

INNOVATION ROADMAPING

Systematic approach to adapt company-specific product innovations to future market and technological developments.



INTRODUCTION

OUR VISION

TO OUR SHAREHOLDERS

CONSOLIDATED
MANAGEMENT REPORT

CONSOLIDATED
FINANCIAL STATEMENTS

FURTHER INFORMATION

207 Glossary

211 List of Graphics

212 List of Tables

215 Overview
by Quarter 2018

216 Multi-Year Overview

218 Financial
Calendar 2019,
Contact and Imprint

INNOVATION SCOUTING

Structured observation of changes, potentials and relevant knowledge of technological developments and processes.

INTERNATIONAL SECURITIES IDENTIFICATION NUMBER (ISIN)

12-digit alphanumeric code used to identify a security traded on the stock market.

ISO 14001

An international environmental management standard that specifies the internationally accepted requirements for an environmental management system.

ISO 9001

International standard that defines the minimum requirements that quality management systems must meet.

KANBAN

Method of production process control for the reduction of local stocks of precursors.

LEAN MANUFACTURING

A systematic method for the elimination of waste within a manufacturing process. An integrated socio-technical system reduces or minimizes supply-side, customer-side and internal fluctuations.

LEVERAGE

Leverage is a measure of a company's debt and is calculated as the ratio of net debt (without hedging instruments) to adjusted EBITDA over the last 12 months (LTM). For the purpose of a better comparison, adjusted EBITDA LTM includes the companies acquired during the year.

LONG-TERM ASSIGNMENT

Long-term exchange program for employees to promote internal knowledge transfer, intercultural awareness, the development of networks and the individual development of participants.

MATERIAL COST RATIO

The material cost ratio of NORMA Group results from the ratio of material expenses to sales.

NET DEBT

Net debt is the sum of financial liabilities less cash and cash equivalents. Financial liabilities also include liabilities from derivative financial instruments that are held for trading purposes or as hedging instruments.

NET OPERATING CASH FLOW

Net operating cash flow is calculated on the basis of EBITDA plus changes in working capital, less investments from operating activities. Net operating cash flow is a key financial control figure for NORMA Group and serves as a measure for the Group's liquidity.

NORMA VALUE ADDED (NOVA)

A key financial control figure for NORMA Group that serves as a measure for the annual rise in corporate value.

OHSAS 18001

Occupational Health and Safety Assessment Series; certification of occupational health and safety management systems.

ORIGINAL EQUIPMENT MANUFACTURER (OEM)

A company that retails products under its own name.

PRIME STANDARD

A segment of the regulated stock market with higher inclusion requirements than the General Standard. It is the private law segment of the Frankfurt Stock Exchange with the highest transparency standards. All companies listed in the DAX, MDAX, TecDAX and SDAX must be included in the Prime Standard.

REVERSE FACTORING

A financing solution initiated by the ordering party in order to help its suppliers finance their receivables more easily and at a lower interest rate than they would normally be offered.

ROADSHOW

Series of corporate presentations made to investors by an issuer at various financial locations to attract investment in the company.

SECURITIES ID NUMBER (WKN)

A six-character combination of numbers and letters used in Germany to identify securities.



INTRODUCTION

OUR VISION

TO OUR SHAREHOLDERS

CONSOLIDATED
MANAGEMENT REPORT

CONSOLIDATED
FINANCIAL STATEMENTS

FURTHER INFORMATION

207 Glossary

211 List of Graphics

212 List of Tables

215 Overview
by Quarter 2018

216 Multi-Year Overview

218 Financial
Calendar 2019,
Contact and Imprint

SELECTIVE CATALYTIC REDUCTION (SCR)

Selective catalytic reduction is a method used to reduce particle and nitric oxide emissions.

SENIOR FACILITY AGREEMENT (SFA)

Loan agreement.

SMED (SINGLE MINUTE EXCHANGE OF DIE)

Optimization of set up times of processes through both organizational and technical measures.

SOCIETAS EUROPAEA (SE)

Legal form for stock companies in the European Union and the European Economic Area. With the SE, the EU started allowing for companies to be founded in accordance with a largely uniform legal framework at the end of 2004.

SUNSHINE-LINE

A short-term bilateral framework credit line for general company purposes, which can be used as current bank overdrafts as well as in the form of debts or money market loans.

THERMOPLASTS (ALSO KNOWN AS PLASTOMERS)

Plastics which become elastic (thermoplastic) in a particular temperature range, whereby this process is reversible.

WEIGHTED AVERAGE COST OF CAPITAL (WACC)

The weighted average cost of capital (WACC) represents a company's total costs of capital for liabilities and equity depending on the individual capital structure.

WORKING CAPITAL

Trade working capital describes the Group's current net operating assets and is calculated as the sum of inventories and trade receivables minus trade payables.

XETRA

An electronic trading system operated by Deutsche Börse AG for the spot market.



INTRODUCTION

OUR VISION

TO OUR SHAREHOLDERS

CONSOLIDATED
MANAGEMENT REPORT

CONSOLIDATED
FINANCIAL STATEMENTS

FURTHER INFORMATION

207 Glossary

211 List of Graphics

212 List of Tables

215 Overview
by Quarter 2018

216 Multi-Year Overview

218 Financial
Calendar 2019,
Contact and Imprint

LIST OF GRAPHICS

Graphic		Page
Introduction		
G 001	Our Vision	6
To our Shareholders		
G 002	Index-Based Comparison of NORMA Group's Share Price Performance in 2018 with the MDAX and DAX	15
G 003	Distribution of Trading Activity in 2018	16
G 004	Free Float by Region	16
G 005	Analyst Recommendations	17
G 006	Share Price Development of the NORMA Group Share Since the IPO Compared to the MDAX	19
Consolidated Management Report		
G 007	Organizational Structure of NORMA Group	39
G 008	NORMA Group (Simplified Structure)	39
G 009	Sales by Distribution Channel	41
G 010	Strategic Goals of NORMA Group	43
G 011	Important Financial Control Parameters	45
G 012	Development of Sales 2018	58
G 013	Cost of Materials and Cost of Materials Ratio (Adjusted)	59
G 014	Adjusted EBITA and Adjusted EBITA Margin	60
G 015	Asset and Capital Structure	61
G 016	Maturity Profile by Currency	62
G 017	Maturity Profile by Financial Instruments	62
G 018	Breakdown of Sales by Segments	64
G 019	Development of Nickel Prices and the Alloy Surcharge 1.4301	68
G 020	Price Development Technical Polymers (PA66) in Europe	69
G 021	Purchasing Turnover 2018 by Material Groups	69
G 022	Personnel Development at NORMA Group	70
G 023	Breakdown of Employees by Group	70
G 024	Incident Rate	72
G 025	Marketing Expenses 2018 by Segments	73
G 026	Risk Management System of NORMA Group	79



207 Glossary

211 List of Graphics

212 List of Tables215 Overview
by Quarter 2018

216 Multi-Year Overview

218 Financial
Calendar 2019,
Contact and Imprint

LIST OF TABLES

Table		Page
Introduction		
T001	Financial Figures 2018	5
To our Shareholders		
T002	Targets – Results – Outlook	7
T003	Overview of the Voting Rights Notifications	16
T004	Analysts Covering NORMA Group	17
T005	Key Figures for the NORMA Group Share Since the IPO in 2011	19
T006	Responsibilities of the Management Board	26
T007	Other Mandates of the Supervisory Board Members	29
T008	Directors' Dealings	32
Consolidated Management Report		
T009	Overview of End Markets and Brands by Segments	41
T010	Adjusted EBIT after Taxes	46
T011	Capital Employed as of Beginning of the Year (Jan 1)	46
T012	Assumptions for the Calculation of the WACC	46
T013	Financial Control Parameters	47
T014	Non-Financial Control Parameters	47
T015	R&D Key Figures	50
T016	GDP Growth Rates (Real)	51
T017	Actual Business Development Compared to the Forecast	56
T018	Adjustments	57
T019	Effects on Group Sales	58
T020	Development of Sales Channels	58
T021	Return on Capital Employed (ROCE)	60
T022	Development of Segments	65
T023	Strategic Investment Highlights 2018	67
T024	Core Workforce by Segments	70
T025	Forecasts for GDP Growth (Real)	74
T026	Engineering: Real Change in Industry Sales	75
T027	Automotive Industry: Global Production and Development of Sales (Light and Commercial Vehicles)	75
T028	Construction Industry: Development of European Construction Output	76
T029	Forecast for the Fiscal Year 2019	78
T030	Risk and Opportunity Portfolio of NORMA Group	90
T031	Overview of the Matching Stock Program (MSP) at the Time of Allotment	92
T032	Annual Bonus	92

Table		Page
T033	NORMA Value Added Bonus / LTI	93
T034	Management Board Remuneration in 2018	94
T035	Overview of the Promised Pensions of the Board Members	94
T036	Remuneration Granted to the Management Board	95
T037	Inflow from Management Board Member Remuneration	96
T038	Remuneration of the Supervisory Board 2018	97
Consolidated Financial Statements		
T039	Consolidated Statement of Comprehensive Income	106
T040	Consolidated Statement of Financial Position	107
T041	Consolidated Statement of Cash Flows	108
T042	Consolidated Statement of Changes in Equity	109
T043	Retained Earnings Reconciliation: IFRS 9 and IFRS 15	111
T044	Reconciliation Consolidated Statement of Financial Position IFRS 9 and IFRS 15	111
T045	Reconciliation Consolidated Statement of Comprehensive Income IFRS 9 and IFRS 15	112
T046	Financial Assets Reconciliation from IAS 39 to IFRS 9	114
T047	Impairment Reconciliation from IAS 39 to IFRS 9	115
T048	Valuation Methods	119
T049	Exchange Rates	121
T050	Offsetting of Financial Instruments	128
T051	Change in Scope of Consolidation	133
T052	List of Group Companies of NORMA Group as of December 31, 2018	134
T053	Overview of Financial Risks	136
T054	Foreign Exchange Risk	137
T055	Credit Risk Exposure from Cash and Cash Equivalents and other Financial Assets	138
T056	Maturity Structure of Non-Derivative Financial Liabilities	139
T057	Maturity Structure of Derivative Financial Instruments	139
T058	Profit and Loss Net of Adjustments	142
T059	Revenue by Distribution Channel	144
T060	Revenue by Category	144
T061	Raw Materials and Consumables Used	144
T062	Other Operating Income	145
T063	Other Operating Expenses	145
T064	Employee Benefits Expense	146
T065	Financial Income and Costs	146



INTRODUCTION

OUR VISION

TO OUR SHAREHOLDERS

CONSOLIDATED
MANAGEMENT REPORT

CONSOLIDATED
FINANCIAL STATEMENTS

FURTHER INFORMATION

207 Glossary

211 List of Graphics

212 List of Tables

215 Overview
by Quarter 2018

216 Multi-Year Overview

218 Financial
Calendar 2019,
Contact and Imprint

Table		Page
T066	Net Foreign Exchange Gains / Losses	147
T067	Earnings per Share	147
T068	Income Taxes	147
T069	Tax Reconciliation	148
T070	Income Tax Charged / Credited to Other Comprehensive Income	148
T071	Deferred Tax Assets and Deferred Tax Liabilities	149
T072	Movement in Deferred Tax Assets and Liabilities	149
T073	Deferred Income Tax Assets	149
T074	Deferred Income Tax Liabilities	150
T075	Expiry of Recognized Tax Losses	150
T076	Expiry of Not Recognized Tax Losses	150
T077	Development of Goodwill and Other Intangible Assets	151
T078	Goodwill and Other Intangible Assets – Carrying Amounts	152
T079	Change in Goodwill	153
T080	Goodwill Allocation per Segment	153
T081	Goodwill per Segment – Key Assumptions	154
T082	Assumptions Impairment	154
T083	Development of Property, Plant and Equipment	155
T084	Property, Plant and Equipment – Carrying Amounts	156
T085	Finance Leases – Land and Buildings	156
T086	Finance Leases – Machinery	156
T087	Finance Leases – Other Equipment	156
T088	Financial Instruments – Classes and Categories	157
T089	Trade and Other Receivables	159
T090	Trade Receivables	159
T091	Credit Risk Exposure Trade Receivables	160
T092	Impairment Reconciliation	160
T093	Gains/ Losses Arising from Derecognition IFRS 7.20A	160
T094	Other Financial Assets	162
T095	Trade and Other Payables	163
T096	Borrowings	163
T097	Maturity Bank Borrowings 2018	164
T098	Maturity Bank Borrowings 2017	164
T099	Other Financial Liabilities	164
T100	Future Minimum Lease Payments Non-Cancellable Finance Leases	165

Table		Page
T101	Maturity of Financial Liabilities	165
T102	Net Debt	166
T103	Derivative Financial Instruments	166
T104	The Effects of Cash Flow Hedge Accounting on Financial Position and Performance	167
T105	Change in Hedging Reserve Before Tax	168
T106	The Effects of Fair Value Hedge Accounting on Financial Position and Performance	169
T107	Gains and Losses Fair Value Hedges	169
T108	Financial Instruments – Fair Value Hierarchy	170
T109	Financial Instruments – Net Gains and Losses	171
T110	Interest Expenses/Income from Financial Assets and Liabilities (IFRS 7.20(B))	171
T111	Inventories	171
T112	Other Non-Financial Assets	172
T113	Development of Retained Earnings	173
T114	Development of Other Reserves	174
T115	Development of MSP Option Rights	175
T116	Development of LTI	177
T117	Components Pension Liability	178
T118	Reconciliation of the Net Defined Benefit Liability	179
T119	Reconciliation of the Changes in the DBO	179
T120	Reconciliation of Changes in the Fair Value of Plan Assets	180
T121	Disaggregation of Plan Assets	180
T122	Actuarial Assumptions	180
T123	Expected Payments from Post-Employment Benefit Plans	181
T124	Development of Provisions	182
T125	Provisions – Split Current/Non-Current	183
T126	Provisions – Other Personnel-Related	184
T127	Other Non-Financial Liabilities	185
T128	Net Payments for Acquisitions of Subsidiaries	187
T129	Reconciliation of Changes in Assets and Liabilities to Cash Flows from Financing Activities	188
T130	Segment Reporting	189
T131	External Sales per Country	190
T132	Non-Current Assets per Country	190
T133	Commitments	191
T134	Future Minimum Lease Payments of Non-Cancellable Operating Leases	191



Table		Page
T 135	Purchase Price Allocation Kimplas	192
T 136	Purchase Price Allocation Statek	193
T 137	Compensation of Members of the Management Board (IFRS)	193
T 138	Provisions for Compensation of the Management Board Members	194
T 139	Compensation of Board Members	194
T 140	Compensation of Members of the Management Board (§ 315A HGB)	195
T 141	Section 314 para. 1 No 6A HGB: Retirement Benefit Obligations	195
T 142	Fees for the Auditor	196
T 143	Average Headcount	196
T 144	Voting Rights Notifications	197
Further Information		
T 145	Overview by Quarter 2018	215
T 146	Multi-Year Overview	216
T 147	Financial Calendar 2019	218

OVERVIEW BY QUARTER 2018

T 145 OVERVIEW BY QUARTER 2018 ¹

		Q1 2018 ²	Q2 2018 ²	Q3 2018 ²	Q4 2018 ²
Income statement					
Revenue	EUR millions	272.6	276.4	268.1	267.0
Adjusted gross profit	EUR millions	158.7	162.5	158.0	147.3
Adjusted EBITA	EUR millions	45.7	42.0	42.8	42.7
Adjusted EBITA margin	%	16.8	15.2	16.0	16.0
EBITA	EUR millions	44.4	41.0	41.0	38.4
Adjusted profit for the period	EUR millions	29.5	27.3	26.5	31.4
Adjusted EPS	EUR	0.92	0.86	0.83	0.99
Profit for the period	EUR millions	25.0	22.9	21.0	22.9
EPS	EUR	0.78	0.72	0.66	0.72
Cash flow					
Cash flow from operating activities	EUR millions	-5.9	33.1	30.3	73.3
Net operating cash flow	EUR millions	-13.8	30.2	23.0	85.0
Cash flow from investing activities	EUR millions	-12.1	-17.9	-84.1	-15.4
Cash flow from financing activities	EUR millions	1.0	63.7	-39.0	7.5
Balance sheet					
		Mar 31, 2018	Jun 30, 2018	Sep 30, 2018	Dec 31, 2018
Total assets	EUR millions	1,307.6	1,431.8	1,435.7	1,471.7
Equity	EUR millions	552.6	555.1	574.8	602.4
Equity ratio	%	42.2	38.8	40.0	40.9
Net debt	EUR millions	361.5	392.0	457.8	400.3

1_Minor deviations may occur due to commercial rounding for the full year 2018 compared with the summation of the corresponding quarterly amounts.

2_The adjustments are described in the Notes. ► **NOTES, P. 141**



MULTI-YEAR OVERVIEW

T 146 MULTI-YEAR OVERVIEW ¹

		2018 ²	2017	2016	2015	2014	2013	2012 ³	2011
Order situation									
Order book (Dec 31)	EUR millions	379.2	329.1	302.4	295.8	279.6	236.7	215.4	218.6
Income statement									
Revenue	EUR millions	1,084.1	1,017.1	894.9	889.6	694.7	635.5	604.6	581.4
thereof EMEA	EUR millions	494.8	485.9	432.0	416.0	394.5	388.0	367.5	372.7
thereof Americas	EUR millions	441.5	411.3	381.6	395.3	237.8	191.5	193.3	173.0
thereof Asia-Pacific	EUR millions	147.8	119.9	81.3	78.2	62.5	56.0	43.8	35.7
EJT	EUR millions	684.6	638.2	535.9	540.3	481.0	443.9	427.6	411.5
DS	EUR millions	393.8	372.3	354.5	344.1	211.5	193.6	174.5	170.3
Adjusted gross profit	EUR millions	626.6	601.3	545.6	533.1	405.6	371.4	344.4	322.6
Adjusted EBITA	EUR millions	173.2	174.5	157.5	156.3	121.5	112.6	105.4	102.7
Adjusted EBITA margin	%	16.0	17.2	17.6	17.6	17.5	17.7	17.4	17.7
EBITA	EUR millions	164.8	166.8	150.4	150.5	113.3	112.1	105.1	84.7
EBITA margin	%	15.2	16.4	16.8	16.9	16.3	17.6	17.4	14.6
Adjusted profit for the period	EUR millions	114.8	105.0	94.6	88.7	71.5	62.1	61.8	57.6
Profit for the period	EUR millions	91.8	119.8	75.9	73.8	54.9	55.6	56.6	35.7
Adjusted EPS	EUR	3.61	3.29	2.96	2.78	2.24	1.95	1.94	1.92
EPS	EUR	2.88	3.76	2.38	2.31	1.72	1.74	1.78	1.19
Financial result	EUR millions	-11.7	-16.1	-14.6	-17.2	-14.5	-15.6	-13.2	-29.6
Adjusted tax rate	%	24.9	30.0	28.9	32.1	33.3	32.6	30.3	30.0
R&D expenses	EUR millions	30.5	29.4	28.8	25.4	25.7	21.9	22.1	16.8
R&D ratio (in relation to EJT sales)	%	4.5	4.6	5.4	4.7	5.3	4.9	5.1	4.1
(Adjusted) cost of materials	EUR millions	473.1	418.6	352.9	362.9	289.9	269.4	263.5	262.3
(Adjusted) cost of materials ratio	%	43.6	41.2	39.4	40.8	41.7	42.4	43.6	45.1
(Adjusted) Personnel expenses	EUR millions	280.8	269.6	243.9	234.1	188.3	169.7	156.5	143.7
(Adjusted) personnel cost ratio	%	25.9	26.5	27.3	26.3	27.1	26.7	25.9	23.8

Continued on next page ►

1_Key figures prior to the IPO in 2011 are not shown due to lack of comparability between HGB and IFRS. For this reason, the multi-year-overview includes only the years from 2010 onwards.

2_In 2018, adjustments were made which especially relate to the acquisitions and the rightsizing program which was initiated in the fourth quarter of 2018. The adjustments are described in the Notes.

► **NOTES, P. 141** The adjustments of prior years can be found in the corresponding Annual Reports.

3_2012: The accounting rules changed in 2013 due to the first-time use of IAS 19R. In order to better compare the earnings, assets and financial positions, the 2012 figures have been adjusted to suit the new accounting rules and may therefore deviate from the figures published in the 2012 Annual Report.

INTRODUCTION

OUR VISION

TO OUR SHAREHOLDERS

CONSOLIDATED
MANAGEMENT REPORT

CONSOLIDATED
FINANCIAL STATEMENTS

FURTHER INFORMATION

207 Glossary

211 List of Graphics

212 List of Tables

215 Overview
by Quarter 2018

216 Multi-Year Overview

218 Financial
Calendar 2019,
Contact and Imprint

T 146 MULTI-YEAR OVERVIEW (CONTINUED)

		2018	2017	2016	2015	2014	2013	2012	2011
Cash flow									
Cash flow from operating activities	EUR millions	130.8	146.0	149.2	128.2	96.4	115.4	96.1	71.7
Net operating cash flow	EUR millions	124.4	132.9	148.5	134.7	109.2	103.9	81.0	66.8
Cash flow from investing activities	EUR millions	-129.5	-70.8	-133.8	-44.5	-265.1	-43.4	-58.1	-33.7
Cash flow from financing activities	EUR millions	31.3	-77.7	49.6	-70.4	57.7	51.7	-34.1	-0.5
Balance sheet									
Total assets	EUR millions	1,471.7	1,312.0	1,337.7	1,167.9	1,078.4	823.7	691.8	648.6
Equity	EUR millions	602.4	534.3	483.6	429.8	368.0	319.9	289.2	256.0
Equity ratio	%	40.9	40.7	36.2	36.8	34.1	38.8	41.8	39.5
Net debt	EUR millions	400.3	344.9	394.2	360.9	373.1	153.5	199.0	198.5
Working capital	EUR millions	179.2	158.2	144.5	151.9	141.8	110.8	115.9	106.2
Working capital ratio	%	16.5	15.6	16.1	17.1	20.4	17.4	19.2	18.3
Employees									
Core workforce		6,901	6,115	5,450	5,121	4,828	4,134	3,759	3,415
Total workforce incl. temporary workers		8,865	7,667	6,664	6,306	5,975	4,947	4,485	4,252
Share									
Number of shares (weighted)		31,862,400	31,862,400	31,862,400	31,862,400	31,862,400	31,862,400	31,862,400	30,002,126
Number of shares (year-end)		31,862,400	31,862,400	31,862,400	31,862,400	31,862,400	31,862,400	31,862,400	31,862,400



207 Glossary

211 List of Graphics

212 List of Tables

215 Overview
by Quarter 2018

216 Multi-Year Overview

**218 Financial
Calendar 2019,
Contact and Imprint**

FINANCIAL CALENDAR, CONTACT AND IMPRINT

T 147 FINANCIAL CALENDAR 2019

Date	Event
May 8, 2019	Publication of Interim Statement Q1 2019
May 21, 2019	Ordinary Annual General Meeting 2019, Frankfurt
Aug 6, 2019	Publication of Interim Report Q2 2019
Nov 6, 2019	Publication of Interim Statement Q3 2019

The financial calendar is constantly updated. Please visit the Investor Relations section on the Company website www.investors.normagroup.com.

EDITOR

NORMA GROUP SE

Edisonstrasse 4

63477 Maintal

Phone: +49 6181 6102 740

E-mail: info@normagroup.comwww.normagroup.com

CONTACT

E-mail: ir@normagroup.com

CONTACT PERSONS

ANDREAS TRÖSCH

Vice President Investor Relations

Phone: +49 6181 6102 741

E-mail: andreas.troesch@normagroup.com

VANESSA WIESE

Senior Manager Investor Relations

Phone: +49 6181 6102 742

E-mail: vanessa.wiese@normagroup.com

CHIARA VON EISENHART ROTHE

Manager Investor Relations

Phone: +49 6181 6102 748

E-mail: chiara.voneisenhartrothe@normagroup.com

DESIGN AND REALIZATION

MPM Corporate Communication Solutions, Mainz, Düsseldorf

EDITING

NORMA Group

MPM Corporate Communication Solutions, Mainz, Düsseldorf

PHOTO CREDITS

NORMA Group

Note on the Annual Report

This Annual Report is also available in German. If there are differences between the two, the German version takes priority.

Note on rounding

Please note that slight differences may arise as a result of the use of rounded amounts and percentages.

Forward-looking statements

This Annual Report contains certain future-oriented statements. Future-oriented statements include all statements which do not relate to historical facts and events and contain future-oriented expressions such as 'believe,' 'estimate,' 'assume,' 'expect,' 'forecast,' 'intend,' 'could' or 'should' or expressions of a similar kind. Such future-oriented statements are subject to risks and uncertainties since they relate to future events and are based on the Company's current assumptions, which may not in the future take place or be fulfilled as expected. The Company points out that such future-oriented statements provide no guarantee for the future and that the actual events including the financial position and profitability of NORMA Group SE and developments in the economic and regulatory fundamentals may vary substantially (particularly on the down side) from those explicitly or implicitly assumed in these statements. Even if the actual assets for NORMA Group SE, including its financial position and profitability and the economic and regulatory fundamentals, are in accordance with such future-oriented statements in this Annual Report, no guarantee can be given that this will continue to be the case in the future.

DATE OF PUBLICATION

March 20, 2019



NORMA Group SE

Edisonstraße 4
63477 Maintal

Phone: + 49 6181 6102 740

E-mail: info@normagroup.com

Internet: www.normagroup.com